

TOTO

Head Office

TOTO Europe GmbH
Zöllhof 2, 40221 Düsseldorf Germany
Tel: +49 (0)700 8686 0700
E-Mail: teu.information@toto.com

TOTO

Instruction Manual

NEOREST WX



NEOREST

WX2 TCF95280GEU
WX1 TCF95180GEU



You are advised to record the following information to allow quick service.

Date of purchase :	Name of shop :
Date : year month day	
	Tel :

Thank you for your recent purchase of this product.
Please read the enclosed information to ensure the safe use of your product.
Be sure to read this Instruction Manual before using your product and keep it in a safe place for future reference.

Table of Contents

Introduction

Safety Precautions	4
Operational Precautions	8
Parts Names	10
Preparation	12
Using the Product for the First Time	12
How to turn off the product	14

Operation

Basic Operations	15
Mechanism of Auto Functions	15
Auto open / close	15
Auto bowl CLEAN	15
Deodorizer	15
Auto power deodorizer	15
Auto flushing	15
Auto wand CLEAN	16
Photocatalyst cleaning	16
Soft light	17
CLEAN indicator	17
Using the Remote Control	18
Stop	18
Rear washing	18
Rear soft washing	18
Front washing	18
Water pressure adjustment	18
Wand position adjustment	18
Drying	18
Oscillating washing	18
Pulsating washing	18
Full flush	19
Light flush	19
Wand CLEAN	19
Personal setting	19
Opening and closing the toilet lid	19
Opening and closing the toilet seat	19
Low battery warning LED	19
Menu, Return button	19
Temperature adjustment button	19
Power ON/OFF button	19
SELECT keys	19
Enter button	19
Display screen	19
About the Menu Screen	20

Temperature Adjustment	22
Warm water / Toilet seat / Drying	22
Changing Settings	24
Setting List	24
The energy saver features	26
How to Set	28
Auto energy saver	28
Auto energy saver+	28
Timer energy saver	29
Auto flushing	29
Auto flush delay	30
Auto flush lid closed	30
Auto open / close	32
Auto close delay	32
Auto open delay	33
Seat/lid	34
Auto wand CLEAN	34
Auto bowl CLEAN	35
Deodorizer	36
Auto power deodorizer	36
Night light	37
Soft light	38
Bowl light	38
CLEAN indicator	39
Language settings	39
Beep sound	40
Pressure/position setting	40
Personal setting	41
Registering Personal Settings	42
Sensor detection range	43

Maintenance

Maintenance	44
Before maintenance	44
Top Unit	45
Bowl Unit	46
Manual Spray	47
Wand	48
Wand cleaning	48
Deodorizing Filter	49
Descaling	50
Descaling mode	52
Drain Plug with Water Supply Filter	56
Spray Nozzle	57

Reference

What to Do?	59
If there is no water due to a power outage or water failure	59
If a power outage occurs	59
If a water outage occurs	59
If you cannot operate with the remote control	59
Replacing the batteries	59
Freeze Damage Prevention	60
Long Periods of Disuse	61
How to drain the water	61
Resupplying the Water	62
Removal of Operation Guide	63
Troubleshooting	64
Please check first	64
Rear Washing, Front Washing and Wand	65
Warm air drying	66
Flushing	66
Toilet Seat and Toilet Lid (Auto open/close)	68
Toilet Seat and Toilet Lid	69
Auto flush lid closed	69
Energy Saver	70
Deodorizer	70
Auto bowl CLEAN	71
Light	71
Others	72
Specifications	74
Safety Guidelines	76
Warranty	77
Important User Guidance Information	79



The available functions vary according to the part no.

Functions	Part No.*1	
	TCF95280GEU	TCF95180GEU
Photocatalyst cleaning	●	-

*1 The part no. is on the toilet lid label. (→Page 10)

Safety Precautions

These precautions are important for safe usage. Be sure to follow them and use the product correctly. The following symbols are used to indicate important safety instructions for the use of the product.

Symbol	Meaning
 WARNING	May result in death or serious injury.
 CAUTION	May result in injury or property damage.

WARNING

Never disassemble, repair or alter.

Doing so may cause fire, electrical shock, overheating, short circuit or breakdown.

Do not use the product if a malfunction occurs.

In case of breakdown or other problems, be sure to cut off power, by flipping the power switch to OFF or switching the breaker on the distribution board to OFF, etc.

Close the water shutoff valve to stop water supply.

Possible malfunctions:

- Water is leaking from a pipe or the top unit
- The product is cracked or broken.
- The product makes a strange noise or emits a strange odor.
- The product emits smoke.
- The product is abnormally hot.
- The bowl unit is clogged.
- The toilet seat cushion is out of place.

Continued use after malfunction could cause a fire, electric shock, heat, short circuit, injury or water damage.

Do not use other water than allowed by the laws and ordinances of the region of use. Only Use potable water.

Do not use seawater or recycled water.

Doing so may cause irritation to the skin and malfunction.

Keep cigarettes and other open flames away from the product.

Failure to do so may cause fire.

Refrain from sitting on the seat for long periods.

It may cause low-temperature burns.

To prevent the following persons from getting a moderate temperature burn during use, other person should turn off the toilet seat heater.

- Young children, the aged and other users unable to set the temperature appropriately themselves.
- The ill, physically disabled and others who do not have freedom of movement.
- Those using any medicines that cause drowsiness (sleeping or cold medicine), those who have been drinking heavily, anyone severely fatigued and anyone else liable to fall asleep.

If the power cord is damaged, avoid danger by having the manufacturer's repair department or equivalent specialist replace it.

Turn the power OFF before maintenance or inspection.*1

Failure to do so may cause electrical shock or malfunction.

When leaking battery fluid adheres to your body or clothes, wash it away with clean water.

The fluid may damage your eyes or skin.

WARNING

Do not install the product on moving vehicles such as wheeled vehicles or boats.

Doing so may cause fire, electric shock, short circuit or malfunction.

The toilet seat, toilet lid, top unit, or other parts may come loose and fall off, resulting in injury.

Do not use any power supply other than the one specified.

AC 220–240 V, 50 Hz

Doing so may cause fire or excessive heat.

This is an electrical product. Do not install it anywhere water is likely to get on the product or anywhere with humidity high enough that water is likely to form on the surface of this product. When using the product in a bathroom, install a fan or ventilation port and ensure good air flow through the bathroom.

Failure to do so may cause fire or electrical shock.

Always connect the product to the cold water supply.

Connecting to hot water supply may result in burns and equipment damage.

Do not stick a finger or anything else into the warm air outlet.

Do not place anything on the warm air outlet or drape clothes over it.

Doing so may cause burns, electrical shock or malfunction.

Preliminary studies in females suggest that overuse of continuous spraying can increase the possibility of vaginal mucosa drying and potential reduction in desirable microbial organisms. Although these studies have not been validated, please consult your healthcare provider for concerns regarding whether these circumstances may apply to you.

More importantly, if you are an individual suffering from any immune deficiency as a result of disease, chemotherapy, or other medical condition compromising the immune system you should consult your healthcare provider before use of this product.

This appliance is not intended for use by persons (including children) with reduced physical, sensory or mental capabilities, or lack of experience and knowledge, unless they have been given supervision or instruction concerning use of the appliance by a person responsible for their safety.

Children should be supervised to ensure that they do not play with the appliance.

Do not look directly at UV lamp.*2

May cause eye or skin irritation.

There are no user replaceable parts. Shall be serviced by qualified personnel only.

*1 How to turn off the product (→Page 14)

*2 For units with the "Photocatalyst cleaning" function only.

Safety Precautions

CAUTION

Do not use the product if the top unit is unstable.

Doing so may cause the top unit to come loose and fall, resulting in injury.

If the product is damaged, do not touch the damaged section.

Doing so may cause electrical shock or injury. Replace it immediately.

Do not apply strong force, mechanical shock, step on or stand on the toilet seat, toilet lid or top unit. Also do not place any heavy object on the toilet seat, toilet lid or top unit. Do not sit on the toilet lid.

Doing so may cause cracking or cause the top unit to come loose and fall, resulting in injury.

Doing so may damage the product and cause injury or water damage.

When maintaining the plastic parts (top unit etc.) or the water supply hose, use a pH neutral kitchen detergent diluted with water. Do not use any of the following.

Toilet cleaner, household cleaner, benzene, paint thinner, powdered cleanser or nylon scrubbing brush.

These items may damage or crack the plastic and cause injury or malfunction.

These items could damage the water supply hose and cause a water leak.

To prevent a sudden water leak, do not remove the Drain plug with water supply filter when the shutoff valve is open.

Doing so will cause water to spurt out.

(→Refer to Page 56 for instructions on cleaning the Drain plug with water supply filter.)

Do not fold or crush the water supply hose; do not damage by cutting with a sharp object.

Doing so may cause water leaks.

Do not pour hot water into the toilet.

Doing so may result in damage to the toilet, injury or water damage.

Keep the bowl filled with water.

Failure to do so may cause sewer gas, chlorine gas, or hydrogen sulfide to corrode facilities and equipment.

Do not flush anything other than bodily waste and toilet paper. Also, do not flush too much toilet paper. Do not flush the bowl unit if it is clogged.

Doing so may clog the toilet, causing waste water overflow and water damage.

Always flush, even after just urinating.

Failure to do so may clog the toilet, causing waste water overflow and water damage or inadequate flushing of the bowl unit.

Wipe condensation on the bowl unit, tank, water supply pipe and shutoff valve with a dry cloth.

Condensation may cause staining and corrosion of the floor. Ventilate the restroom to prevent condensation.

Wipe any urine, condensation, cleaner, water, etc. that has gotten on the floor with a well-wrung mop or cloth.

Failure to do so may cause staining and corrosion of the floor.

If a water leak should occur, always close the shutoff valve.

When the ambient temperature is likely to drop to 0 °C or lower, prevent damage to the pipes and hoses due to freezing.

Frozen water pipes could cause the top unit and the pipes to break, resulting in a water leak.

Regulate the room temperature to prevent the pipes and hoses from freezing during cold months.

Drain the water.

CAUTION

When not using the product for a long time, close the shutoff valve, drain the water from the top unit and water supply hose, and then turn the power OFF.*1

When using the product again, allow the product to refill with water first. Otherwise, the water in the tank might become contaminated and cause skin inflammation or other problems. (→Refer to Page 62 for instructions on replenishing the water.)

Leaving the power on may cause fire or heat.

When installing the Drain plug with water supply filter, make sure that it is securely tightened in its proper position.

Failure to securely tighten it may cause a water leak.

If the bowl is clogged, turn the power OFF*1 and remove the clog.

If the "Auto flushing" is activated, it would make the wastewater in the bowl unit overflow and may result in water damage.

Use commercially available tools that are made for unclogging the bowl unit to remove the clogging.

Make sure of the plus and minus signs on the batteries before inserting them.

Remove depleted batteries immediately.

When replacing the batteries:

- Replace both batteries with new ones.
- Use the same brand for both new batteries (any brand available).

Failure to do so may cause the batteries to leak fluid, generate heat, rupture, or ignite.

When the product is supposed not to be used for long time, remove the batteries from the remote control.

Failure to do so may cause the batteries to leak fluid.

This product is classified as Class I Equipment and must be grounded.

Install this equipment so that its power breaker is accessible.

Use the new hose set included with this equipment. Do not reuse an old hose set.

*1 How to turn off the product (→Page 14)

Operational Precautions

For prevention of damage

Wipe plastic areas such as the top unit and remote control with a soft cloth tightly wrung out with water.

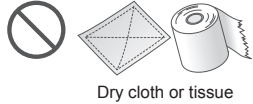

Dry cloth or tissue

Do not lean against the toilet lid.



For prevention of malfunctions and failures

Turn the power OFF if there is a risk for lightning strike.*1

A toilet seat cover or a toilet lid cover cannot be used.

Otherwise, the seat sensor may not detect properly. Additionally, the toilet seat and lid may not open or close properly.



Covers

Do not urinate on the top unit, toilet seat or wand.

Doing so may cause a failure or discoloration.

Do not apply strong forces to the control panel of the remote control.

When using a toilet cleaner to clean the toilet, rinse it off within 3 minutes and leave the toilet seat and toilet lid open.

If vapor from a toilet cleaner enters the top unit, it may cause a malfunction.

► Wipe off any cleaner that remains on the bowl unit.

Note: If "Auto flush lid closed" (→ Pages 30, 31) is turned ON and you use the remote control to flush the bowl unit, the toilet seat and lid close before flashing the bowl unit.

After the bowl unit has been flushed, open the toilet seat and lid.

Do not expose to direct sunlight.

Doing so may cause changes in color, irregular heated seat temperature or remote control malfunction.

Use radios, etc. away from the product.

The product could cause interference with the radio signal.

If you use a booster seat for infants or a soft highchair, remove it after use.

Keeping it installed may prevent some of the functions from being used.

Do not apply force to the remote control.

This cause malfunction.

► To prevent the remote control from being dropped, set it in the hanger when you are not using it. Be careful not to expose it to water.

Do not place anything on the toilet seat, and do not press them with hands.

Doing so may activate the seat sensor, causing the floor to get wet if buttons on the remote control are touched and warm water comes out from the wand.

This product is intended for use up to a maximum height of 2,000 m above sea level.

About the built-in body sensor

The body sensor detects human movement. The toilet lid opening or "Auto bowl CLEAN" operation may be triggered by someone outside the bathroom as the sensor detects human movement through the door or wall in front of the top unit.

The sensor may not detect properly depending on the bathroom layout, resulting in the toilet lid not opening automatically.

For someone small such as a child, the body sensor may not detect properly, resulting in the toilet lid not opening automatically.

When you are using the toilet in standing position, the length of time it takes for "Auto flushing" to complete or for the toilet lid or seat to close automatically depends on the bathroom layout, etc.

About the built-in seat sensor

When you sit on the toilet seat, the seat sensor turns ON, enabling you to use various features. (The deodorizer starts when the seat sensor makes a detection.)

A label indicating the position of the seat sensor is attached to the seat.

Detection by the sensor may be difficult when the toilet is used by someone small, such as a child, depending on how the person sits.

► Sit on the seat with the label as a guide. (The label can be peeled off).

Sit so your skin is in direct contact with the seat sensor.

The seat sensor may not detect properly if there is a seat cover or clothing. If you use the booster seat for infants, the seat sensor may not detect properly, resulting in the toilet lid closing automatically during use.

► Turn "Auto open / close" OFF before use.

Water droplets collecting on the seat sensor may cause the top unit to malfunction.

► Be sure to wipe off any water droplets on the sensor. Do not use items that cause damage, such as toilet paper. (→Page 45)

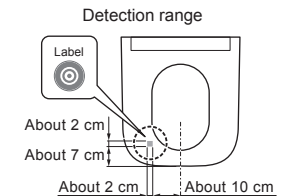

*1 How to turn off the product (→Page 14)

Parts Names

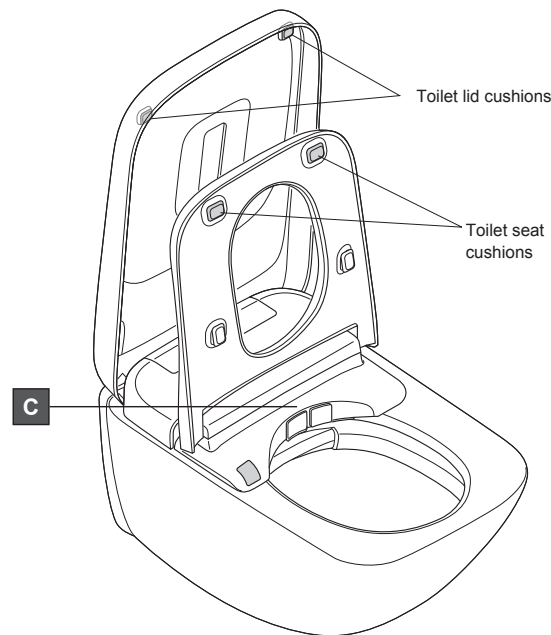
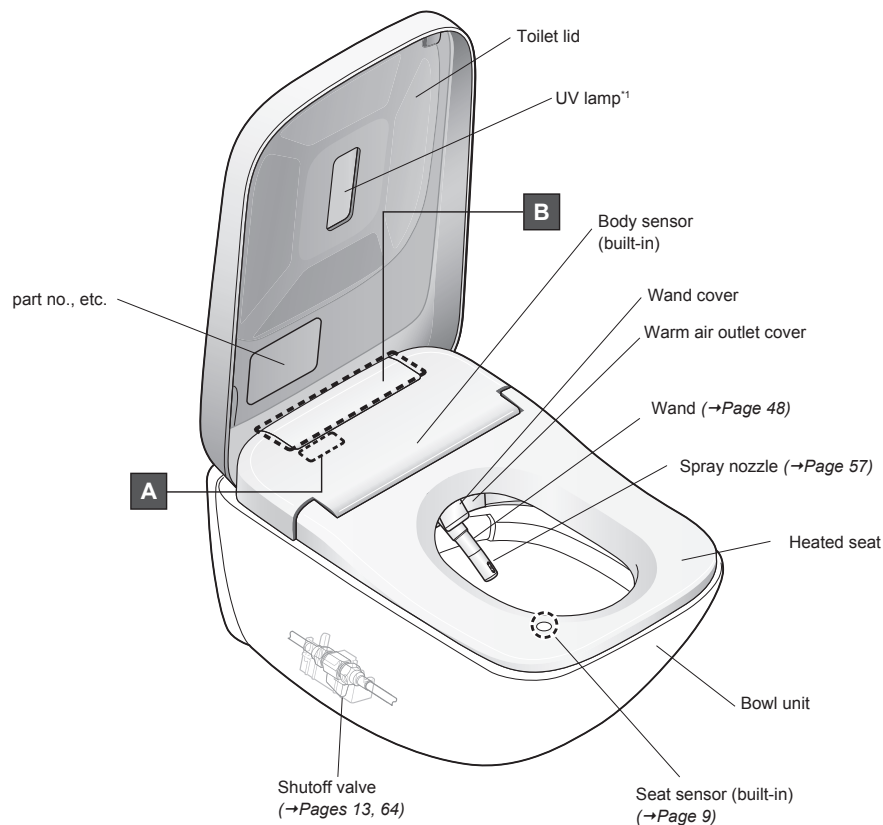

A: Main display

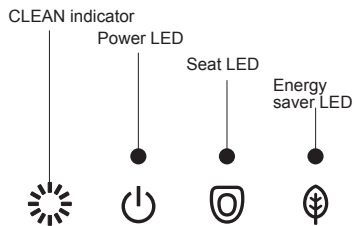

<All the CLEAN indicator and LEDs light up in the figure>

B: Top side of the top unit

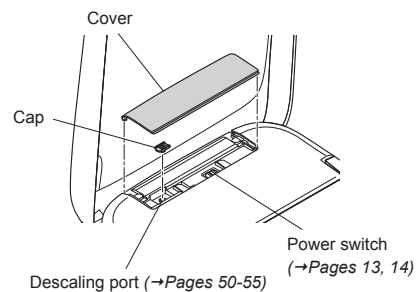

C: Front side of the top unit

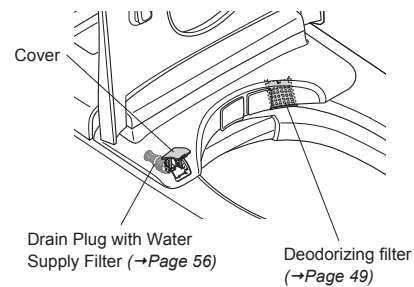

TCF95180GEU

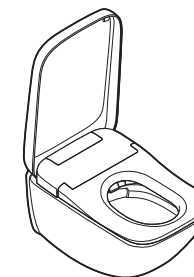

The toilet lid shape varies by model.

Descriptions in this manual are based on the illustration of TCF95280GEU.

*1 For units with the "Photocatalyst cleaning" function only.

Preparation

Using the Product for the First Time

1. Insert the battery

1.1 Remove the remote control from the hanger.

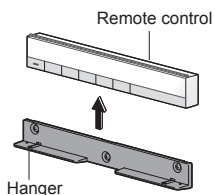

1.2 Open the battery cover and insert two AA batteries. Insert batteries and close the battery cover.

Remote control back side

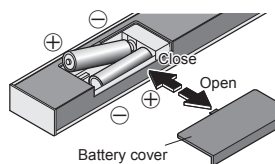

► When batteries are properly inserted, temperature levels appear on the display of the remote control (back side).

When the temperature levels are not displayed.

Perform step 3 of "Language settings".
(→Page 39)

The display goes out when no button on the remote control is pressed for about 60 seconds or more.

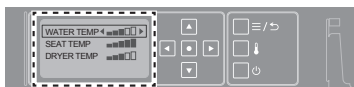

1.3 Mount the remote control in the hanger.

About the batteries

Use dry cell, alkaline batteries.

Be sure to follow "Safety Precautions" to prevent the batteries from rupturing or leaking fluid. (→Pages 4, 7)

If the remote control is secured to prevent theft

1) Remove the screw from the remote control fixture.
(2 pieces, left and right)

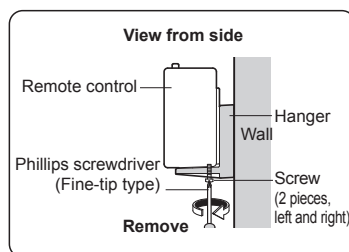

2) Remove the remote control from the hanger.

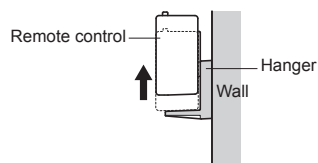

To secure the remote control again

Tighten two screws on the left and right to secure it.
Overtightening may cause damage to parts such as the hanger.

2. Turn on the power

2.1 Switch the breaker on the distribution board to ON.

► The wand extends and then retracts.

2.2 Check the "Power" LED illuminates.

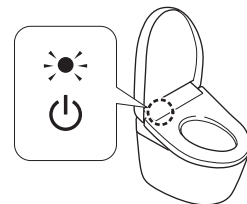

If the light is off

1) Remove the cover on the top of the unit, and flip the power switch to "ON".

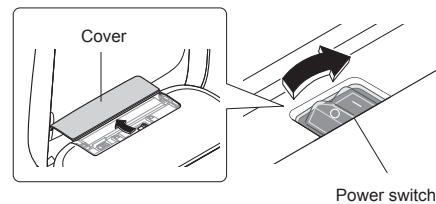

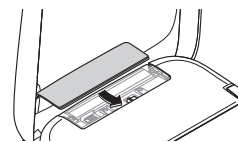

2) Reinstall the cover.



If the light is off, but the power switch is "ON"



Switch "Power" to "ON" using the remote control.

To operate from the back of remote control

1)  
Press "Power ON/OFF" button about 3 seconds or longer.

To operate from the front of remote control

Recommended if the remote control is secured to prevent theft, etc.

1)  and 
Press the "Stop" button and "Water pressure adjustment +" button at the same time for about 10 seconds or longer.

3. Open the shutoff valve

3.1 Fully open the shutoff valve.

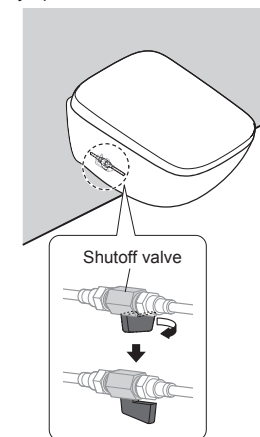

Preparation

How to turn off the product

To turn the power "OFF"

- 1) Remove the cover on the top of the unit, and flip the power switch to "OFF".
▶ The "Power" LED is unilluminated.

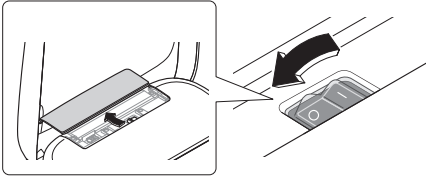

- 2) Reinstall the cover. (→Page 13)

Basic Operations

Mechanism of Auto Functions

"EWATER+" is used automatically to clean the wand and bowl unit.

1. As you approach

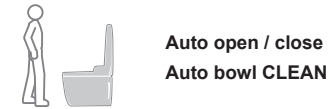

Auto open / close

The toilet lid opens



When the toilet is used in standing position

Open the toilet seat with the remote control.

Auto bowl CLEAN

Pre-mist

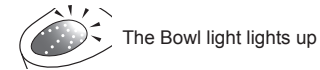

A mist is automatically sprayed inside the bowl unit to make it more difficult for dirt to adhere.

2. As you sit*1



Deodorizer

Deodorizer

Starts the deodorizer



Removing odors inside the bowl unit.

Note: Deodorizing filter needs regular maintenance. (→Page 49)

3. As you stand up*1



Auto power deodorizer
Auto flushing
Auto wand CLEAN
Auto bowl CLEAN

Auto power deodorizer

After about 10 seconds

Starts the auto power deodorizer



It stops about 60 seconds after you stand up from the toilet seat.

Auto flushing

After about 10 seconds

The toilet flushes*2

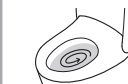

Note: The flushing varies depending on how long you sit on the toilet seat.

- Performs a light flush if the time is about 6 to 30 seconds.
- Performs a full flush if the time is about 30 seconds or longer.

*1 Water comes out from around the wand.

*2 You can change to the setting that closes the toilet lid before flushing the bowl unit. (→Page 30)

Basic Operations

Auto wand CLEAN

Only when the washing functions are used.

After about 25 seconds

The wand extends to clean itself with "EWATER+" that comes out of the base*1

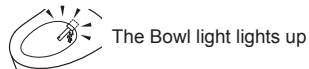

The Bowl light lights up

Note: "EWATER+" can also be used by pressing the remote control button. (→Page 19 "Wand CLEAN")

Auto bowl CLEAN

After cleaning the wand

After-mist "EWATER+" mist is sprayed on the bowl unit*1

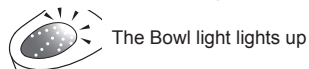

The Bowl light lights up

Note: If washing functions are not used, after-mist is performed approximately 25 seconds after standing up from the toilet seat.

Note: "EWATER+" can also be used by pressing the remote control button. (→Page 47 "Manual spray")

4. As you move away

When you move away



- Auto flushing
- Auto open / close
- Photocatalyst cleaning

When the toilet is used in standing position

Auto flushing

The toilet flushes*2



Performs a light flush.

Auto open / close

The toilet lid and toilet seat close*2



Auto open / close*3

The toilet lid closes*2



Photocatalyst cleaning*4

The UV lamp lights up
(For about 1 hour)

Operation under the default settings is described in "Mechanism of Auto Functions".

These mechanisms be changed.
(→Pages 24–43 "Changing Settings")

What is meant by "EWATER+" ?

This water containing hypochlorous acid generated from chloride ions in tap water, is widely used for cleaning and disinfecting items such as food, utensils and baby bottles.

- Well water may not deliver the required effect. (Because the level of chloride ions is low.)
- "EWATER+" helps to minimize dirty surfaces, but does not eliminate the need to clean completely.
- The effect and duration vary depending on the usage environment and conditions.

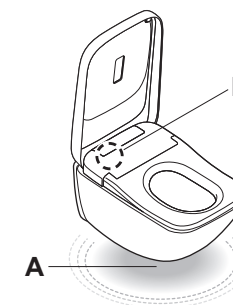

A Soft light

Lighting up the inside of the bathroom with a soft light.

It lights up as you approach the bowl unit and goes off after you move away from the unit and a certain time has passed.

Note: You can turn "Soft light" ON or OFF.
(→Page 38)

Night light

You can change "Soft light" and "Bowl light" to "Night mode", a lighting mode suitable for night. (→Page 37)

B CLEAN indicator

Lights to show that the "Auto bowl CLEAN", "Deodorizer", "Auto wand CLEAN", and "Manual spray" functions are operating.

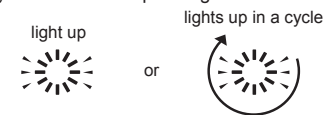

(Lights only when the toilet seat is not in-use)*5

Note: You can turn "CLEAN indicator" ON or OFF.
(→Page 39)

*1 If the washing function (Rear washing and Front washing etc.) is not used for about 8 hours, the following operations will occur.

•Auto wand CLEAN: The wand is cleaned automatically and water comes out from around the wand.

•Auto bowl CLEAN: Mist is sprayed on the bowl unit automatically.

► You can turn it "OFF". (→Page 73 "The top unit makes a sound" and "When not using the product (e.g., at night)")

*2 You can change to the setting that closes the toilet lid before flushing the bowl unit. (→Page 30)

*3 When you do not sit on the toilet seat, or when you sit on it or stand in front of the bowl unit briefly, it takes about 5 minutes before the lid close automatically.

*4 Except TCF95180GEU

*5 Except "Manual spray"

Basic Operations

Using the Remote Control

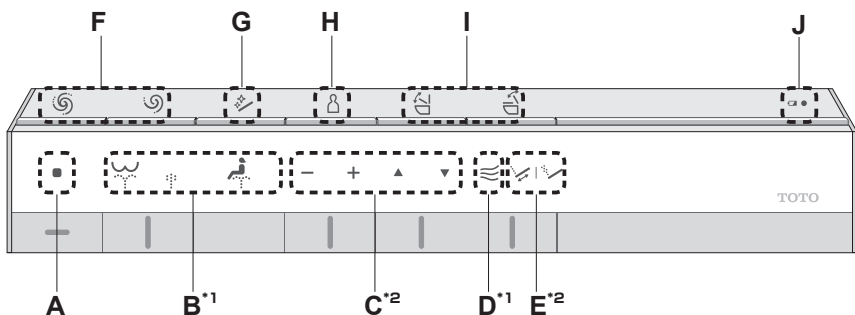

Operate the controls on the remote control; a beep sounds when the top unit receives the signal.

- A** **Stop**
Stops the B or D operation.

- B** **Rear washing**
Washes your rear.
- Rear soft washing**
Washes your rear with mild water pressure.

- Front washing**
Serves as a bidet for ladies.

- C** **Water pressure adjustment**
You can adjust the water pressure to one of five levels.
[-] Softer, [+] Stronger

- Wand position adjustment**
You can adjust the washing position to 5 different points between the front and the rear, using the [▲] and [▼] buttons.

Once use of the remote control is finished, the settings will return to the initial setting (3rd position) after a while, not exceeding a maximum of 5 minutes.

If you do not want to return to 3rd position (→Page 40)

Note: *Sitting back on the toilet seat makes it easier to adjust the wand position and to reduce splashing.*

- D** **Warm air drying**
Dries your rear.

- E** **Oscillating washing**
The wand moves back and forth to wash your rear thoroughly.
- Pulsating washing**
Washes with the water pressure pulsating between soft and strong.

The washing mode changes each time you press the button.

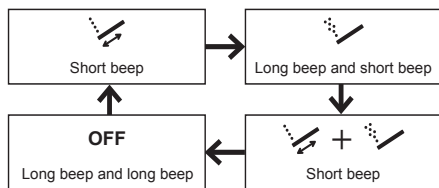

Note: *Sitting back on the toilet seat makes it easier to adjust the wand position and to reduce splashing.*

- F** **Full flush**^{*3}
Performs a full flush.
- Light flush**^{*3}
Performs a light flush.

- G** **Wand CLEAN**
Cleans the wand with "EWATER+"^{*4}.
After wand cleaning, water comes out from around the wand.
Note: *This function will operate automatically after using the washing functions (Rear washing, Front washing, etc.). (→Page 34 "Auto wand CLEAN")*
Note: *To clean the wand with it extended. (→Page 48 "Wand cleaning")*

- H** **Personal setting**
Up to four people can register their preferred "Water pressure", "Wand position" and "Warm water temperature" settings. (→Page 42)
To use
1) Press the button and check the beep sound to select the register number.
REGISTER 1: One short beep
REGISTER 2: Two short beeps
REGISTER 3: Three short beeps
REGISTER 4: Four short beeps
2) Press the wash button you want to use ("Rear washing", etc.)

- I** **Opening and closing the toilet lid**
Opens and closes the toilet lid.
- Opening and closing the toilet seat**
Opens and closes the toilet seat.

- J** **Low battery warning LED**
(→Page 59)

Remote control back side

How to remove the remote control (→Page 12)

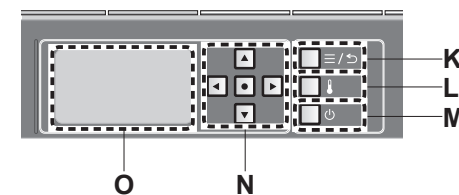

- K** **"Menu, Return" button**
Adjust settings
Return to the previous menu

- L** **"Temperature adjustment" button**
Adjust temperatures (→Pages 22, 23)

- M** **Power ON/OFF**
Pressing it about 3 seconds or longer turns the power on/off.
▶ If the remote control is secured to prevent theft (→Page 13 Step 2.2.2)

- N** **SELECT keys**
Select settings.

- Enter button**

- O** **Display screen**

*1 This cannot be used if the seat sensor is not working. Sit so your skin is in direct contact with the seat sensor. (→Page 9)

*2 While using B, these buttons and their functions can be operated.

*3 You can change to the setting that closes the toilet lid before flushing the bowl unit. (→Page 30)

*4 What is meant by "EWATER+" ? (→Page 17)

Basic Operations

About the Menu Screen

This section is an overview of the settings that can be configured with the remote control. See the corresponding pages for the detailed descriptions.

Remote control back side

How to remove the remote control (→Page 12)

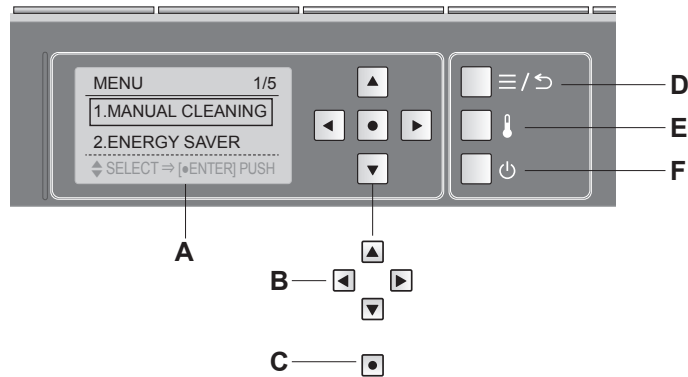

A Display screen

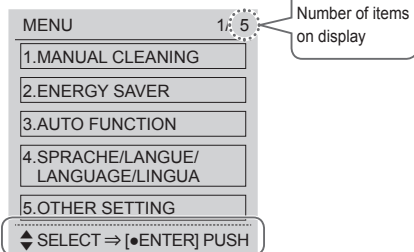

The next step is shown at the bottom of the display screen.

B SELECT keys
Select a setting

C Enter button

D "Menu, Return" button

E "Temperature adjustment" button
Adjust temperatures. (→Pages22, 23)

F "Power ON/OFF" button
Pressing it about 3 seconds or longer turns the power on/off.

1. Press the "Menu, Return" button.

Press the "Menu, Return" button.
▶ The display screen changes.

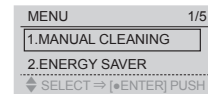

2. Set the item from the display screen.

- When you press the buttons (Up/Down), the frame of the item moves.
- When you press the buttons (Right/Left), you can select the setting.
- When you press the button, the item is entered.

You can set as desired

If you want to return to the previous item, press the "Menu, Return" button.

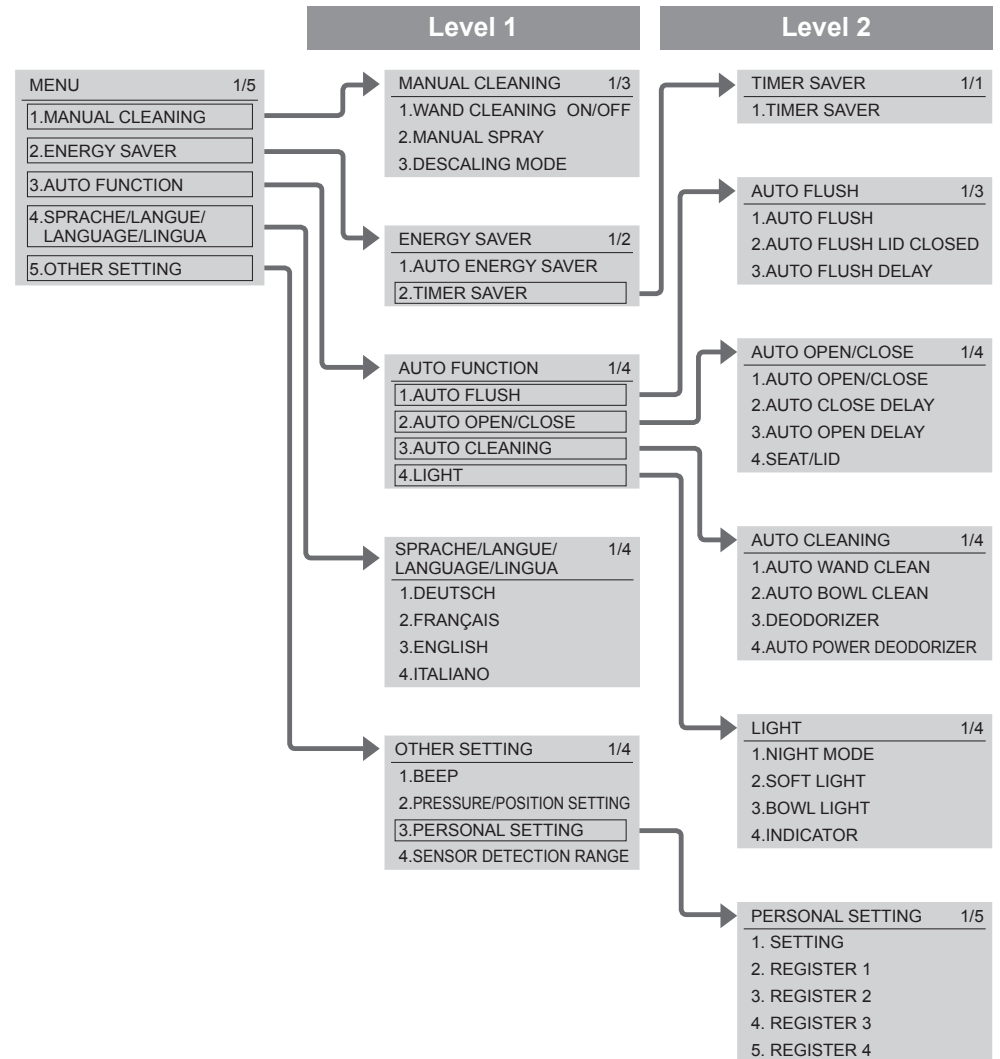

Temperature Adjustment

Warm Water, Toilet Seat, Drying

Five different temperature levels from high to low and "OFF" can be set.

Remote control back side

How to remove the remote control (→Page 12)

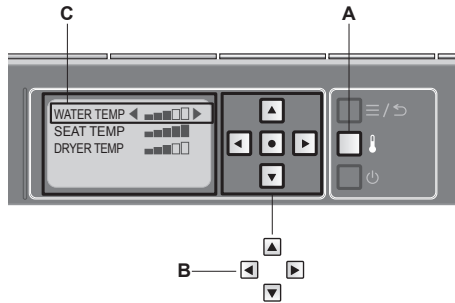

- A "Temperature adjustment" button
- B SELECT keys
Select a setting
- C Displays the temperature level

Note: During setting, the display goes out when no button is pressed within about 60 seconds.

If you fail to complete the setting, redo from the step 1.

Warm water temperature

1. Press the "Temperature adjustment" button.

2. Use the "SELECT keys" to select [WATER TEMP].

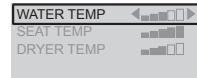

3. Use the "SELECT keys" to select the temperature level.

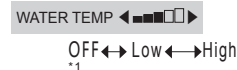

Note: If you want to turn it OFF, press the SELECT key until [OFF] appears

Settings complete

Toilet seat temperature

1. Press the "Temperature adjustment" button.

2. Use the "SELECT keys" to select [SEAT TEMP].

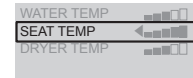

3. Use the SELECT keys to select the temperature level.



Note: If you want to turn it OFF, press the SELECT key until [OFF] appears.
When seat temperature is OFF, the seat LED is unilluminated.

Settings complete

If adjusting the temperature does not warm up the toilet seat.

► Is the energy saver set to "ON"? (→Page26)

Drying air temperature

1. Press the "Temperature adjustment" button.

2. Use the SELECT keys to select [DRYER TEMP].

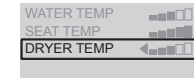

3. Use the SELECT keys to select the temperature level.

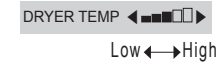

Note: The "Drying" cannot be turned "OFF".

Settings complete

*1 To prevent condensation, the water temperature does not drop below 20 °C even when set to "OFF".

Changing Settings

Setting List

Setting Types	Available Settings Bold: Initial settings
Auto energy saver (→Page 28)	ON/OFF
Auto energy saver+ (→Page 28)	ON/OFF
Timer energy saver (→Page 29)	6H/9H/OFF
Auto flushing (→Page 29)	ON/OFF
Auto flush lid closed (→Page 30)	ON/OFF
Auto flush delay (→Page 30)	SET 1/SET 2/SET 3
Auto open / close (→Page 32)	ON/OFF
Auto close delay (→Page 32)	SET 1/SET 2
Auto open delay (→Page 33)	SET 1/SET 2/SET 3
Seat/lid (→Page 34)	Lid/Seat·Lid
Auto wand CLEAN (→Page 34)	ON/OFF
Auto bowl CLEAN (→Page 35)	ON/OFF
Deodorizer (→Page 36)	ON/OFF
Auto power deodorizer (→Page 36)	ON/OFF
Night light (→Page 37)	ON/STANDBY/TIMER
Soft light (→Page 38)	ON/OFF
Bowl light (→Page 38)	ON/OFF
CLEAN indicator (→Page 39)	ON/OFF
Language settings (→Page 39)	SPRACHE / LANGUE / LANGUAGE / LINGUA
Beep sound (→Page 40)	ON/OFF*1
Pressure/position setting (→Page 40)	ON/OFF
Personal setting (→Page 41)	ON/OFF
Registering Personal Settings (→Page 42)	Register 1/Register 2/Register 3/Register 4
Sensor detection range (→Page 43)	SET 1/SET 2/SET 3/SET 4/SET 5

*1 The beep sounds when settings are being changed, even if the beep noise is turned off. (except for "Pressure/position setting" or "Personal setting")

Setting with buttons on the back of the remote control.

Remote control back side

How to remove the remote control (→Page 12)

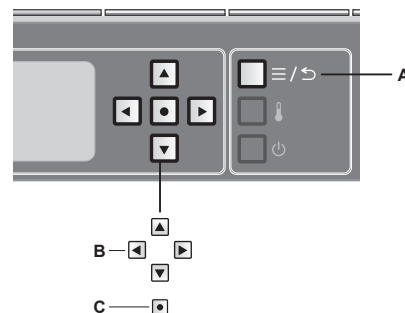

- A "Menu, Return" button
- B SELECT keys
- C Enter button

Note: During setting, the display goes out when no button is pressed within about 60 seconds.
If you fail to complete the setting, redo from the step 1.

Changing Settings

The energy saver features

"Auto energy saver", "Auto energy saver+" or "Timer energy saver" can be selected.

To save energy, the temperature of the toilet seat becomes low (or "OFF").

Note: Even if the energy saver is activated (with the toilet seat heater set to Low or OFF), the toilet seat will be temporarily heated when you sit on it. (To reach the set temperature, the toilet seat takes about 15 minutes.)

The LED indication on the main display returns to the state for when the energy saver is on.

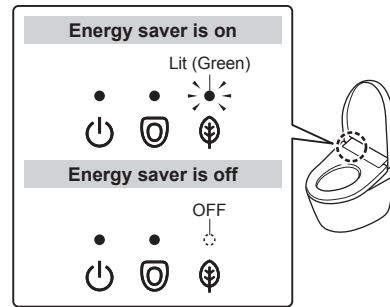

Auto energy saver

You want the product to save energy automatically

The product detects time periods with infrequent use and lowers the toilet seat temperature automatically.

It takes about 10 days for the product to determine the periods when it is used relatively less frequently.

When energy saver is in operation

Main display

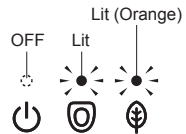

Toilet seat heater



Example

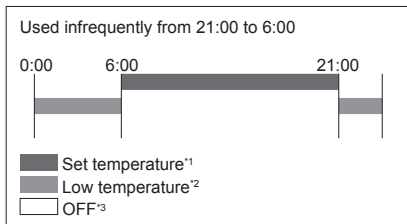

Auto energy saver+

You want to save more energy

In addition to the "Auto energy saver" feature, it automatically turns off the toilet seat heater during time periods when the toilet is not used.

When energy saver is in operation

Main display

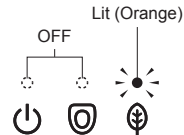

Toilet seat heater

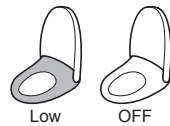

Example

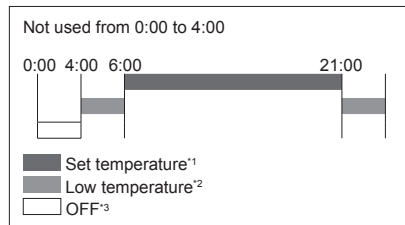

Timer energy saver

You want to save energy only for a preset duration of time. (6 hours, 9 hours)

Once the time is set, the toilet seat heater turns off automatically during the set time period every day.

When energy saver is in operation

Main display

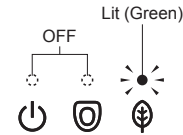

Toilet seat heater



Example

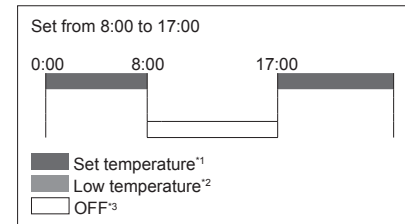

Timer energy saver and Auto energy saver / Auto energy saver+

You want to save the maximum amount of energy possible?

When both "Timer energy saver" and "Auto energy saver / Auto energy saver+" are set, "Auto energy saver / Auto energy saver+" operates when "Timer energy saver" is not operating.

When energy saver is in operation

Main display

During "Auto energy saver / Auto energy saver+":

▶ Same LED indication as "Auto energy saver / Auto energy saver+" (→Page 26)

During "Timer energy saver":

▶ Same LED indication as "Timer energy saver" (→See left)

Toilet seat heater

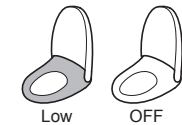

Example

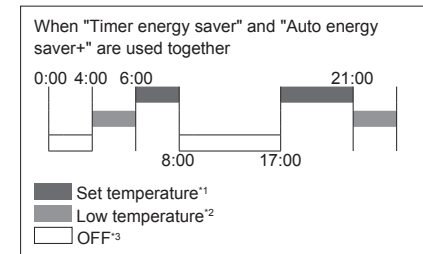

*1 The toilet seat temperature settings on pages 22, 23.

*2 The time period when the toilet seat heater is set to a "Low".

*3 The time period when the toilet seat heater is set to a "OFF"

Changing Settings

How to Set

Auto energy saver

1. Press the "Menu, Return" button.

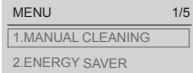

2. Use the "SELECT keys" to select [ENERGY SAVER].

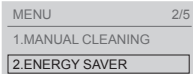

- Press the "Enter" button.

3. Use the "SELECT keys" to select [AUTO ENERGY SAVER].

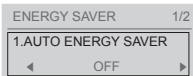

4. Use the "SELECT keys" to select [AUTO ENERGY SAVER+].

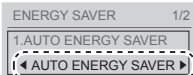

- Press the "Enter" button.

AUTO ENERGY SAVER ON

(To return Press the "Menu, Return" button.)

Auto energy saver+

1. Press the "Menu, Return" button.

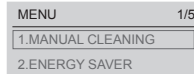

2. Use the "SELECT keys" to select [ENERGY SAVER].

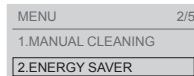

- Press the "Enter" button.

3. Use the "SELECT keys" to select [AUTO ENERGY SAVER].

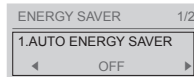

4. Use the "SELECT keys" to select [AUTO ENERGY SAVER+].

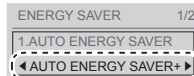

- Press the "Enter" button.

AUTO ENERGY SAVER+ ON

(To return Press the "Menu, Return" button.)

Timer energy saver

Set the "Timer energy saver" at the time you want to start it

1. Press the "Menu, Return" button.

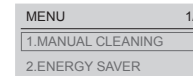

2. Use the "SELECT keys" to select [ENERGY SAVER].

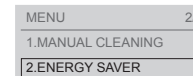

- Press the "Enter" button.

3. Use the "SELECT keys" to select [TIMER SAVER].

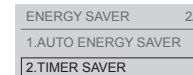

- Press the "Enter" button.

4. Use the "SELECT keys" to select [6H], [9H], or [OFF].

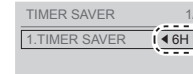

- Press the "Enter" button.

TIMER SAVER ON

(To return Press the "Menu, Return" button.)

To change the timer energy saver time

- ▶ Set the timer energy saver again at the time you want to start it.

Auto flushing

Set whether or not to clean the bowl unit automatically

1. Press the "Menu, Return" button.

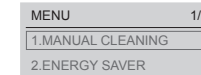

2. Use the "SELECT keys" to select [AUTO FUNCTION].

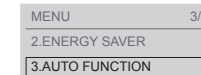

- Press the "Enter" button.

3. Use the "SELECT keys" to select [AUTO FLUSH].

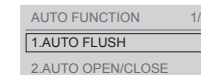

- Press the "Enter" button.

4. Use the "SELECT keys" to select [AUTO FLUSH].

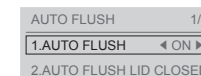

5. Use the "SELECT keys" to select [ON] or [OFF].



- Press the "Enter" button.

AUTO FLUSH OFF

(To return Press the "Menu, Return" button.)

Changing Settings

Auto flush delay*1*2

Change the amount of time before the toilet flushes automatically

1. Press the "Menu, Return" button.

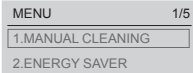

2. Use the "SELECT keys" to select [AUTO FUNCTION].

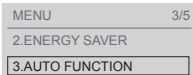

- Press the "Enter" button.

3. Use the "SELECT keys" to select [AUTO FLUSH].

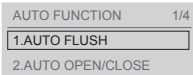

- Press the "Enter" button.

4. Use the "SELECT keys" to select [AUTO FLUSH DELAY].

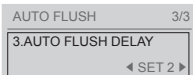

5. Use the SELECT keys to select [SET 1], [SET 2], or [SET 3].



SET 1 (Short) : After about 5 seconds
 SET 2 (Standard): After about 10 seconds
 SET 3 (Long) : After about 15 seconds

If "Auto flush lid closed" is turned ON, the toilet lid closes before flushing the bowl unit as above.

- Press the "Enter" button.

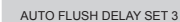

(To return)

Auto flush lid closed

Set whether or not to close the toilet lid automatically before flushing the bowl unit

1. Press the "Menu, Return" button.

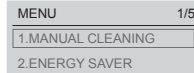

2. Use the "SELECT keys" to select [AUTO FUNCTION].

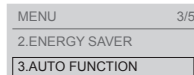

- Press the "Enter" button.

3. Use the "SELECT keys" to select [AUTO FLUSH].



- Press the "Enter" button.

4. Use the "SELECT keys" to select [AUTO FLUSH LID CLOSED].

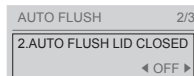

5. Use the "SELECT keys" to select [ON] or [OFF].

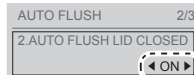

- Press the "Enter" button.

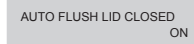

(To return)

About "Auto flush lid closed"...

About 10 seconds after you stand up or move away if you use the toilet in standing position, the toilet lid closes automatically before flushing the bowl unit.

Also, if you press the Flush buttons ("Full flush" or "Light flush") on the remote control, the toilet lid closes before flushing the bowl unit.

Using the toilet seat



Stand up

The toilet lid closes in about 10 seconds.
 ► The toilet lid closes before flushing the bowl unit.

Using the toilet in standing position



Move away

The toilet seat and lid close when you move away.
 ► The toilet seat and lid close before flushing the bowl unit.*3

Using the flush buttons on the remote control



Press



The toilet lid closes.
 ► The toilet lid closes before flushing the bowl unit.

"Auto flush lid closed" does not work if "Auto flushing" and "Auto open / close" are set as below: (Except when using the Flush buttons on the remote control)

	Auto flushing	Auto open / close
1)	OFF	ON
2)	ON	OFF
3)	OFF	OFF

- 1) The toilet lid closes automatically but the bowl unit does not flush.
- 2) The bowl unit flushes automatically but the toilet lid does not close.
- 3) The toilet lid does not open / close and the bowl unit does not flush automatically.

Turn both "Auto flushing" and "Auto open / close" ON. (→Pages 29, 32)

Even if "Auto flushing" is turned ON, "Auto flush lid closed" may not work in some cases. For details, refer to "Auto flush lid closed" does not work" in "Troubleshooting". (→Page 69)

Note: You can change the length of time before water flushes after closing the toilet lid automatically to [SET 1], [SET 2], or [SET 3]. (→Page 30)

If you get up slightly from the seat or sit leftward on the seat while seated on it, the seat sensor may not detect properly, which results in the toilet lid being closed and bowl unit being flushed.

Sit down so that the seat sensor touches your skin directly. (→Page 9)

While using the toilet in standing position, the toilet lid and toilet seat may close and the bowl unit may be flushed. Stand straight in front of the bowl unit.

*1 This operation cannot be performed if "Auto flushing" is turned OFF.

*2 The length of time specified for "Auto close delay (Auto flush lid closed)" if "Auto flush lid closed" is turned ON.

*3 The toilet seat and lid close in about 30 seconds and then the bowl unit flushes.

Changing Settings

Auto open / close

Set whether or not to open and close the toilet lid automatically

1. Press the "Menu, Return" button.

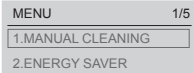

2. Use the "SELECT keys" to select [AUTO FUNCTION].

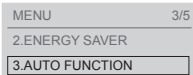

- Press the "Enter" button.

3. Use the "SELECT keys" to select [AUTO OPEN / CLOSE].

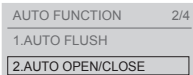

- Press the "Enter" button.

4. Use the "SELECT keys" to select [AUTO OPEN / CLOSE].

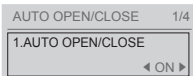

5. Use the "SELECT keys" to select [ON] or [OFF].¹

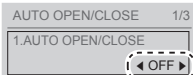

- Press the "Enter" button.

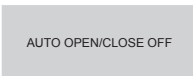

(To return Press the "Menu, Return" button.)

Auto close delay^{2*3}

Change the amount of time before the lid/seat closes automatically

1. Press the "Menu, Return" button.

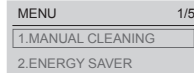

2. Use the "SELECT keys" to select [AUTO FUNCTION].

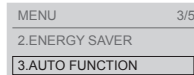

- Press the "Enter" button.

3. Use the "SELECT keys" to select [AUTO OPEN / CLOSE].

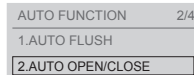

- Press the "Enter" button.

4. Use the "SELECT keys" to select [AUTO CLOSE DELAY].

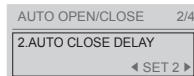

5. Use the "SELECT keys" to select [SET 1] or [SET 2].⁴

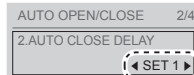

- Press the "Enter" button.

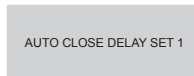

(To return Press the "Menu, Return" button.)

SET 1 (Short) : After about 25 seconds
SET 2 (Standard) : After about 90 seconds

Auto open delay²

Change the time period till automatic opening (After closing by hand or remote control.)

1. Press the "Menu, Return" button.

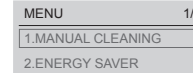

2. Use the "SELECT keys" to select [AUTO FUNCTION].

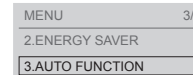

- Press the "Enter" button.

3. Use the "SELECT keys" to select [AUTO OPEN / CLOSE].

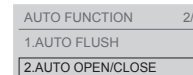

- Press the "Enter" button.

4. Use the "SELECT keys" to select [AUTO OPEN DELAY].

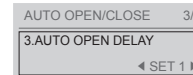

5. Use the "SELECT keys" to select [SET 1], [SET 2] or [SET 3].

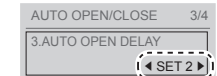

SET 1 (Standard) : After about 15 seconds
SET 2 (Middle) : After about 30 seconds
SET 3 (Long) : After about 90 seconds

- Press the "Enter" button.

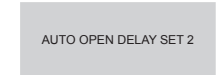

(To return Press the "Menu, Return" button.)

¹ When the "Auto open/close" is set to "OFF", Photocatalyst cleaning does not work while the lid is open.

Please close the lid with your hands or remote control. (Except TCF95180GEU)

² This operation cannot be performed if "Auto open / close" is turned OFF.

³ If "Auto flush lid closed" is turned ON, you cannot use this setting to change the length of time before closing the toilet lid automatically.

Configure the settings for "Auto flush delay". (→Page 30)

⁴ When set to "SET 1 (Short)", the lid/seat does not open automatically for about 15 seconds after closing automatically.

Changing Settings

Seat/lid*1

Set whether or not to open and close only the lid or the toilet seat and toilet lid together

1. Press the "Menu, Return" button.

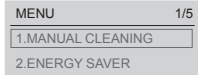

2. Use the "SELECT keys" to select [AUTO FUNCTION].

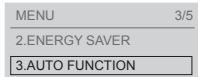

- Press the "Enter" button.

3. Use the "SELECT keys" to select [AUTO OPEN / CLOSE].

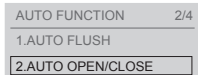

- Press the "Enter" button.

4. Use the "SELECT keys" to select [SEAT / LID].

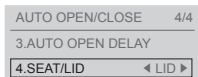

5. Use the "SELECT keys" to select [LID] or [SEAT · LID]*2*3

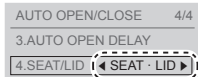

- Press the "Enter" button.

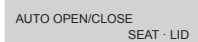

(To return Press the "Menu, Return" button.)

Auto wand CLEAN

Set whether or not to clean the wand automatically

1. Press the "Menu, Return" button.

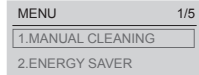

2. Use the "SELECT keys" to select [AUTO FUNCTION].

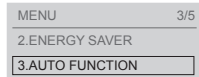

- Press the "Enter" button.

3. Use the "SELECT keys" to select [AUTO CLEANING].

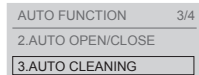

- Press the "Enter" button.

4. Use the "SELECT keys" to select [AUTO WAND CLEAN].

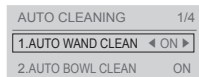

5. Use the "SELECT keys" to select [ON] or [OFF].

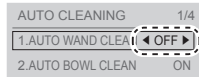

- Press the "Enter" button.

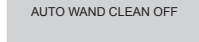

(To return Press the "Menu, Return" button.)

Auto bowl CLEAN

Set whether or not to spray mist in the bowl unit automatically

1. Press the "Menu, Return" button.

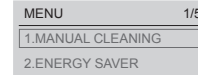

2. Use the "SELECT keys" to select [AUTO FUNCTION].

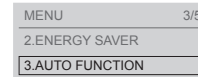

- Press the "Enter" button.

3. Use the "SELECT keys" to select [AUTO CLEANING].

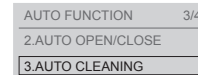

- Press the "Enter" button.

4. Use the "SELECT keys" to select [AUTO BOWL CLEAN].

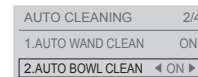

5. Use the "SELECT keys" to select [ON] or [OFF].

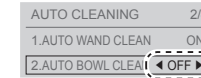

- Press the "Enter" button.

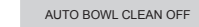

(To return Press the "Menu, Return" button.)

*1 This operation cannot be performed if "Auto open / close" is turned OFF.

*2 When the [SEAT · LID] are set to open automatically, pre-mist is not sprayed.

*3 When [SEAT · LID] are set, a light flush may be performed even if you do not stand and use it, depending on the layout of your toilet.

Changing Settings

Deodorizer

Set whether or not to deodorize automatically after sitting on the toilet seat

1. ≡ / ↵ Press the "Menu, Return" button.

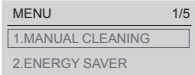

2. Use the "SELECT keys" to select [AUTO FUNCTION].

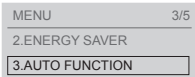

- Press the "Enter" button.

3. Use the "SELECT keys" to select [AUTO CLEANING].

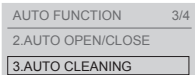

- Press the "Enter" button.

4. Use the "SELECT keys" to select [DEODORIZER].

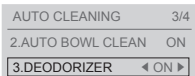

5. Use the "SELECT keys" to select [ON] or [OFF].

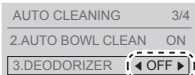

- Press the "Enter" button.

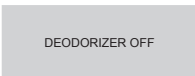

(To return ≡ / ↵)

Auto power deodorizer

Set whether or not to power deodorize automatically after standing up

1. ≡ / ↵ Press the "Menu, Return" button.

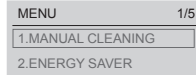

2. Use the "SELECT keys" to select [AUTO FUNCTION].

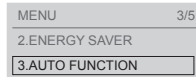

- Press the "Enter" button.

3. Use the "SELECT keys" to select [AUTO CLEANING].

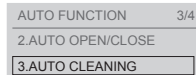

- Press the "Enter" button.

4. Use the "SELECT keys" to select [AUTO POWER DEODORIZER].

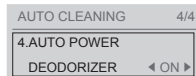

5. Use the "SELECT keys" to select [ON] or [OFF].

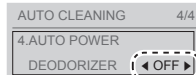

- Press the "Enter" button.



(To return ≡ / ↵)

Night light

Set whether the "Soft light" and "Bowl light" should be operated in a "Night mode" permanently ON, OFF [STANDBY] or in a 12-hour time window [TIMER].

1. ≡ / ↵ Press the "Menu, Return" button.

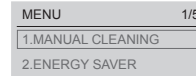

2. Use the "SELECT keys" to select [AUTO FUNCTION].

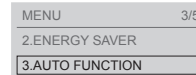

- Press the "Enter" button.

3. Use the "SELECT keys" to select [LIGHT].

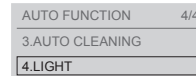

- Press the "Enter" button.

4. Use the "SELECT keys" to select [NIGHT MODE].

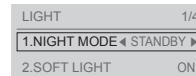

5. Use the "SELECT keys" to select [ON], [STANDBY], or [TIMER].



- Press the "Enter" button.

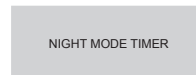

(To return ≡ / ↵)

About "Night light"...

You can change "Soft light" and "Bowl light" to "Night mode", a lighting mode suitable for night.

Note: The light does not turn on if "Soft light" and "Bowl light" are turned OFF.

The "Night light" is turned ON

Soft light
Lights permanently

Bowl light
Lights up only while someone is detected

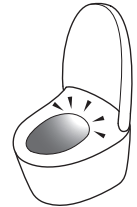

The brightness changes according to human movement.

The "Night light" is turned OFF[STANDBY]

Soft light
Lights up as specified in the settings

Bowl light
Lights up as specified in the settings

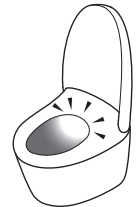

The "Night light" is configured with the timer



The light turns ON / OFF[STANDBY] every 12 hours starting from the set time.

Example

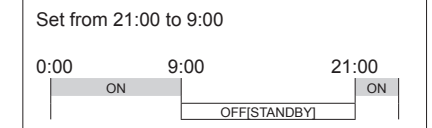

Changing Settings

Soft light

Set whether or not to use the soft light

1. Press the "Menu, Return" button.

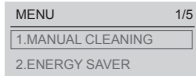

2. Use the "SELECT keys" to select [AUTO FUNCTION].

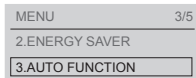

- Press the "Enter" button.

3. Use the "SELECT keys" to select [LIGHT].

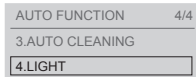

- Press the "Enter" button.

4. Use the "SELECT keys" to select [SOFT LIGHT].



5. Use the "SELECT keys" to select [ON] or [OFF].



- Press the "Enter" button.

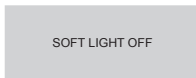

(To return Press the "Menu, Return" button.)

Bowl light

Set whether or not to use the light inside the bowl unit

1. Press the "Menu, Return" button.

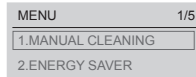

2. Use the "SELECT keys" to select [AUTO FUNCTION].

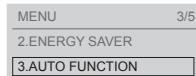

- Press the "Enter" button.

3. Use the "SELECT keys" to select [LIGHT].

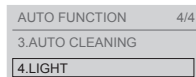

- Press the "Enter" button.

4. Use the "SELECT keys" to select [BOWL LIGHT].



5. Use the "SELECT keys" to select [ON] or [OFF].



- Press the "Enter" button.

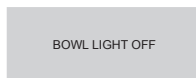

(To return Press the "Menu, Return" button.)

CLEAN indicator

Set whether or not to light up the CLEAN indicator

1. Press the "Menu, Return" button.

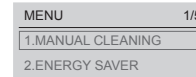

2. Use the "SELECT keys" to select [AUTO FUNCTION].

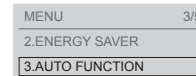

- Press the "Enter" button.

3. Use the "SELECT keys" to select [LIGHT].

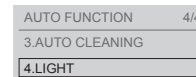

- Press the "Enter" button.

4. Use the "SELECT keys" to select [INDICATOR].

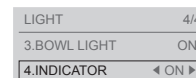

5. Use the "SELECT keys" to select [ON] or [OFF].

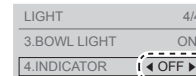

- Press the "Enter" button.

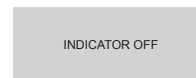

(To return Press the "Menu, Return" button.)

Language settings

Select the language displayed on the back of remote control

1. Press the "Menu, Return" button.

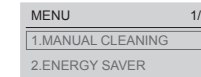

2. Use the "SELECT keys" to select [SPRACHE/LANGUE/LANGUAGE/LINGUA].

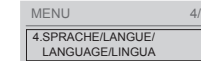

- Press the "Enter" button.

3. Use the "SELECT keys" to select [DEUTSCH], [FRANÇAIS], [ENGLISH], or [ITALIANO].



- Press the "Enter" button.

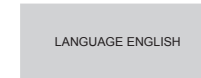

(To return Press the "Menu, Return" button.)

Changing Settings

Beep sound

Set whether or not to make a beep sound

1. Press the "Menu, Return" button.

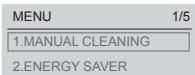

2. Use the "SELECT keys" to select [OTHER SETTING].

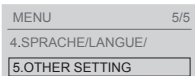

- Press the "Enter" button.

3. Use the "SELECT keys" to select [BEEP].

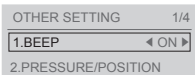

4. Use the "SELECT keys" to select [ON] or [OFF].

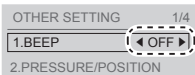

- Press the "Enter" button.

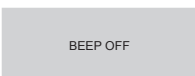

(To return)

Pressure / position setting

Set whether or not to keep your favorite pressure and position settings

1. Press the "Menu, Return" button.

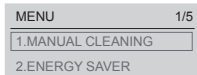

2. Use the "SELECT keys" to select [OTHER SETTING].



- Press the "Enter" button.

3. Use the "SELECT keys" to select [PRESSURE / POSITION SETTING].

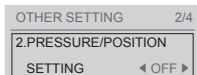

4. Use the "SELECT keys" to select [ON] or [OFF].

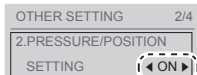

- Press the "Enter" button.



(To return)

Personal setting

Set whether or not to use the personal setting

1. Press the "Menu, Return" button.

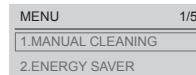

2. Use the "SELECT keys" to select [OTHER SETTING].

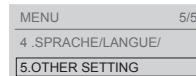

- Press the "Enter" button.

3. Use the "SELECT keys" to select [PERSONAL SETTING].

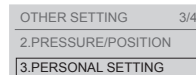

- Press the "Enter" button.

4. Use the "SELECT keys" to select [SETTING].

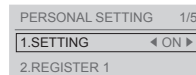

5. Use the "SELECT keys" to select [ON] or [OFF].

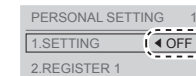

- Press the "Enter" button.

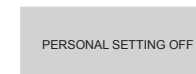

(To return)

Changing Settings

Registering Personal Settings

Register your preferred wand position, etc.

1. Press the "Menu, Return" button.

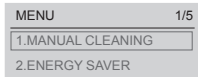

2. Use the "SELECT keys" to select [OTHER SETTING].

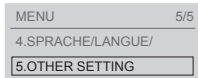

- Press the "Enter" button.

3. Use the "SELECT keys" to select [PERSONAL SETTING].

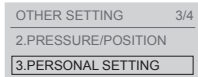

- Press the "Enter" button.

4. Use the SELECT keys to select the desired register number from [REGISTER 1], [REGISTER 2], [REGISTER 3] or [REGISTER 4].

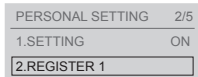

- Press the "Enter" button.

5. Use the "SELECT keys" to select [PRESSURE].

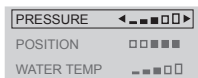

- Use the "SELECT keys" to select the "level".

6. Use the "SELECT keys" to select [POSITION].



- Use the "SELECT keys" to select the "level".

7. Use the "SELECT keys" to select [WATER TEMP].



- Use the "SELECT keys" to select the "level".

8. Press the "Enter" button.

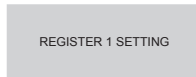

(To return)

Sensor detection range

You can change when to open the toilet lid upon entering the bathroom

1. Press the "Menu, Return" button.

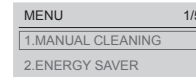

2. Use the "SELECT keys" to select [OTHER SETTING].

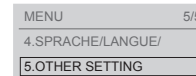

- Press the "Enter" button.

3. Use the "SELECT keys" to select [SENSOR DETECTION RANGE].

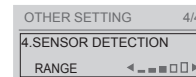

4. Use the "SELECT keys" to select [SET 1], [SET 2], [SET 3], [SET 4] or [SET 5].

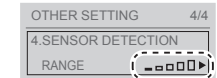

(Example) When to open the toilet lid upon entering the bathroom.



- Press the "Enter" button.

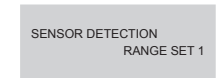

(To return)

Maintenance

Before maintenance

⚠ WARNING

Always turn off the power before maintenance or inspection.

Failure to do so may cause electric shock or malfunction, resulting in a breakdown.

For safety, turn the power OFF before maintenance.*1*2

When the power is turned OFF, the Power LED is unilluminated.

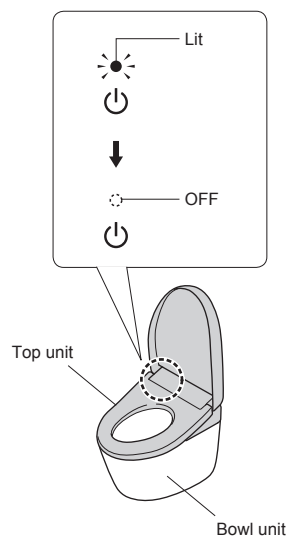

To turn the power "OFF"

Remove the cover on the top of the unit, and flip the power switch to "OFF".

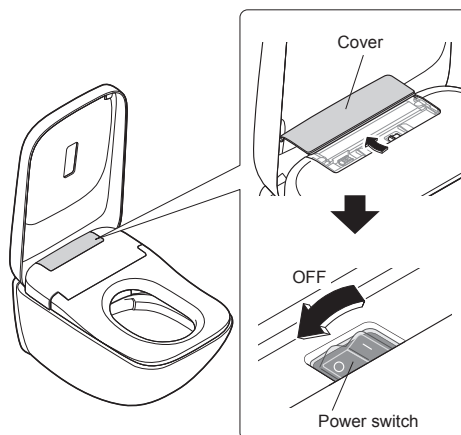

To turn the power "ON"

Flip the power switch to ON.

▶ The "Power" LED illuminates.

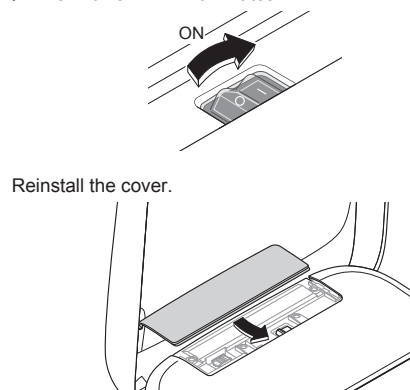

Top Unit

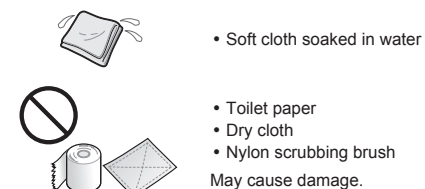

Approximately daily

1. Turn the power "OFF". (→Page 44)

2. Wipe with a soft cloth that has been soaked in water and wrung out thoroughly.

For heavy dirt

Wipe with a soft cloth soaked in diluted, pH neutral kitchen detergent, and then wipe with a soft cloth soaked in water.

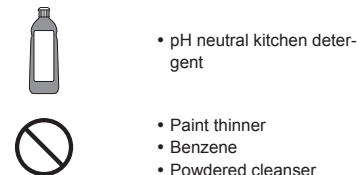

3. Turn the power "ON". (→Page 44)

▶ The "Power" LED illuminates.

Attention

This product is an electric appliance. Be careful not to let water seep inside or leave detergent in the gap between the top unit and bowl unit.

Do not put any cleaning solution directly onto the warm air outlet or cover around the wand, etc.
May damage plastic parts or cause a malfunction.

When using a toilet cleaner to clean the toilet, rinse it off within 3 minutes and leave the toilet seat and toilet lid open.

Wipe off any cleaner that remains on the bowl unit.

If vapor from a toilet cleaner enters the top unit, it may cause a malfunction.

<If "Auto flush lid closed" (→Pages 30, 31) is turned ON> (→Page 8)

Do not press or pull the warm air outlet or cover around the wand with excessive force.

May cause damage or malfunction.

Wipe the back surface of the toilet seat and the toilet seat cushions with a soft cloth tightly wrung out with water.

Otherwise adhesion of dirt may result in discoloration.

Be sure to wipe off any water droplets on the toilet seat.
Failure to do so may cause malfunction of the seat sensor.

*1 Except when using "Wand cleaning", "Descaling mode", "Spray nozzle" or "Manual spray".

*2 The toilet lid does not open automatically for about 20 seconds after the power is turned ON (preparing).

Operate with the remote control.

Maintenance

Bowl Unit



- Cleaning sponge
- Brush
- Neutral toilet detergent



- Strongly acidic cleaners or strong alkaline cleaners
- Cleaners containing abrasive compounds
- Fluoride-based detergent (containing hydrogen fluoride or ammonium fluoride)
- Water-repelling cleaner
- Wire brush
- Abrasive nylon scrubbing brush

Approximately daily

1. Turn the power "OFF". (→Page 44)
2. Clean with a cleaning sponge or brush.
3. Turn the power "ON". (→Page 44)
 - ▶ The "Power" LED illuminates.

If the bowl unit is clogged

Using plunger or similar, provide 10 cm or more clearance between the top of the bowl unit and the water surface. Use commercially available tools that are made for unclogging the bowl unit. (May cause overflow of dirty water and water damage.)

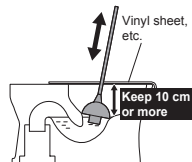

If the floor is dirty

Clean it with a well wrung cloth. (Otherwise, stains or corrosion may occur on the floor.)

Note: Sitting is recommended to reduce splashing caused by standing and urinating.

Attention

Be careful not to expose the top unit or the gap between it and the bowl unit to water.

Otherwise, water may overflow into the room.

Do not use any water repellent, stain-proofing cleaner or surface coating agent.

These products would not damage the porcelain surface, but they may cover the porcelain surface and reduce the effect of the built-in stain prevention technology.

TCF95280GEU

Approximately once a month

To preserve the performance of the photocatalyst cleaning, clean the toilet bowl surface with a toilet brush, etc. using commercially available hydrochloric acid-based or inorganic acid-based detergent.

Manual Spray

EWATER+ mist can be sprayed to separate dirt from the surface for maintenance.

Approximately daily

Remote control back side

How to remove the remote control (→Page 12)

- 1) Press the "Menu, Return" button.
- 2) Use the "SELECT keys" to select [MANUAL CLEANING].
 Press the "Enter" button.
- 3) Use the "SELECT keys" to select [MANUAL SPRAY].
 Press the "Enter" button.

- ▶ EWATER+ mist is sprayed on the bowl unit. Then, perform maintenance on the bowl unit. (→Page 46)

Note: It cannot be used when the wand is out or when you are sitting on the toilet seat.

Maintenance

Wand



- Soft cloth soaked in water

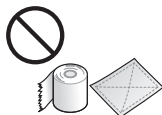

- Toilet paper
 - Dry cloth
 - Nylon scrubbing brush
- May cause damage.

Approximately once a month If you notice dirt (Wand cleaning)

1. Extend the wand.

To operate from the back of remote control

Remote control back side

How to remove the remote control (→Page 12)

- 1) Press the "Menu, Return" button.
- 2) Use the "SELECT keys" to select [MANUAL CLEANING].
 Press the "Enter" button.
- 3) Use the "SELECT keys" to select [WAND CLEANING ON/OFF].
 Press the "Enter" button.

To operate from the front of remote control

Recommended if the remote control is secured to prevent theft, etc.

- 1) Press "Stop" button for about 10 seconds or longer.
- 2) Press "Front washing" button for about 3 seconds or longer.

2. Wipe with a soft cloth that has been soaked in water and wrung out thoroughly.

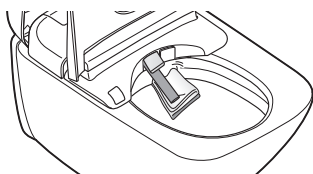

Attention

Do not pull, push or press the wand with excessive force.
May cause damage or malfunction.

3. ■

Press "Stop" button on the front side of the remote control.

- ▶ The wand retracts.
- ▶ Water comes out from around the wand.

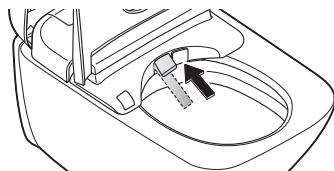

Deodorizing Filter

Approximately once a month

1. Turn the power "OFF". (→Page 44)

2. Hold the tab of the deodorizing filter and pull it out toward you.

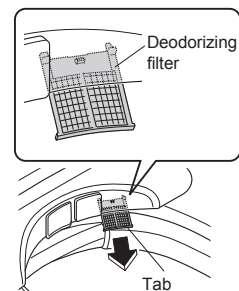

Attention

The deodorizing filter cannot be removed completely.
Do not pull the unit with undue force.
Doing so may cause damage or malfunction.

3. Clean with a tool such as a toothbrush.

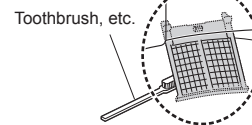

4. Push in the deodorizing filter.

- 1) Push firmly until it is in the original position.

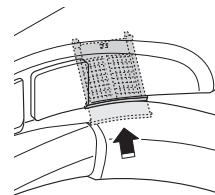

5. Turn the power "ON". (→Page 44)

- ▶ The "Power" LED illuminates.

Maintenance

Descaling

If you think the water pressure has weakened "OR" When "Power" LED (orange) and "Energy saver" LED (orange) flash

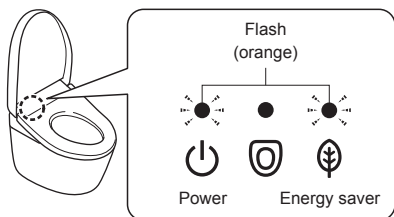

Items to prepare

included item



Beaker



Funnel

Descaling agent



Descaling agent specified by TOTO

or



100% citric acid (for consumption or cleaning)

Request regarding the descaling agent

Please use the descaling agent properly according to the precautions from the manufacturer. Use the descaling agent with the correct dilution. Do not directly insert undiluted descaling agent or powder into the toilet, and make sure the agent is completely dissolved.

Descaling agent specified by TOTO

If you wish to use other agents, please contact us on the phone number on the back of this manual.

Product name	Manufacturer
Sidol® Universal-Entkalker (liquid)	Henkel AG & Co. KGaA
Bref POWER® Universal-Entkalker (liquid)	
Oust® ALL PURPOSE DESCALER (liquid)	

How to dilute

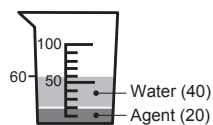

Pour and mix thoroughly

If the beaker is missing

Please use a clean cup and dilute 20 ml of agent with 40 ml of water.

Product name	Manufacturer
swirl® Anti Calc Bio Power Concentrate	Melitta Group
swirl® Anti Calc Bio flüssig	

How to dilute

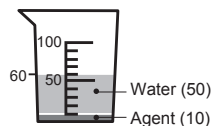

Pour and mix thoroughly

If the beaker is missing

Please use a clean cup and dilute 10 ml of agent with 50 ml of water.

[SIDOL], [Bref POWER] and [OUST] are registered trademarks of [Henkel AG & Co. KGaA].

[swirl] is a trademark of company of the [Melitta Group].

100% citric acid (for consumption or cleaning)

Do not use descaling agents that contain organic acids other than citric acid, surfactants, silicone, or preservatives.

How to dilute

1) Place 60 ml of cold or warm water into the provided beaker.

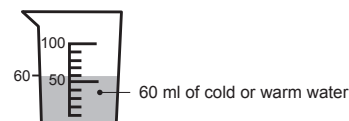

2) Insert the citric acid, and stir well.

If the product indicates how much to use

Follow the instructions on the product.

If the product does not indicate how much to use

Use about one tablespoon (10 to 20 g).



Stir the descaling agent well to ensure that there is no undissolved citric acid or sediment.

If the beaker is missing

Place 60 ml of cold or warm water into a clean cup or similar object, and insert the citric acid (the amount indicated above) to dilute it.

Maintenance

Descaling mode

Note: Washing modes (such as rear and front) cannot be used from step 2 until the second descaling operation in step 11 is complete.

The following functions can be operated with the remote control after the descaling operation in step 11 starts.

- Auto flushing (Full flush, Light flush)

The following functions can be operated with the remote control from approximately 10 minutes after the descaling operation in step 11 starts.

- Opening and closing the toilet lid, Opening and closing the toilet seat

If the work is delayed for more than 30 minutes between steps 2 and 11, the descaling agent will be drained to the toilet with a long beep sound to alert.

If you want to stop the work between steps 2 and 11, flip the power switch to "OFF", and then flip it to "ON". (→Page 44)

Descaling agent will be drained to the toilet with a repeating beep sound to alert. Washing modes (rear, rear soft and front) cannot be used while the long beep sound is alerting.

Attention

To perform descaling:

Completely open the Shutoff valve, without opening and closing it partway. Do not use water in other locations such as the bathroom or kitchen.



Changes to the amount of water supplied may cause the descaling operation to not complete normally.

1. Set descaling mode.

Remote control back side

How to remove the remote control (→Page 12)

- 1)  Press the "Menu, Return" button.

- 2)  Use the "SELECT keys" to select [MANUAL CLEANING].

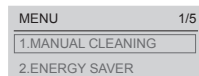

-  Press the "Enter" button.

- 3)  Use the "SELECT keys" to select [DESCALING MODE].

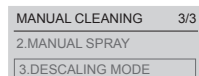
-  Press the "Enter" button.

- ▶ The display changes to [START DESCALING MODE?]



2. Drain water passage.

- 1)  Use the "SELECT keys" to select [YES].



-  Press the "Enter" button.

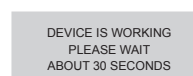

- ▶ Water passage is drained.

(for about 30 seconds)

- You will hear short beep sound.
- Water comes out from around the wand.
- "Power" LED (green) and "Energy saver" LED (green) will flash. (The LEDs will continue to flash until the completion of the entire descaling process.)

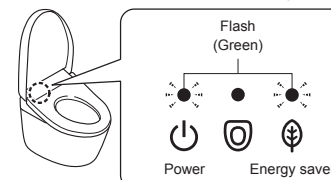

- ▶ When water draining is completed, you will hear a long beep sound.

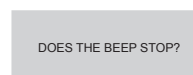

- 2)  When the beep sound stops, press the "Enter" button.

Attention

The "FILL IN THE DESCALING AGENT (1/2)" screen is displayed.

Do not press the "Enter" button until the descaling agent is inserted.

Descaling will not work correctly

Descaling mode (1st time) Steps 3 to 6

3. Dilute agent with water.
(→Please see **How to dilute** on pages 50, 51.)

4. Open the lid and remove cover and cap on the top face of product.

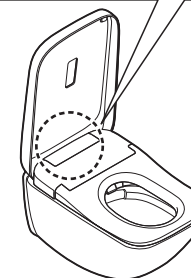
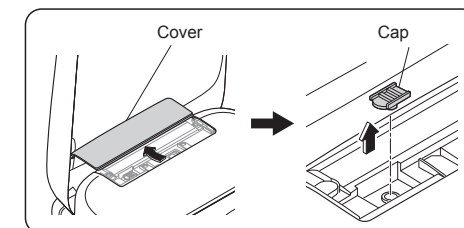
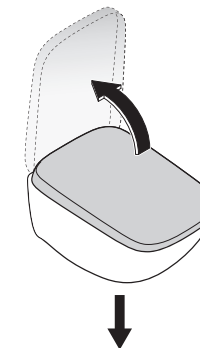

Attention

Please retain cover and cap.

Maintenance

Descaling mode (Continued)

5. Insert funnel and pour diluted agent.

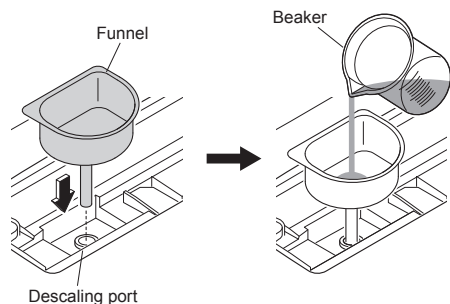

Attention

Please wait until funnel is empty.
Descaling will not work correctly.

If any cleaning agent is spilled on the product, please wipe it off with a soft cloth that has been soaked in water and wrung out thoroughly.
Failure to do so may cause discoloration.

6. Perform descaling.

DESCALING MODE
FILL IN THE
DESCALING AGENT (1/2)

- 1) Press the "Enter" button.

DEVICE IS WORKING
PLEASE WAIT
ABOUT 30 SECONDS

- ▶ Descaling will be performed.
(for about 30 seconds)
 - You will hear short beep sound.
 - Water comes out from around the wand.
- ▶ When water draining is completed, you will hear a long beep sound.

DOES THE BEEP STOP?

- 2) When the beep sound stops, press the "Enter" button.

Attention

The "FILL IN THE DESCALING AGENT (2/2)" screen is displayed.

Do not press the "Enter" button until the descaling agent is inserted.

Descaling will not work correctly

Descaling mode (2nd time) Steps 7 to 11

7. Dilute agent with water.
(→Please see *How to dilute* on pages 50, 51.)

8. Pour diluted agent. (→see step 5 on the left)

9. Remove the funnel and put cap and cover back on.

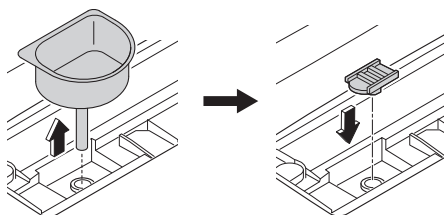

10. Reinstall the cover.

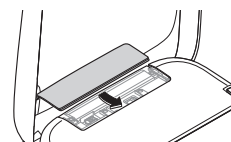

Attention

If any cleaning agent is spilled on the product, please wipe it off with a soft cloth that has been soaked in water and wrung out thoroughly.
Failure to do so may cause discoloration.

11. Perform descaling.

DESCALING MODE
FILL IN THE
DESCALING AGENT (2/2)

- Press the "Enter" button.

DESCALING IN
PROGRESS
PLEASE WAIT FOR
60 MINUTES

- ▶ The "DESCALING MODE" screen in step 1 is displayed again after approximately 30 seconds.
- ▶ Descaling will be performed.
(for about 60 minutes)
 - Water comes out from around the wand at about 20 minute intervals.
 - After about 60 minutes, descaling agent will be drained to the toilet.
 - After draining, you will hear a long beep sound, and the LEDs on product main body stop flashing.

Descaling complete

When the LEDs on the product main body flash for longer than 100 minutes

The descaling operation did not complete normally.
Follow the procedure below to cancel descaling.

Attention

Before canceling descaling, confirm that the drain plug is completely open and that water is not used in other places such as the bathroom or kitchen.

Canceling descaling

- ▶ Flip the power switch to "OFF", and then flip it to "ON". (→Page 44) The descaling agent will be drained to the toilet with a long beep sound to alert. When the operation is complete, the LEDs on the product main body will stop flashing. Repeat the descaling operation from step 1.

If the LEDs continue to flash after canceling descaling

- ▶ Consult with TOTO Service.
(→see contact information on the back cover)

Attention

1. If the spray is still weak after performing Descaling mode:
 - ▶ Clean the Drain plug with water supply filter. (→Page 56)
2. If the spray is still weak after performing 1:
 - ▶ Clean the spray nozzle. (→Page 57)
3. If the problem does not resolve after performing 1 and 2, or if the "Power" LED (orange) and "Energy saver" LED (orange) start to flash after a while:
 - ▶ Perform Descaling mode again. (→Page 52)

Maintenance

Drain Plug with Water Supply Filter

Approximately once every 6 months
If the water pressure is still weak even after performing descaling

1. Close the shutoff valve. (→Page 64)

- ▶ The water supply stops.

CAUTION

Do not remove the drain plug with water supply filter while the shutoff valve is open. Otherwise, water may leak out.

2.

- Press "Wand CLEAN" button.
(Release the pressure from the water supply pipe.)
- ▶ Water comes out from around the wand.

3. Turn the power "OFF". (→Page 44)

4. Open the toilet seat and lid.

5. Open the cover and remove the drain plug with water supply filter.

- 1) Insert a flat-head screwdriver in the hook of the cover to open it.

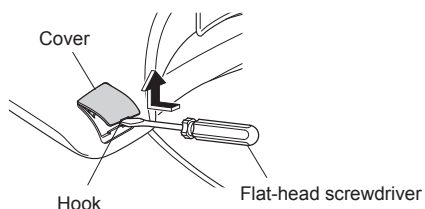

- 2) Loosen the drain plug with water supply filter with a flat-head screwdriver and then pull it.

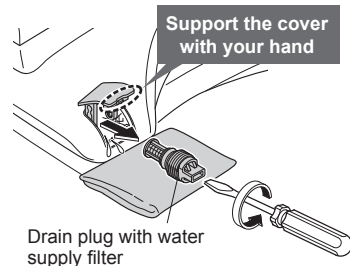

6. Clean the filter with a tool such as a toothbrush.

- ▶ Also, remove any dust from inside the hole of the Drain plug with water supply filter.

7. Reinstall the drain plug with water supply filter and close the cover.

- 1) Insert the drain plug with water supply filter and use a flat-head screwdriver to tighten it securely.

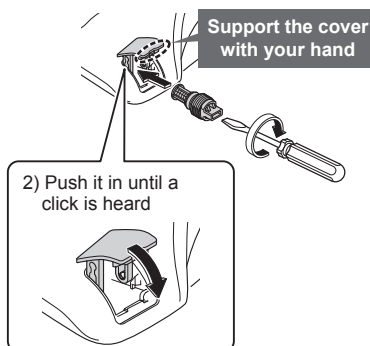

8. Turn the power "ON". (→Page 44)

- ▶ The "Power" LED illuminates.

9. Open the shutoff valve. (→Page 13)

Spray Nozzle

If the water pressure is still weak even after performing descaling and drain plug with water supply filter cleaning

1. Remove the spray nozzle from the wand.

- 1) Extend the wand. (→see step 1 on page 48)
- 2) While holding the wand with a hand, press on both sides of the spray nozzle and slide it.

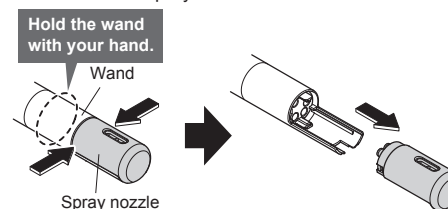

Attention

Do not pull with undue force.
May cause damage or malfunction.

2. Install a spray nozzle (for replacement).

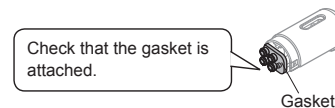

Note: The color and shape of the gasket differ for some products.

- 1) Hold the wand by hand and slide the replacement spray nozzle along the guide and push it in.
- ▶ Install correctly until a click sound is heard.

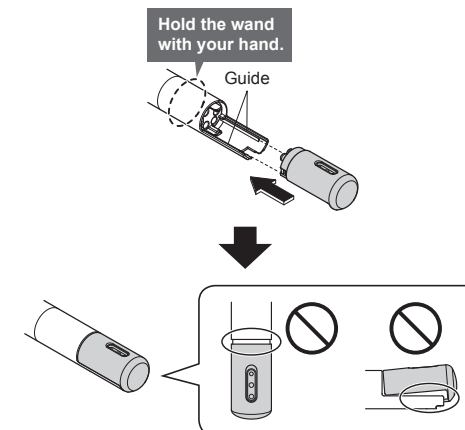

Attention

Do not push with undue force.
May cause damage or malfunction.

- 2)  Press "Stop" button on the front side of the remote control.
- ▶ The wand retracts.
- ▶ Water comes out from around the wand.

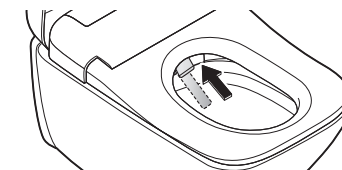

Attention

Keep the spare nozzle in safe place.

Maintenance

Spray Nozzle (Continued)

Cleaning the blocked Nozzle

Perform maintenance on the removed spray nozzle using the descaling agent specified by TOTO or 100% citric acid (for consumption or cleaning).

(→Pages 50, 51)



- Descaling agent specified by TOTO (→Page 50)

or



- 100% citric acid (for consumption or cleaning) (→Page 51)



- Other detergents

Attention

Do not disassemble the spray nozzle.
May cause malfunctions.

What to Do?

If there is no water due to a power outage or water failure

If a power outage occurs

1. Press the button on the flush panel to flush.

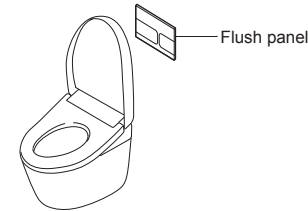

If a water outage occurs

1. Use a bucket to flush the bowl unit. (About 6–8 L)

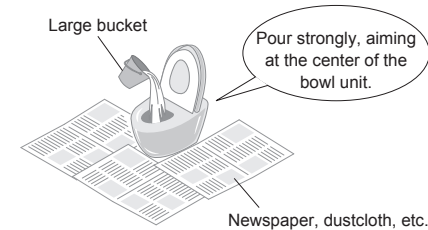

2. If the water level is low after flushing, add more water. (Until the water level does not rise further.)
 - ▶ Prevents odors.

Attention

If there is a water supply failure, set the auto bowl unit cleaning to "OFF". (→Page 29)

When the water supply is restored, make sure to first use water in the bath or kitchen (not with this product) to remove air from the water supply pipes.

Otherwise, air or foreign objects may enter this product, causing failure.

When the water supply is restored, be sure to perform a flush.

To prevent waste from remaining in the drain pipe.

If you cannot operate with the remote control

If the low battery warning LED is flashing, replace the batteries.

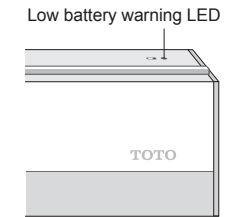

Replacing the batteries

1. Turn the power "OFF". (→Page 14)
2. Remove the remote control from the hanger. (→Page 12)
3. Open the battery cover and replace the two AA batteries. (→Page 12)
 - ▶ The low battery warning LED goes off.
4. Mount the remote control in the hanger. (→Page 12)
5. Turn the power "ON". (→Page 13)
 - ▶ The "Power" LED illuminates.

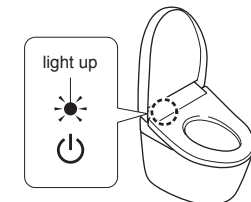

Attention

"ON" and "OFF" settings of the functions such as the energy saver function may be canceled when the batteries are replaced.
Set them again.

What to Do?

Freeze Damage Prevention

When the ambient temperature is likely to drop to 0 °C or lower, take measures to prevent freezing.

Attention

When the ambient temperature is likely to drop to 0 °C or lower, do not use the energy saver feature. May damage the product.

Warm the bathroom or take measures against freezing so that the ambient temperature does not drop below 0 °C.

Before starting to work, set "Auto flushing" (→Page 29) and "Auto open/close" (→Page 32) to "OFF".

1. Close the shutoff valve. (→Page 64)

▶ The water supply stops.

CAUTION

Do not remove the drain plug with water supply filter while the shutoff valve is open. Otherwise, water may leak out.

2. 

Press "Wand CLEAN" button.

▶ Water comes out from around the wand.

Press the "Wand CLEAN" button until water stops coming out from near the nozzle.

(Release the pressure from the water supply pipe and the water from the tank unit.)

3. Turn the power "OFF". (→Page 14)

4. Open the toilet seat and lid.

5. Open the cover and remove the drain plug with water supply filter.

- 1) Insert a flat-head screwdriver in the hook of the cover to open it.

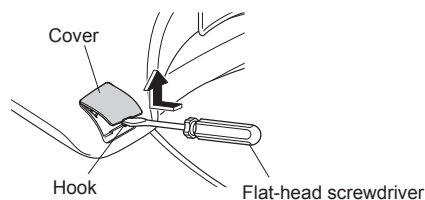

- 2) Loosen the drain plug with water supply filter with a flat-head screwdriver and then pull it.

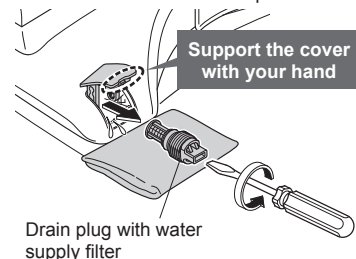

6. When water draining is completed, reinstall the drain plug with water supply filter and cover.

- 1) Insert the drain plug with water supply filter and use a flat-head screwdriver to tighten it securely.

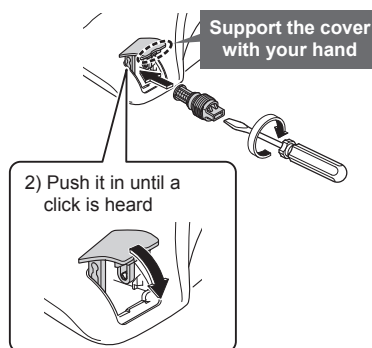

7. Turn the power "ON". (→Page 13)

▶ The "Power" LED illuminates.

8. Set the toilet seat temperature to "High". (→Page 23)

▶ To maintain the temperature, close the toilet seat and toilet lid after finishing work.

To use the product again

▶ The water needs to be resupplied. (→Page 62)

Long Periods of Disuse

If the toilet is in a location you will not visit for a long time, drain the water.

The water in the tank may cause malfunctions or become contaminated and cause skin irritation or other problems.

The water may freeze, causing damage to the product.

Attention

When there is a risk of freezing, take measures to prevent freezing. (→Page 60)

Otherwise, the product may break down.

How to drain the water

1. Close the shutoff valve. (→Page 64)

▶ The water supply stops.

CAUTION

Do not remove the drain plug with water supply filter while the shutoff valve is open. Otherwise, water may leak out.

2. 

Press "Wand CLEAN" button.

▶ Water comes out from around the wand.

Press the "Wand CLEAN" button until water stops coming out from near the nozzle.

(Release the pressure from the water supply pipe and the water from the tank unit.)

3. Turn the power "OFF". (→Page 14)

4. Open the toilet seat and lid.

5. Open the cover and remove the drain plug with water supply filter.

- 1) Insert a flat-head screwdriver in the hook of the cover to open it.

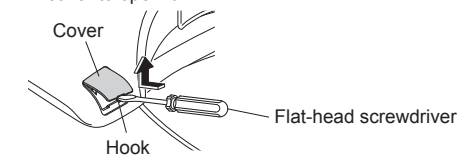

What to Do?

Long Periods of Disuse (Continued)

- 2) Loosen the drain plug with water supply filter with a flat-head screwdriver and then pull it.

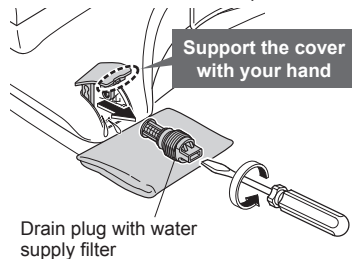

6. When water draining is completed, reinstall the drain plug with water supply filter and cover.

- 1) Insert the drain plug with water supply filter and use a flat-head screwdriver to tighten it securely.

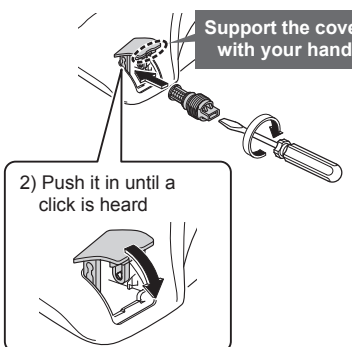

If water may get frozen

- ▶ Add antifreeze solution to the water in the bowl to prevent freezing. The antifreeze solution should not be flushed out. Collect it before using the toilet and dispose of it.

To use the product again

- ▶ The water needs to be resupplied. (→See right)

Resupplying the Water

1. Open the shutoff valve. (→Page 13)
 - ▶ Check that water is not leaking from a pipe or the top unit.
2. If the power is not on, turn the power ON. (→Page 13)
3. Discharge water from the wand.
 - 1) Keep your hand or arm in contact with the seat sensor. (Refer to page 9)
 - 2)  Press "Rear washing" button to discharge water from the wand.
 - ▶ Catch the water in a paper cup or other receptacle.
 - 3) Move your hand or arm from the seat sensor.

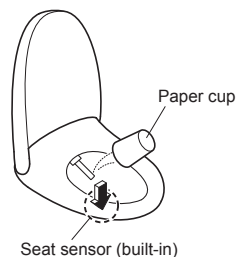

If the remaining water has frozen and no water comes out

- ▶ Heat the inside of the bathroom, and warm the water supply hose and shutoff valve using a cloth soaked in warm water.

How to remove the operation guide

To remove, follow the procedure below.

1. Turn the power "OFF". (→Page 14)
2. Remove the remote control from the hanger. (→Page 12)
3. Remove the hanger and operation guide.

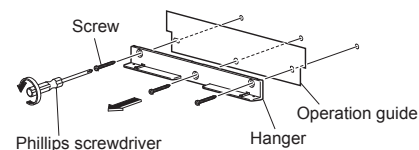

4. Screw the hanger on the wall.

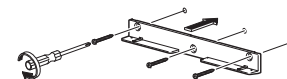

5. Mount the remote control in the hanger.

6. Turn the power "ON". (→Page 13)

- ▶ The "Power" LED illuminates.

To install back the operation guide, follow the procedure above.

- ▶ Install the operation guide at step 4.

Troubleshooting

First, try the actions described on pages 64–73. If the problem persists, consult the installer, seller, or TOTO Service (→see contact information on the back cover).



In the following cases, cut off the power by flipping the power switch to OFF or switching the breaker on the distribution board to OFF, etc., and consult with TOTO Service.

"Power" LED, "Seat" LED, and "Energy saver" LED are flickering

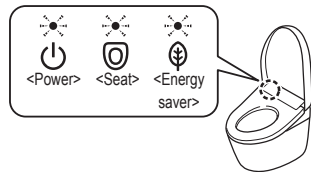

Please check first (A–C)

A: Is the Power LED illuminated?
Is the top unit working?

Is the breaker on the distribution board turned on?

- ▶ Check whether there is a power outage or the breaker has turned "OFF".

Is the power switch flipped to "OFF"?

- ▶ Flip it to "ON". (→Page 13 step 2-2.2)

Is the "Power ON/OFF" setting "OFF"?

- ▶ Switch it to "ON" with the remote control. (→Page 13 step 2-2.2)

B: Is the Energy saver LED lit?

- ▶ While the LED is lit, energy saver (→Page 26) is in operation, so the toilet seat temperature may be reduced or the heater may be turned off.

C: Is the remote control working?

Is the low battery warning LED on the top surface of the remote control flashing?

- ▶ Replace the batteries. (→Pages 12, 59)

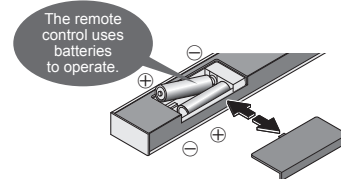

Is there a metal object placed near the top unit or remote control?

- ▶ Move the metal object.

Rear Washing, Front Washing and Wand

Trouble

Please check

The wand (or washing water) does not come out

When the temperature is low, it takes time for the wand to come out after the remote control button is pressed because the water must be warmed up first.

Has the toilet been sat "ON" and used continuously for 2 hours or longer? (If so, operation is stopped for safety purposes.)

- ▶ Stand up from the seat and then use again.

If the water supply pressure drops significantly, for example if water is used elsewhere or if there is a water failure, the function may stop for safety.

- ▶ Turn the power OFF and wait about 10 seconds before turning the power ON again. (→Pages 13, 14)

If the above symptom reappears

There may be a malfunction.

- ▶ Consult with TOTO Service. (→see contact information on the back cover)

When sitting on the toilet seat, is there a toilet seat cover or clothing on the seat sensor? Are you sitting without touching any part of the seat sensor?

- ▶ Check the position of the seat sensor, then sit so your skin is in direct contact with the seat sensor. (→Page 9)

Are you using a toilet seat cover, a toilet lid cover or a seat for infants?

- ▶ Remove any covers. When using a seat for infants or a soft highchair, remove after each use. (→Page 8)



Are you pressing "Wand CLEAN" button?

- ▶ When you press "Wand CLEAN" button, "EWATER+" comes out from the vicinity of the wand to clean the wand.
- ▶ To clean the wand with it extended, perform "Wand cleaning". (→Page 48)

Is descaling being performed?

- ▶ Washing modes (such as rear and front) cannot be used during descaling. (→Pages 52-55)

The wand extends but the washing water does not come out / The washing water pressure is weak

Has a water failure occurred?

- ▶ Press "Stop" button on the remote control and wait until water service is restored.

Is the shutoff valve closed?

- ▶ Fully open the shutoff valve. (→Page 13)

Perform Descaling mode. (→Pages 52-55)

Is the water pressure set to a low level? (→Page 18)

The washing water is cold

Is the warm water temperature set to "OFF" or a low level? (→Page 22)

When the temperature of the water supply or the bathroom is low, the water temperature may be low when first sprayed.

Wash functions stop unintentionally during use

"Rear washing", "Rear soft washing" and "Front washing" stop automatically after 5 minutes of continuous use.

Then the "Power" LED (Green) and the "Energy saver" LED (Green) on the display of the top unit flash about 60 seconds while hot water is prepared.

- ▶ Wait until the LEDs on the display of the top unit light up solidly and then press the button again.

Does the seat sensor have difficulty detecting?

- ▶ If you get up slightly from or sit towards the left of the seat, the seat sensor may temporarily stop detecting your presence. (→Page 9)

Troubleshooting

Rear Washing, Front Washing and Wand (Continued)

Trouble	Please check
Water comes out unexpectedly from the wand	<p>When you sit on the toilet seat, water comes out for several seconds while water is warmed up.</p> <p>Has the CLEAN indicator light up in a cycle? ▶ "Auto wand CLEAN" starts and the wand is cleaned. (→Page 17)</p>

Warm air drying

Trouble	Please check
The dryer temperature is low	Is the dryer temperature set to low level? (→Page 23)
Stops in the middle of use	<p>The feature stops automatically after about 10 minutes of continuous use.</p> <p>Does the seat sensor have difficulty detecting? ▶ If you get up slightly from or sit towards the left of the seat, the seat sensor may temporarily stop detecting your presence. (→Page 9)</p>

Flushing

Trouble	Please check
For not flushing	<p>Are the main tap and the in-wall tank's shutoff valve fully open? (→Page 13)</p> <p>Has a power outage occurred? ▶ Press the button on the flush panel to flush the toilet.(→Page 59)</p> <p>Has a water failure occurred? ▶ Use a bucket to flush water. (→Page 59)</p>
The toilet does not flush even when the button of remote control is pressed	<p>Are you pressing the button repeatedly? ▶ After pressing the flush button, operation will not be accepted for about 10 to 20 seconds.</p> <p>Is descaling being performed? ▶ Flushing may not be performed during descaling, even if the button is pressed. (→Pages 52-55)</p>
The bowl unit does not clean automatically or the timing is delayed (Auto flushing)	<p>Is "Auto flushing" set to "OFF"? ▶ Set to "ON". (→Page 29)</p> <p>Even if "Auto flushing" is set to "ON", it is not available in the following instances.</p> <p>About 60 seconds after the toilet is flushed. ▶ Wait about 60 seconds and flush the toilet with the remote control. (→Page 19)</p> <p>When the time spent sitting on the toilet seat is less than about 6 seconds. ▶ Use the remote control to flush the bowl unit. (→Page 19)</p> <p>When the toilet is used in standing position. ▶ The water flows after a maximum of about 20 seconds from when you leave the bathroom. ▶ If "Auto flush lid closed" is turned ON, 30 seconds after leaving the bathroom, the toilet seat and lid close and then the bowl unit flushes.</p>

The bowl unit does not clean automatically or the timing is delayed (Auto flushing)

During descaling
▶ "Auto flushing" is not performed during descaling. (→Pages 52-55)

When sitting on the toilet seat, is there a toilet seat cover or clothing on the seat sensor?
Are you sitting without touching any part of the seat sensor?
▶ Check the position of the seat sensor, then sit so your skin is in direct contact with the seat sensor. (→Page 9)

The timing for the "Auto flushing" can be changed. (→Page 30)

The toilet flushes on its own

Is "Auto flushing" set to "ON"?
▶ You can turn it "OFF". (→Page 29)

Does the seat sensor have difficulty detecting?
▶ If you get up slightly from or sit towards the left of the seat, the seat sensor may not detect, and thus auto flushing may occur during use. (→Page 9)

A light flush may be performed under the following conditions due to the bathroom layout, etc.

- The toilet seat and lid are open and you stand in front of or walk past the front of the bowl unit.
- "Auto open / close" is set to "Seat-lid". (→Page 34)

Waste material does not flush down completely

Are the main tap and the in-wall tank's shutoff valve fully open? (→Page 13)

Is the water supply to the toilet disrupted by other running water fixtures?
▶ Cease using other fixtures and then flush the toilet.

Are the flush and light flush buttons being used correctly?
▶ Full flush (for solid waste)
▶ Light flush (for liquid waste)

Flushing may be difficult depending the consistency of the waste material.
▶ Flush the toilet again. If the bowl unit is not cleansed with a flushing, remove the stains with a brush or similar instrument. (→Page 46)

A small amount of water flows into the bowl unit after the unit flushes

If the water supply pressure drops significantly, for example if water is used elsewhere or if there is a water failure, water is supplied so that the water surface in the bowl unit rises to a certain level.

If the above symptom reappears
There may be a malfunction.
▶ Consult the installer, seller, or TOTO Service (→see contact information on the back cover).

Some barium remains after flushing

It may be difficult to flush down substances with a higher specific gravity than water, such as barium.
▶ Flush the toilet again. If the bowl unit is not cleansed with a flushing, remove the stains with a brush or similar instrument. (→Page 46)

There is residue on the bowl unit surface

Oil and other hard-to-see grime may stick to the bowl unit surface.
▶ Clean the bowl with (non-abrasive) neutral toilet detergent. (→Page 46)

Troubleshooting

Toilet Seat and Toilet Lid (Auto open/close)

Trouble	Please check
The toilet lid does not open automatically	<p>Is "Auto open/close" set to "OFF"?</p> <ul style="list-style-type: none"> ▶ Set to "ON". (→Page 32) <p>Even when set to "ON", "Auto open/close" is not performed.</p> <ul style="list-style-type: none"> • Approximately 15 seconds since the toilet seat or toilet lid closed automatically • During descaling. (→Pages 52-55) <p>When the toilet lid is closed with the remote control or by hand</p> <p>To make the product more user-friendly, a time interval is set from when the lid is closed to when it will open next.</p> <ul style="list-style-type: none"> ▶ Move away from the toilet and wait at least about 15 seconds before approaching the bowl unit again or open and close by hand. (→Page 19)
	<p>Is "Auto open delay" set to [SET 2] or [SET 3]? (→Page 33)</p>
	<p>The toilet lid does not open automatically for about 20 seconds after the power is turned ON.</p> <ul style="list-style-type: none"> ▶ Use the remote control to open or close it. (→Page 19)
	<p>Is a toilet lid or seat cover installed?</p> <ul style="list-style-type: none"> ▶ Remove any covers. (→Page 8)
	<p>If a function such as "Auto flushing" is operating, the body sensor may not detect properly.</p> <p>You can change the detection range of the body sensor. (→Page 43)</p>
The toilet lid does not close automatically	<p>Is "Auto open/close" set to "OFF"?</p> <ul style="list-style-type: none"> ▶ Set to "ON". (→Page 32) <p>In the following cases, the toilet lid closes in about 5 minutes.</p> <ul style="list-style-type: none"> • When you did not sit on the toilet seat • When you sat on the toilet seat for less than 6 seconds
	<p>Is descaling being performed?</p> <ul style="list-style-type: none"> ▶ "Auto open/close" is not performed during descaling. (→Pages 52-55)
The toilet lid opens on its own	<p>Because the body sensor can detect movement through the wall or door in front of the toilet, the "Auto open/close" function may cause the toilet lid to open automatically even when you are outside of the bathroom.</p> <ul style="list-style-type: none"> ▶ You can also set "Auto open/close" to "OFF". (→Page 32) ▶ You can change the detection range of the body sensor. (→Page 43)
	<p>Is a urinal or wash basin also installed in the bathroom?</p> <ul style="list-style-type: none"> ▶ The body sensor may detect someone using the urinal, causing the toilet lid to open or close.
The toilet lid closes on its own	<p>Is "Auto open/close" set to "ON"?</p> <ul style="list-style-type: none"> ▶ You can turn it "OFF". (→Page 32) <p>Is "Auto close delay" set to [SET 1]? (→Page 32)</p> <p>When sitting on the toilet seat, is there a toilet seat cover or clothing on the seat sensor? Are you sitting without touching any part of the seat sensor?</p> <ul style="list-style-type: none"> ▶ Check the position of the seat sensor, then sit so your skin is in direct contact with the seat sensor. (→Page 9)
The toilet lid and toilet seat open at the same time	<p>Is "Seat/lid" set to "Seat-lid"? (→Page 34)</p>
Stops (or closes) while opening	<p>If the toilet lid or seat hits an obstruction the first time it opens after the power is turned ON, it may stop (or close) partway during the next operation.</p> <ul style="list-style-type: none"> ▶ Eliminate any obstructions and turn the power OFF. Turn the power ON again after about 5 seconds. Then press the "Opening and closing the toilet lid" button on the remote control. (→Pages 13,14,19)

The toilet lid does not close	When the toilet lid closes may differ according to which functions are used.
Cannot open or close with the remote control	<p>If it opens automatically.</p> <ul style="list-style-type: none"> ▶ Check "Is the remote control working?" (→Page 64) <p>If automatic opening does not work either</p> <p>Is descaling being performed?</p> <ul style="list-style-type: none"> ▶ The toilet lid does not open and close during descaling, even if the button is pressed. (→Pages 52-55)

Toilet Seat and Toilet Lid

Trouble	Please check
The toilet seat is cold	<p>Is the toilet seat temperature set to "OFF" or a low level? (→Page 23)</p> <p>Is energy saver in operation?</p> <p>The energy saver feature is on when the "Energy saver" LED is on and the "Power" LED is off on the main display.</p> <p>When you sit on the seat, the toilet seat heater is turned on temporarily and the seat is warmed in about 15 minutes. (→Page 26)</p> <ul style="list-style-type: none"> ▶ You can turn it "OFF" if the energy saver feature is "ON". (→Pages 28, 29) <p>Have you been seated for a long time?</p> <p>After about 20 minutes of sitting, the temperature starts reducing, and after about 1 hour, the toilet seat heater is turned "OFF".</p> <ul style="list-style-type: none"> ▶ Stand up from the seat and then use again. <p>Is a toilet lid or seat cover installed?</p> <ul style="list-style-type: none"> ▶ Remove any covers. (→Page 8)
The toilet seat and lid close on their own and then the bowl unit flushes	<p>Is "Auto flush lid closed" turned ON? (→Page 30)</p>

Auto flush lid closed

Trouble	Please check
"Auto flush lid closed" does not work	<p>Is "Auto flush lid closed" turned OFF?</p> <ul style="list-style-type: none"> ▶ Set to "ON". (→Page 30) <p>If "Auto flush lid closed" is turned ON:</p> <p>Check the "Auto flushing" and "Auto open / close" settings. (→Pages 29, 32)</p> <p>Even if "Auto flushing" is turned ON, "Auto flush lid closed" does not activate in the following cases.</p> <p>For about 60 seconds after the bowl unit flushes.</p> <ul style="list-style-type: none"> ▶ After about 60 seconds have passed, use the remote control to flush the bowl unit. (→Page 19) <p>When the time spent sitting on the toilet seat is less than about 6 seconds.</p> <ul style="list-style-type: none"> ▶ Use the remote control to flush the bowl unit. (→Page 19) <p>When the toilet is used in standing position.</p> <ul style="list-style-type: none"> ▶ About 30 seconds after you leave the bathroom, the toilet seat and lid close and then the bowl unit flushes.

Troubleshooting

Auto flush lid closed (Continued)

Trouble	Please check
The toilet lid closes too early or too late	You can change "Auto flush delay" to modify the length of time before closing the toilet lid. (SET 1 / SET 2 / SET 3) (→Page 30)

Energy Saver

Trouble	Please check
The Energy saver LED does not light up	Has the power to the product been turned "OFF" or was there a power outage? The Energy saver LED on the main display may go off when the power is turned ON even if the energy saver feature is ON. It will turn on within about 24 hours since the setting is retained.
The timer energy saver feature is not working	Have the batteries in the remote control been replaced? "Timer energy saver" may be canceled when the batteries are replaced. ▶ Set the timer energy saver again at the time you want to start it. (→Page 29)
The auto energy saver+ or auto energy saver feature is not working	Because this function takes several days learning the usage conditions before starting energy saver, the amount of energy saving may be low, depending on the frequency of use. ▶ Check the energy saver setting. (→Pages 26, 27)

Deodorizer

Trouble	Please check
The deodorizer seems to be not working	Is "Deodorizer" set to "OFF"? ▶ Set to "ON". (→Page 36) Even after sitting down, you do not hear operation sounds. ▶ Sit down so that the seat sensor touches your skin. (→Page 9) If you hear an operation sound from the deodorizer, but odours are not removed. ▶ Clean the deodorizing filter. (→Page 49)
A strange odour is emitted	Are you using an air freshener or deodorizer that you purchased separately? Doing so may reduce the effectiveness of the product's deodorizer or cause strange odours. ▶ Remove the air freshener or deodorizer.
The auto power deodorizer feature is not working	Is "Auto power deodorizer" set to "OFF"? ▶ Set to "ON". (→Page 36) The auto power deodorizer starts about 10 seconds after you stand up from the toilet seat.

Auto bowl CLEAN

Trouble	Please check
The mist is weak	Perform Descaling mode. (→Pages 52-55)
The mist do not work	Is "Auto bowl CLEAN" set to "OFF"? ▶ Set to "ON". (→Page 35) The following functions do not work when the toilet seat is open. Is "Seat/lid" of "Auto open/close" set to "Seat+lid"? ▶ You can change it to "Lid". (→Page 34) If you use the pre-mist or after-mist immediately after the previous user leaves the bathroom, it may not be activated. Is descaling being performed? (→Pages 52-55) ▶ The pre-mist and after-mist are not sprayed during descaling.
The mist sprays out spontaneously	Because the body sensor can detect movement through the wall or door in front of the toilet, the "Auto bowl CLEAN" function may cause the toilet to pre-mist even when you are outside of the bathroom. ▶ You can switch "Auto bowl CLEAN" to OFF. (→Page 35) If the washing functions (e.g., Rear washing and Front washing) are not used for about 8 hours, "Auto bowl CLEAN" starts and mist is sprayed inside the bowl unit. ▶ You can turn it "OFF". (→Page 73 "The top unit makes a sound", "When not using the product (e.g., at night)")

Light

Trouble	Please check
The soft light, bowl light and CLEAN indicator do not light up	Is the "Soft light", "Bowl light", or "CLEAN indicator" turned OFF? ▶ Set to "ON". (→Pages 38, 39) Is descaling being performed? (→Pages 52-55) ▶ The LEDs inside the bowl unit do not illuminate during descaling.
The soft light lights permanently	Is "Night light" (Night mode) turned ON? ▶ If it is turned ON, the Soft light always turns on. You can also turn it OFF. (→Page 37)
"Night light" (Night mode) is not activated	Have the batteries in the remote control been replaced? "Night light" (Night mode) may be canceled when the batteries are replaced. ▶ Set them again. (→Page 37)
The UV lamp illuminates the inside of the toilet bowl.¹	When "Full flush", "Rear washing", or "Rear soft washing" have not been used in about 10 hours the UV lamp lights up.
The UV lamp does not light up¹	The UV lamp does not light up in the following cases: <ul style="list-style-type: none"> • When the toilet lid is open (when "Auto open/close" is "OFF," etc.) • When "Full flush", "Rear washing", or "Rear soft washing" were not used for solid waste or liquid waste. • During descaling. (→Pages 52-55)

¹ Except TCF95180GEU

Troubleshooting

Others

Trouble	Please check
Water is leaking from the plumbing connections	If any nuts in a connection are loose, firmly tighten them with a tool such as a monkey wrench. ▶ If the water leak does not stop, close the shutoff valve and consult with TOTO Service (→see contact information on the back cover).
The display on the remote control goes out	The display goes out when no button on the remote control is pressed for about 60 seconds or more.
Water splashes up when using the toilet	The water in the bowl unit that is used to mask the smell of excrement is the cause of the splashing. ▶ Adding a layer of toilet paper on the surface of the water can slightly dampen splashing.
When flushing, you hear a squishy sound underneath the floor	There are cases when the sound is made inside the discharge pipe because of the device to ensure water in the bowl unit after the unit flushes.
When flushing, you hear a gurgling sound	When the toilet is flushed together with waste material, the sound is a result of air, waste material and water being pulled through the system.
The top unit makes a sound	<p>When entering the bathroom If "Auto bowl CLEAN" is "ON", you may hear that pre-mist is spraying mist in the bowl unit to make it more difficult for dirt to adhere. ▶ You can turn it "OFF". (→Page 35)</p> <p>When sitting on the toilet seat You may hear the sound of the pump operating to warm the water up.</p> <p>When using the washing functions (Rear washing, Soft rear washing, or Front washing) You can hear the sound of the pump operating while washing water is being supplied. You hear an operation sound at intervals of a few seconds when the washing functions is working properly.</p> <p>When moving away from the bowl unit after use If "Auto wand CLEAN" is "ON" and you use the washing functions (e.g., Rear washing and Front washing), you may hear that the wand is extended and cleaned with "EWATER+". ▶ You can turn it "OFF". (→Page 34)</p> <p>If "Auto bowl CLEAN" is "ON" and you sit on the toilet seat and use the toilet, you may hear that mist of "EWATER+" is sprayed inside the bowl unit. ▶ You can turn it "OFF". (→Page 35)</p> <p>You may hear that the wand is extended and the remaining water in the product is drained when "Auto wand CLEAN" and other functions are performed. You may hear the sound of the remaining water being drained.</p> <p>When "Auto power deodorizer" is "ON", operation sounds are made while the deodorizing power increases for 60 seconds after you stand up from the toilet seat. ▶ You can turn it "OFF". (→Page 36)</p>

The top unit makes a sound

When not using the product (e.g., at night)

When "Auto wand CLEAN" or "Auto bowl CLEAN" is "ON" and the washing functions (e.g., Rear washing and Front washing) are not used for approximately 8 hours, "Auto wand CLEAN" or "Auto bowl CLEAN" will work.

The following sound may be heard at that time.

"Auto wand CLEAN" : Sound of cleaning the wand with "EWATER+"
: Sound of extending the wand and draining remaining water from the product after operation of functions
"Auto bowl CLEAN" : Sound and operating noise of spraying EWATER+ mist on the bowl unit.

▶ You can turn it "OFF". (→see below)

<How to set>

Press both the "Rear washing" button and the "Front washing" button at the same time for at least 10 seconds.

▶ Each time the button is pressed for more than 10 seconds, the "ON/OFF" setting is toggled.

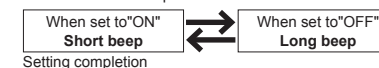

Note: If set to "OFF", the effect of the clean sterilization water may be reduced.

Because the body sensor can detect movement through the wall or door in front of the toilet, the "Auto open/close" and "Auto bowl CLEAN" functions may cause the toilet to pre-mist, or the lid to open, even when you are outside of the bathroom.

▶ You can also set "Auto open/close" or "Auto bowl CLEAN" to "OFF".

(→Pages 32, 35)

▶ You can change the detection range of the body sensor. (→Page 43)

Operating noise may occur for extending the wand to prevent damage due to freezing by discharging the water remaining within the product.

There is a black stain on or around the bowl unit

Ammonia in urine may cause black stains.

▶ If urine has splashed on the bowl unit or floor, wipe it immediately.

There is black or pink slime on the toilet bowl surface

It is a result of growth of airborne fungal spores or bacteria that feed on filth on the toilet bowl.

▶ Clean with (non-abrasive) neutral toilet detergent.

There are water droplets on the bowl unit surface

Condensation occurs when the humidity is high, and there is a significant difference between water and room temperatures.

▶ Wipe off droplets with dry cloth. (May also occur on condensation-proof bowls when the difference between room and water temperatures exceeds 15°C and the ambient humidity reaches 80%.)

The toilet bowl surface repels water or tends to get dirty¹

The toilet bowl surface needs to be cleaned.

▶ Clean with a toilet brush or the like using commercially available hydrochloric acid-based or inorganic acid-based detergent.
For daily cleaning, use neutral detergent.

Is "Auto open/close" set to "OFF"?

▶ If it is set to "OFF", the UV lamp function will not work when the toilet lid is open.

"Power" LED (orange) and "Energy saver" LED (orange) on product main body are flashing

If the "Power" LED (orange) and "Energy saver" LED (orange) flash at the same time, it is time to perform the Descaling mode.

▶ Perform Descaling mode. (→Pages 52-55)

"Power" LED (green) and "Energy saver" LED (green) on product main body are flashing

Is descaling being performed?

▶ The LEDs flash until the descaling operation is complete. (→Pages 52-55)

▶ If the LEDs continue to flash for longer than 100 minutes, the descaling operation has not completed normally. Cancel descaling manually. (→See "When the LEDs on the product main body flash for longer than 100 minutes" on page 55)

If the LEDs continue to flash

▶ Consult with TOTO Service. (→see contact information on the back cover)

¹ Except TCF95180GEU

Specifications

Item	TCF95280GEU	TCF95180GEU
Rated power supply	AC220-240 V, 50 Hz	
Rated power consumption	848-859 W	
Maximum power consumption	1466-1480 W <When the water supply temperature is 0 °C>	
Standby power consumption	≤ 0.5 W	
Frequency band	Body sensor: 24.15-24.25 GHz Remote control: 2405-2480 MHz	
Maximum radio-frequency power	Body sensor: 10.0 dBm Remote control: 1.84 dBm	
Type of water heater	Instantaneous type	
Power cord length	0.5 m	
Water protection level	IPX4	
Bowl unit		
Flush volume	Full flush: 4.5L, Light flush: 3.0L	
Water supply system	Concealed tank system	
Flush type	TORNADO FLUSH	
Bowl style	Elongated	
Top unit		
Washing		
Spray volume ¹	Rear washing: Approx. 0.27-0.43 L/min Rear soft washing: Approx. 0.27-0.43 L/min Front washing: Approx. 0.29-0.43 L/min	
Water temperature	Adjustable temperature range: OFF, about 30-40 °C	
Heater capacity	1200-1428 W	
Safety device	Temperature fuse	
Backflow prevention device	Air gap (according to EN1717), Vacuum breaker	
Heated seat		
Surface temperature	Adjustable temperature range: OFF, about 28-36 °C (Auto energy saver: about 26 °C, Auto energy saver+: OFF)	
Heater capacity	59-70 W	
Safety device	Temperature fuse	
Deodorizer		
Method	O ₂ deodorization	
Airflow volume	Normal mode: Approx. 0.09 m ³ /min Power mode: Approx. 0.16 m ³ /min	
Power consumption	Normal mode: Approx. 1.6 W Power mode: Approx. 4.0 W	
Warm air dryer		
Warm air temperature ²	Adjustable temperature range: about 35-60 °C	
Airflow volume	Approx. 0.25 m ³ /min	
Heater capacity	261-310 W	
Safety device	Temperature fuse	
Water supply pressure	Minimum required water pressure: 0.1 MPa <dynamic>, Maximum water pressure: 1.0 MPa <static>	
Water supply temperature	0-35 °C	
Working ambient temperature	0-40 °C	
Dimensions	W 449 mm x D 675 mm x H 447 mm	
Weight	About 45 kg (Top unit: about 9 kg, bowl unit: about 36 kg)	

Simplified EU Declaration of Conformity

TOTO Europe GmbH hereby declares that this product complies with Directive 2014/53/EU. The full text of the EU declaration of conformity is available at the following Internet address: eu.toto.com

Simplified UK Declaration of Conformity

TOTO Europe GmbH hereby declares that this product complies with the Radio Equipment Regulations 2017. The full text of the UK declaration of conformity is available at the following Internet address: eu.toto.com

This product is available in the following countries.

Germany, United Kingdom, France, Austria, Switzerland, Italy, Netherlands, Belgium, Luxembourg, Denmark, and Ireland.

*1 At 0.20 MPa (dynamic) water pressure

*2 Temperature around the warm air outlet measured by TOTO.

Safety Guidelines

A warm-water cleaning toilet seat is an electric appliance.

Continued use after malfunction occurs or use when its life-time is expired may deteriorate the electric components, producing smoke or resulting in a fire.

For safe use of the warm-water cleaning toilet seat



If any abnormality of the product is observed, stop using it and consult the installer, seller or the contact listed on the back cover of this manual.

(A damaged product may cause a fire, electric shock, or may flood the floors with water.)

•Turn off the power immediately and close the shutoff valve.

Warranty

MANUFACTURER'S GUARANTEE OF TOTO EUROPE GMBH

1. The guarantee of TOTO Europe GmbH

TOTO Europe GmbH (hereinafter referred to as "TOTO") provides a guarantee such that the products it markets shall be free of manufacturing errors in the case of normal use and service for a period of two years from the date of purchase. This guarantee only applies to ultimate consumers.

"Ultimate consumer" within the meaning of this guarantee is any natural person who has entered into a legal transaction for a purpose that can neither be attributable to their commercial nor professional activity and who does not wish to sell the product to other parties.

This guarantee does not affect the ultimate consumer's contractual or statutory rights in dealings with the affected seller and the statutory rights of the ultimate consumer in dealings with the product manufacturer.

Performed repairs that were authorised by TOTO, or any exchange of products or product parts, shall not lead to an extension of the guarantee period and furthermore shall not lead to the guarantee period starting afresh including insofar as these guarantee conditions are included with the substitute product.

2. Guarantee

TOTO provides a guarantee such that the TOTO products are free of manufacturing errors. The assessment whether or not a product is faulty is based on the level of technology at the time of manufacture.

TOTO's obligations in accordance with this guarantee are limited, at TOTO's discretion, to the repair or replacement of products or product parts that are considered faulty by TOTO on condition that such products were installed and used in accordance with the instructions for use issued in conjunction with the product and in compliance with all acknowledged demands placed on professional installation. TOTO reserves the right to conduct such investigations that appear necessary to establish the cause of the fault. TOTO shall not charge the ultimate consumer for the cost of the repair, the products or parts of products as part of repairs covered by the guarantee or products that are replaced under the guarantee.

3. Preconditions to be met to activate the guarantee

The invoice must be made available to TOTO, for example as a copy, stating the date of purchase, the invoice number, name and address of the ultimate consumer as well as the name and address of the seller for a guarantee claim to be valid. TOTO may request that the ultimate consumer provide photographs that either illustrate the damage and/or the type of connections to the power network or to the fresh and industrial water supply lines. Insofar as TOTO requests this, such photographs must also be presented to render the guarantee valid. A claim based on this guarantee takes for granted that the products for which notification of defects has been provided were installed and used properly and in accordance with the

instructions, which TOTO includes in the product delivery, and in this respect the corresponding laws and other legal provisions have been complied with.

If the ultimate consumer claims that the purchased product is faulty, in the event of purchase from an installer, the ultimate consumer is to contact such an installer. In all other cases, the ultimate consumer may contact his/her respective seller or a Service Center authorised by TOTO or contact TOTO itself. Notification of the defect is to be given within a reasonable short period once the defect is identified, at the latest however before the guarantee expires.

4. Guarantee exclusion

This guarantee does not apply to the following points:

- a) Damage or loss as a result of fire, earthquake, flood, storm or other cases of force majeure, emissions, gas damage (hydrogen sulphide), damage caused by salt or abnormal voltage,
- b) Damage or loss as a result of installation not in accordance with the conditions for use or not in accordance with acknowledged demands placed on professional installation; improper, wrong or inappropriate use or failure to follow the TOTO conditions for use or labels on the product or inappropriate product maintenance contrary to the conditions for use,
- c) Damage or loss as a result of altering, dismantling or destroying the product,
- d) Damage or loss as a result of sedimentation or foreign bodies in the water system,
- e) Damage or loss as a result of the water quality in the region in which the product is used,
- f) Damage or loss as a result of relocation following installation or due to a detrimental environment,
- g) Damage or loss caused by circumstances that do not involve the product itself, for example as a result of intervention in the building structure,
- h) Damage or loss caused by bites from animals or insects such as mice or residues of dead animals or insects,
- i) Damage or loss as a result of freezing the product,
- j) Damage or loss as a result of improper energy supply, which in terms of the voltage, frequency or safety fuses does not comply with the regulatory requirements for power supply in a household or electro-magnetic waves that are caused outside the product such as power lines and peripheral devices,
- k) Damage or loss as a result of attaching the product in moving vehicles such as cars and ships,
- l) Damage or loss as a result of using batteries etc.,
- m) Damage or loss as a result of wear-and-tear of items subject to day-to-day servicing (e.g. deodorizing filter, water drain plug),
- n) If spare parts other than original TOTO spare parts are used during repairs or maintenance of the product,
- o) The fault was caused by the transportation or installation of the product,

Warranty

- p) The product is a demonstration product/viewing product/former demonstration product/former viewing product,
- q) If consumables (e.g. filters, filter cartridges or batteries) or materials subject to customary wear-and-tear (such as seals or hoses) are affected,
- r) If the fault was caused by the breakage of brittle parts (e.g. sensor windows or small flaps),
- s) If the fault is attributable to the fact that the product damage was caused intentionally or gross negligently by the ultimate consumer or a third party.

In each individual case, TOTO shall assess whether or not the ultimate consumer has a guarantee claim. If TOTO considers the asserted claim to be justified, and examines the affected product for that reason and thereupon it becomes clear that the product was not faulty or a guarantee claim did not apply, TOTO reserves the right to invoice the ultimate consumer for the costs that arise as a result of a visit by TOTO, or a company commissioned by TOTO, to the ultimate consumer and as a result of the rendered or intended services. If the ultimate consumer can furnish proof that the ultimate consumer could not have been aware that the preconditions for a claim were not met, TOTO shall not invoice the ultimate consumer for its visit to the ultimate consumer and the rendered or intended services. In the event that TOTO does not rectify the defect based on the guarantee, TOTO shall invoice the ultimate consumer for the costs that are actually incurred (material, labour and travelling).

In the event that the ultimate consumer holds the view that he/she has additional claims as a result of other guarantees, the ultimate consumer is to establish the probable validity of its claim and TOTO shall review such claims.

5. Geographical scope of the guarantee

This guarantee is valid exclusively in the European Union, United Kingdom, Switzerland, and Turkey.

If a product is installed in a geographical location in which TOTO neither has a marketing company nor a distribution partner, in respect of reviewing the guarantee activating event the ultimate consumer is to propose an installation company that satisfies comparable quality requirements.

6. Applicable law

This guarantee is subject to the law of the Federal Republic of Germany with the exception of the requirements on application of international private law and the UN Sales Law.

THIS WRITTEN WARRANTY IS THE ONLY WARRANTY MADE BY TOTO.
REPAIR OR REPLACEMENT AS PROVIDED UNDER THIS WARRANTY SHALL BE THE EXCLUSIVE REMEDY AVAILABLE TO THE ULTIMATE CONSUMERS.
TOTO SHALL NOT BE RESPONSIBLE FOR LOSS OF USE OF THE PRODUCT OR FOR OTHER INCIDENTAL, SPECIAL, OR CONSEQUENTIAL DAMAGE OR EXPENSES INCURRED BY PURCHASER, OR FOR LABOR OR OTHER

COSTS DUE TO INSTALLATION OR REMOVAL, OR COSTS OF REPAIRS BY OTHERS, OR FOR ANY OTHER EXPENSE NOT SPECIFICALLY STATED ABOVE.

TOTO Europe GmbH
Zollhof 2 40221 Düsseldorf Germany

Important User Guidance Information



If you want to dispose this product, do not mix it with general household waste.

Dispose of this product properly according to laws and regulations in your country.

Disposed of used batteries properly.
Do not dispose of them together with general household waste.