

Table of Contents

Introduction

Safety Precautions	4
Operational Precautions	10
Parts Names	12
Preparation	14
Using the Product for the First Time.....	14
How to turn off the product	17

Operation

Basic Operations	18
Using the Remote Control	18
Stop	18
Rear cleansing.....	18
Rear soft cleansing	18
Front cleansing	18
Oscillating cleansing	18
Pulsating cleansing.....	18
Wand CLEAN	18
Water pressure adjustment	19
Wand position adjustment.....	19
Personal setting lock.....	19
Mechanism of Auto Functions	20
Deodorizer	20
Pre-mist.....	20
Auto wand CLEAN	20
Temperature Adjustment.....	22
Toilet Seat, Warm Water	22
Changing Settings.....	24
Setting List	24
The energy saver features	26
How to Set.....	28
Auto energy saver.....	28
Auto energy saver+.....	28
Timer energy saver	29
Auto wand CLEAN	30
Pre-mist	30
Deodorizer	31
Auto power deodorizer.....	31
Beep sound	32
Personal setting lock.....	32

Maintenance

Maintenance	33
Before maintenance	33
Power Plug.....	34
Main Unit.....	35
Wand.....	36
Wand cleaning	36
Filter	37
Gap between the Main Unit and Bowl Unit.....	38
Gap between the Main Unit and the Toilet Lid.....	40
Descaling mode.....	41
Water Filter Drain Valve.....	45
Spray Nozzle	46

Reference

What to Do?	48
If the water does not flow due to a water service interruption	48
If you cannot operate with the remote control	48
Replacing the batteries	48
Freeze Damage Prevention	49
Long Periods of Disuse.....	50
How to drain the water.....	50
Resupplying the Water.....	51
Removal of Operation Guide	52
Troubleshooting	53
Please check first	53
Rear Cleansing, Front Cleansing and Wand	54
Toilet Seat and Toilet Lid.....	55
Energy Saver.....	55
Deodorizer.....	56
Pre-mist, Auto wand CLEAN and Wand CLEAN	56
Others	57
Specifications	58
Safety Guidelines	59
Warranty.....	60
Important User Guidance Information.....	62



The available functions vary according to the part no.

Functions	Part No.*1	
	TCF34270GEU	TCF34170GEU TCF34120GEU TCF34120GGB
Deodorizer	●	-
Pre-mist	●	-

*1 The part no. is on the toilet lid label. (→Page 12)

Safety Precautions

These precautions are important for safe usage. Be sure to follow them and use the product correctly. The following symbols are used to indicate important safety instructions for the use of the product.

Symbol	Meaning
 WARNING	May result in death or serious injury.
 CAUTION	May result in injury or property damage.

WARNING

**TCF34270GEU, TCF34170GEU
TCF34120GEU, TCF34120GGB**

Never disassemble, repair or alter.

Doing so may cause fire, electrical shock, overheating, short circuit or breakdown.

Do not use the product if a malfunction occurs.

In case of breakdown or other problems, be sure to cut off power, by flipping the power switch to OFF (TCF34270GEU, TCF34170GEU) or switching the breaker on the distribution board to OFF, etc.

Close the water shutoff valve to stop water supply.

Possible malfunctions:

- Water is leaking from a pipe or the main unit.
- The product is cracked or broken.
- The product makes a strange noise or emits a strange odor.
- The product emits smoke.
- The product is abnormally hot.
- The toilet seat cushion is out of place.

Continued use after malfunction could cause a fire, electric shock, heat, short circuit, injury or water damage.

Do not use other water than allowed by the laws and ordinances of the region of use. Only Use potable water.

Do not use seawater or recycled water.

Doing so may cause irritation to the skin and malfunction.

Keep cigarettes and other open flames away from the product.

Failure to do so may cause fire.

Refrain from sitting on the seat for long periods.

It may cause low-temperature burns.

To prevent the following persons from getting a moderate temperature burn during use, other person should turn off the toilet seat heater.

- Young children, the aged and other users unable to set the temperature appropriately themselves.
- The ill, physically disabled and others who do not have freedom of movement.
- Those using any medicines that cause drowsiness (sleeping or cold medicine), those who have been drinking heavily, anyone severely fatigued and anyone else liable to fall asleep.

Do not cut the string that connects the main unit and base plate.

Doing so may cause fire, electrical shock, overheating, short circuit or breakdown.

If the power cord is damaged, avoid danger by having the manufacturer's repair department or equivalent specialist replace it.

Turn the power OFF before maintenance or inspection.*1

Failure to do so may cause electrical shock or malfunction.

*1 How to turn off the product (→Page 17)

WARNING

Turn the power OFF before removing the main unit.*1

Failure to do so may cause fire or electrical shock.

When leaking battery fluid adheres to your body or clothes, wash it away with clean water.

The fluid may damage your eyes or skin.

Do not install the product on moving vehicles such as wheeled vehicles or boats.

Doing so may cause fire, electric shock, short circuit or malfunction.

The toilet seat, toilet lid, main unit, or other parts may come loose and fall off, resulting in injury.

Do not use any power supply other than the one specified.

AC 220–240 V, 50 Hz

Doing so may cause fire or excessive heat.

This is an electrical product. Do not install it anywhere water is likely to get on the product or anywhere with humidity high enough that water is likely to form on the surface of this product. When using the product in a bathroom, install a fan or ventilation port and ensure good air flow through the bathroom.

Failure to do so may cause fire or electrical shock.

Always connect the product to the cold water supply.

Connecting to hot water supply may result in burns and equipment damage.

Preliminary studies in females suggest that overuse of continuous spraying can increase the possibility of vaginal mucosa drying and potential reduction in desirable microbial organisms. Although these studies have not been validated, please consult your healthcare provider for concerns regarding whether these circumstances may apply to you.

More importantly, if you are an individual suffering from any immune deficiency as a result of disease, chemotherapy, or other medical condition compromising the immune system you should consult your healthcare provider before use of this product.

TCF34120GEU, TCF34120GGB*2

Do not touch the connection of power cord with wet hands.

Doing so may cause electrical shock.

Do not get any water or cleaning solution on the main unit or power source connection.

Doing so may cause fire, electrical shock, heat or short circuit.

Doing so may cause the product to crack resulting in injury or water damage.

Do not touch the power source connection during thunderstorms.

Doing so may cause electrical shock.

Do not allow the water supply hose to touch the power source connection.

Doing so may cause condensation resulting in a fire, electrical shock, heat or a short.

Do not do anything that may damage the power cord or power source connection.

Do not strike, yank, twist, excessively bend, damage, alter, or heat the power cords.

Also, do not place anything heavy on, bind or pinch the power cords.

Using a damaged power cord may result in a fire, electrical shock, heat or short.

Confirm that a properly grounded outlet (TCF34120GEU) or terminal block (TCF34120GGB) has been installed.

Failure to install a grounded outlet or terminal block could cause electrical shock in the event of a malfunction.

*If there is no ground installed, ask the contractor who did the installation to install the ground.

*2 Customers do not handle the power source connection for TCF34270GEU and TCF34170GEU.

Safety Precautions

WARNING

Confirm that the outlet for electrical power (TCF34120GEU) or terminal block (TCF34120GGB) is as described below.

Failure to do so may cause fire or electrical shock.

- a. Apply a current to the outlet (TCF34120GEU) or terminal block (TCF34120GGB) through a differential residual current device whose release current does not exceed 30 mA.
- b. Confirm that the outlet (TCF34120GEU) or terminal block (TCF34120GGB) and its wiring plug at least 0.60 m away from the outside of the shower or bath tub.

*Confirm that the wiring in a. and b. above is complete. If the wiring has not been completed, ask the contractor who did the installation to do it.

TCF34120GEU

Do not use a loose or faulty electrical outlet.

Doing so may cause fire or short circuit.

Do not use any outlet beyond its specified rating.

Plugging too many plugs into the same outlet, for example using outlet splitters, can cause fire due to heat.

Insert the power plug securely into the outlet.

Failure to do so may cause fire, heat or short circuit.

To unplug, hold the power plug, not the power cord.

Do not unplug by pulling the power cord.

Pulling on the power cord may cause damage and result in fire or heat.

CAUTION

**TCF34270GEU, TCF34170GEU
TCF34120GEU, TCF34120GGB**

Do not use the product if the main unit is unstable.

Doing so may cause the main unit to come loose and fall, resulting in injury.

(If there is backlash in the main unit, consult the installer, seller, or TOTO Service. See contact information on the back cover.)

If the product is damaged, do not touch the damaged section.

Doing so may cause electrical shock or injury.
Replace it immediately.

Do not apply strong force, mechanical shock, step on or stand on the toilet seat, toilet lid or main unit. Also do not place any heavy object on the toilet seat, toilet lid or main unit.

Doing so may cause cracking or cause the main unit to come loose and fall, resulting in injury.

Doing so may damage the product and cause injury or water damage.

Do not lift up this product by the toilet seat or lid.

Do not raise the toilet seat or lid while objects are resting on top of the unit.

Doing so may cause the main unit to come loose and fall, resulting in injury.

When maintaining the plastic parts (main unit etc.) or the water supply hose, use a pH neutral kitchen detergent diluted with water. Do not use any of the following.

Toilet cleaner, household cleaner, benzene, paint thinner, powdered cleanser or nylon scrubbing brush.

These items may damage or crack the plastic and cause injury or malfunction.

These items could damage the water supply hose and cause a water leak.

To prevent a sudden water leak, do not remove the water filter drain valve when the shutoff valve is open.

Doing so will cause water to spurt out.

(→Refer to Page 45 for instructions on cleaning the water filter drain valve.)

Do not fold or crush the water supply hose; do not damage by cutting with a sharp object.

Doing so may cause water leaks.

Do not install the base plate, which is not attached.

Doing so may cause damage.

If a water leak should occur, always close the shutoff valve.

When the ambient temperature is likely to drop to 0 °C or lower, prevent damage to the pipes and hoses due to freezing.

Frozen water pipes could cause the main unit and the pipes to break, resulting in a water leak.

Regulate the room temperature to prevent the pipes and hoses from freezing during cold months.

Drain the water.

When not using the product for a long time, close the shutoff valve, drain the water from the main unit and water supply hose, and then turn the power OFF.*1

When using the product again, allow the product to refill with water first. Otherwise, the water in the tank might become contaminated and cause skin inflammation or other problems. (→Refer to Page 51 for instructions on replenishing the water.)

Leaving the power on may cause fire or heat.

When installing the water filter drain valve, make sure that it is securely tightened in its proper position.

Failure to securely tighten it may cause a water leak.

*1 How to turn off the product (→Page 17)

Safety Precautions



If the bowl is clogged, turn the power OFF*¹ and remove the clog.

Use commercially available tools that are made for unclogging the bowl unit to remove the clogging.

Push the main unit securely on to the base plate.

After pushing the main unit until a click sound is heard, pull it slightly toward you to make sure that the product does not detach.

Failure to do so could cause the main unit to come loose resulting in injury.

Make sure of the plus and minus signs on the batteries before inserting them.

Remove depleted batteries immediately.

When replacing the batteries:

- Replace both batteries with new ones.
- Use the same brand for both new batteries (any brand available).

Failure to do so may cause the batteries to leak fluid, generate heat, rupture, or ignite.

When the product is supposed not to be used for long time, remove the batteries from the remote control.

Failure to do so may cause the batteries to leak fluid.

*1 How to turn off the product (→Page 17)

This product is classified as Class I Equipment and must be grounded.

Install this equipment so that its power breaker is accessible.

Use the new hose set included with this equipment. Do not reuse an old hose set.

This appliance is not intended for use by persons (including children) with reduced physical, sensory or mental capabilities, or lack of experience and knowledge, unless they have been given supervision or instruction concerning use of the appliance by a person responsible for their safety. Children should be supervised to ensure that they do not play with the appliance.

Operational Precautions

For prevention of malfunctions

Do not block the remote control transmitter or receiver.

For prevention of damage

Wipe plastic areas such as the main unit and remote control with a soft cloth tightly wrung out with water.

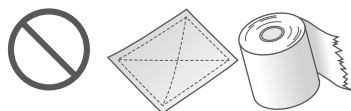

Dry cloth or tissue

Do not lean against the toilet lid.



For prevention of malfunctions and failures

Turn the power OFF if there is a risk of lightning strike.*1

A toilet seat cover or a toilet lid cover cannot be used.

The seat switch may not function properly.

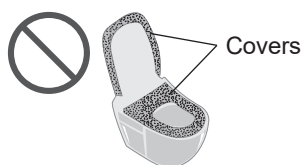

Do not urinate on the main unit, toilet seat or wand.

Doing so may cause a failure or discoloration.

Do not apply strong forces to the control panel of the remote control.

When using a toilet cleaner to clean the toilet, rinse it off within 3 minutes and leave the toilet seat and toilet lid open.

If vapor from a toilet cleaner enters the main unit, it may cause a malfunction.

► Wipe off any cleaner that remains on the bowl unit.

Do not use the product with the toilet lid removed.

Do not expose to direct sunlight.

Doing so may cause changes in color, irregular heated seat temperature or remote control malfunction.

It may also cause product malfunction due to the change in temperature.

Use radios, etc. away from the product.

The product could cause interference with the radio signal.

If you use a booster seat for infants or a soft highchair, remove it after use.

Keeping it installed may prevent some of the functions from being used.

Do not apply force to the remote control.

This cause malfunction.

► To prevent the remote control from being dropped, set it in the hanger when you are not using it.

Be careful not to expose it to water.

Do not place anything on the toilet seat and lid, and do not press them with hands.

Failure to do so may turn on the seat switch, causing the floor to get wet if buttons on the remote control are touched and warm water comes out from the wand.

*1 How to turn off the product (→Page 17)

About the seat switch

When you sit on the toilet seat, the seat switch turns ON, enabling you to use various features.

A click sound is heard when the seat switch is ACTIVATED.

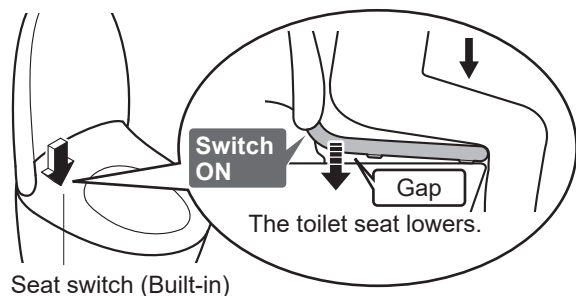

Sit back on the toilet seat.

The seat switch will not turn on unless you sit on the seat properly.



Note: When a child uses the product, the seat switch may not be ACTIVATED by their light body weight.

Since the toilet seat is designed to move up and down, a clearance is provided between the toilet seat cushion and the bowl unit.

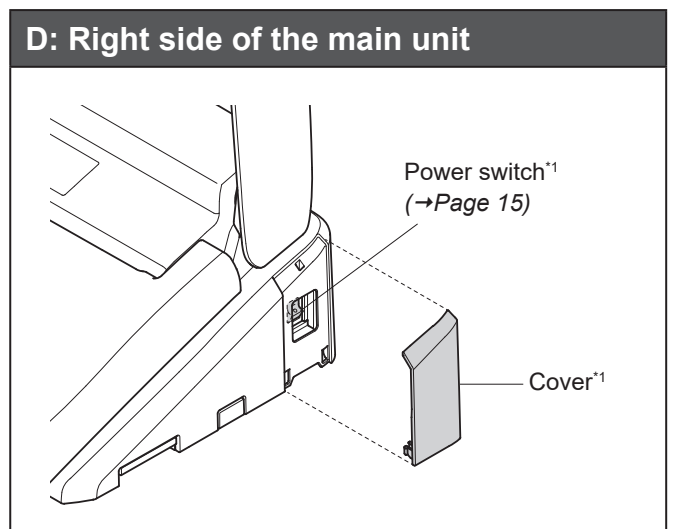
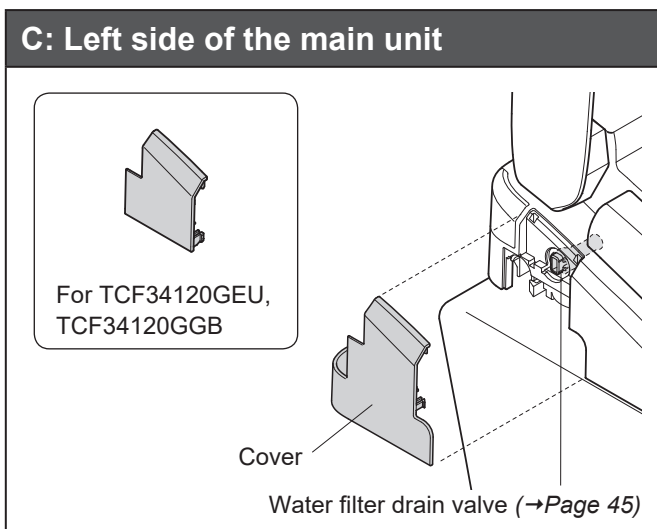
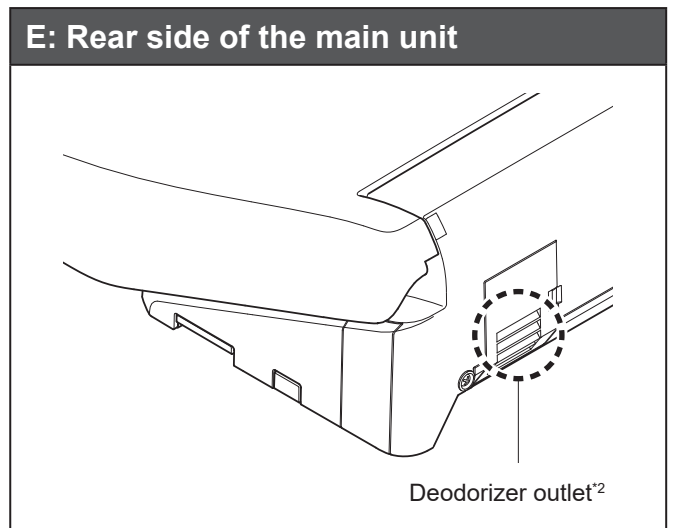
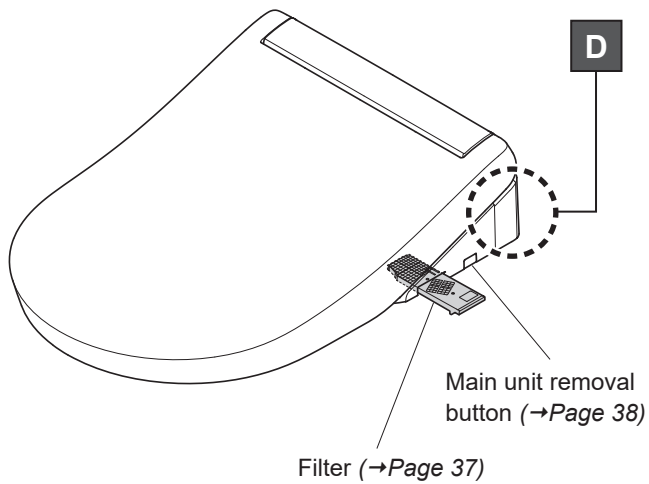
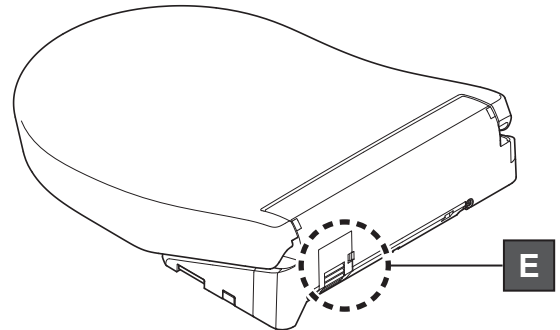
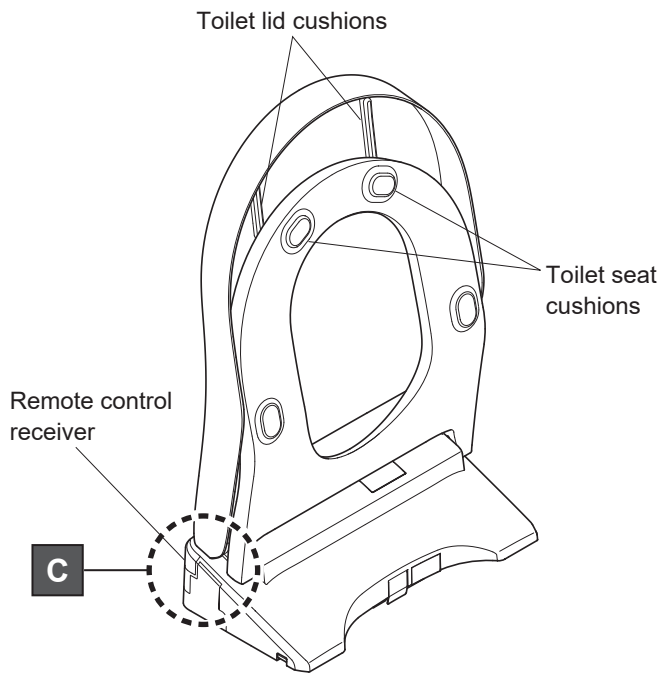

Descriptions in this manual are based on the illustration of TCF34270GEU.

Preparation

Using the Product for the First Time

1. Insert the battery

1.1 Remove the remote control from the hanger.

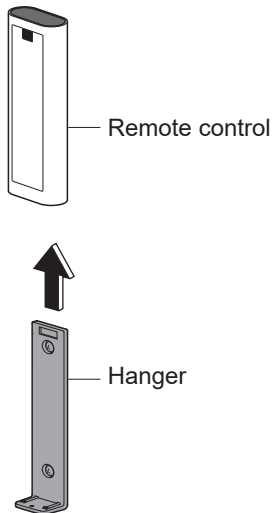

1.2 Open the battery cover and insert two AA batteries.

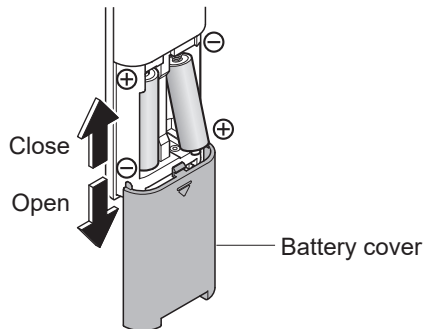

- ▶ When batteries are properly loaded, all the LEDs on the remote controll light up for about 2 sec.

1.3 Mount the remote control in the hanger.

About the batteries

Use dry cell, alkaline batteries.

Be sure to follow "Safety Precautions" to prevent the batteries from rupturing or leaking fluid. (→Pages 5, 8)

If the remote control is secured to prevent theft

- 1) Remove the screw from the remote control fixture.

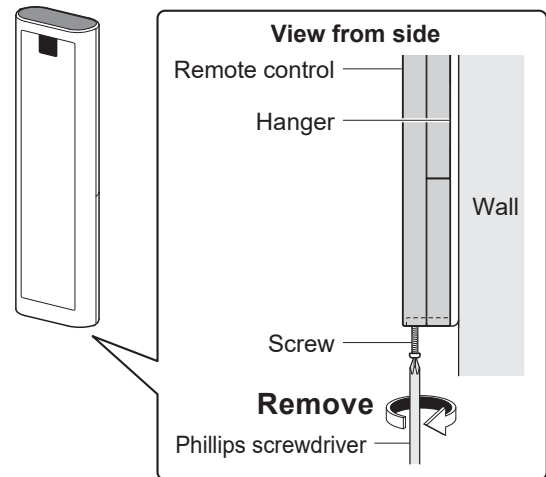

- 2) Remove the remote control from the hanger. Proceed with step 1.1 to 1.3 as shown on the left.

To secure the remote control again

Tighten and fix the screw.

Overtightening may cause damage to parts such as the hanger.

2. Turn on the power

TCF34270GEU
TCF34170GEU

2.1 Switch the breaker on the distribution board to ON.

► The wand extends and then retracts.

2.2 Check the "Power" LED illuminates.

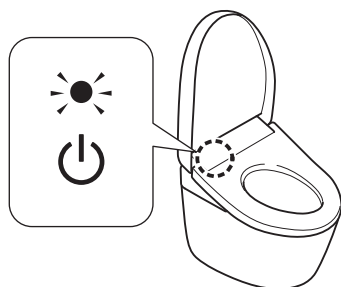

If the light is off

1) Remove the cover on the right side of the main unit, and flip the power switch to ON.

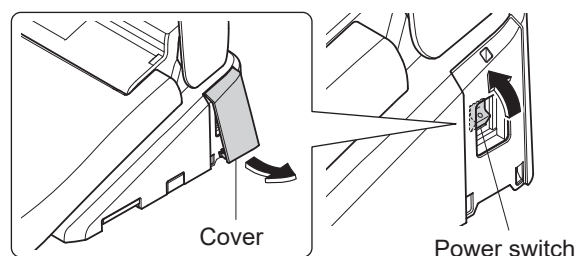

2) Reinstall the cover.

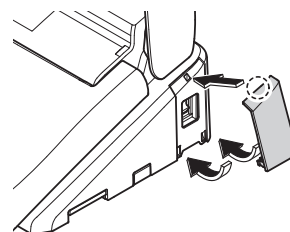

If the light is off, but the power switch is "ON"

Switch "Power" to "ON" using the remote control.

To operate from the back of remote control

 Press "Power ON/OFF" button about 3 seconds or longer.

To operate from the front of remote control

Recommended if the remote control is secured to prevent theft, etc.

 Press "Oscillating cleansing" button about 10 seconds or longer.

Preparation

2. Turn on the power (Continued)

TCF34120GEU

- 2.1** Insert the power plug.
▶ The wand extends and then retracts.

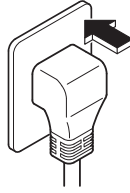

- 2.2** Check the "Power" LED illuminates.

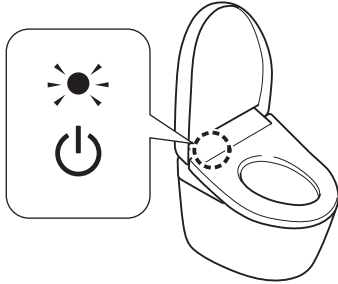

If the light is off

Switch "Power" to "ON" using the remote control.

To operate from the back of remote control

 Press "Power ON/OFF" button about 3 seconds or longer.

To operate from the front of remote control

Recommended if the remote control is secured to prevent theft, etc.

 Press "Oscillating cleansing" button about 10 seconds or longer.

TCF34120GGB

- 2.1** Switch the breaker on the distribution board to ON.

▶ The wand extends and then retracts.

- 2.2** Check the "Power" LED illuminates.

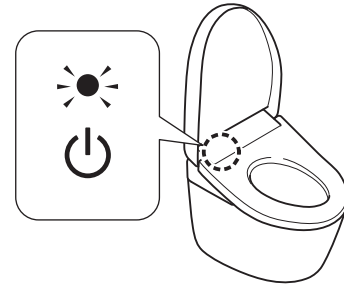

If the light is off

Switch "Power" to "ON" using the remote control.

To operate from the back of remote control

 Press "Power ON/OFF" button about 3 seconds or longer.

To operate from the front of remote control

Recommended if the remote control is secured to prevent theft, etc.

 Press "Oscillating cleansing" button about 10 seconds or longer.

3. Open the shutoff valve

TCF34270GEU

TCF34170GEU

3.1 Fully open the shutoff valve.

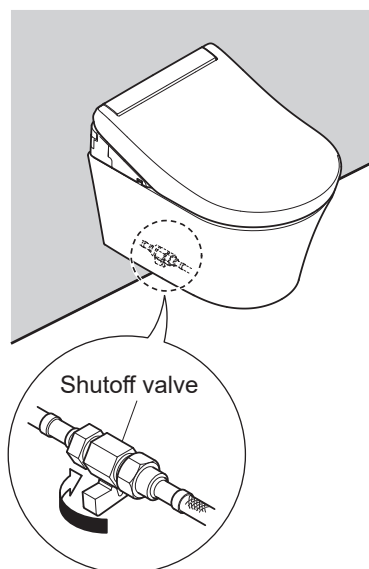

TCF34120GEU

TCF34120GGB

3.1 Fully open the shutoff valve.

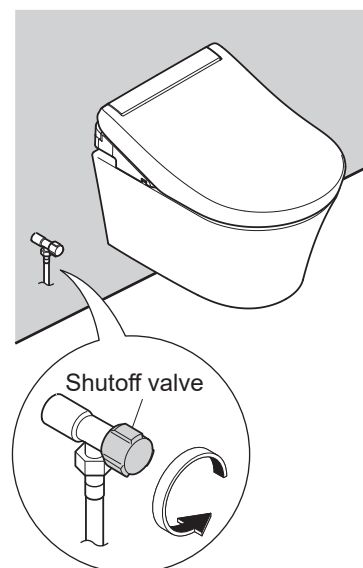

How to turn off the product

TCF34270GEU

TCF34170GEU

To turn the power "OFF"

- 1) Remove the cover on the right side of the main unit, and flip the power switch to "OFF".
 - ▶ The "Power" LED is unilluminated.

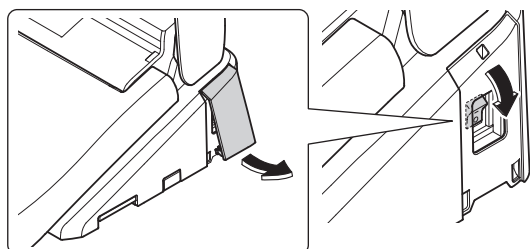

- 2) Reinstall the cover. (→Page 15)

TCF34120GEU

To turn the power "OFF"

- Unplug the power plug.
- ▶ The "Power" LED is unilluminated.

TCF34120GGB

To turn the power "OFF"

- Switch the breaker on the distribution board to OFF.
- ▶ The "Power" LED is unilluminated.

Basic Operations

Using the Remote Control

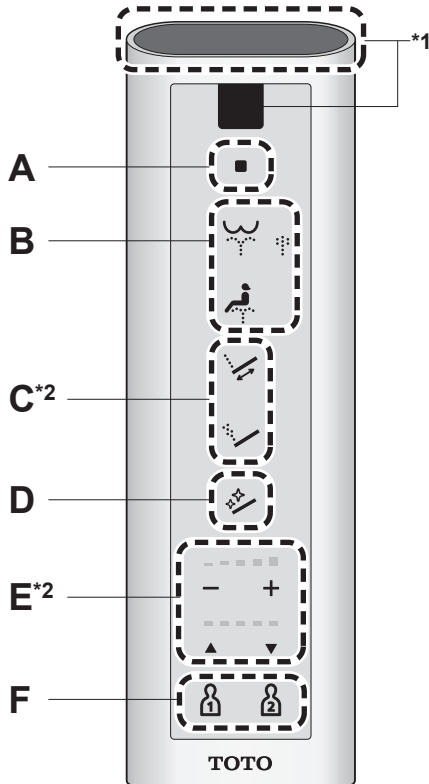



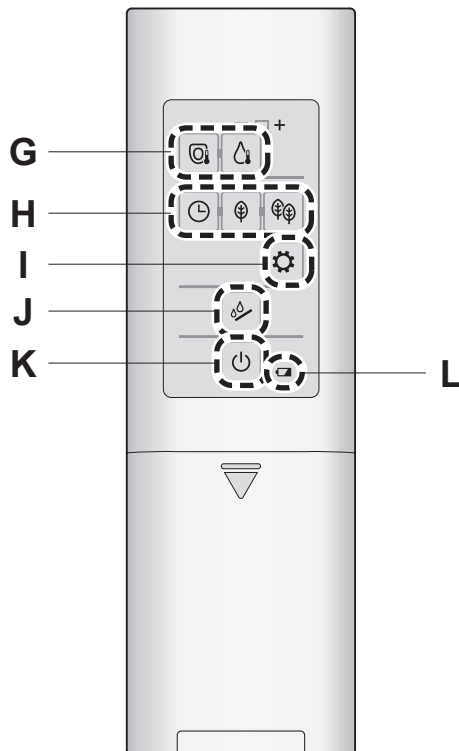

Remote control back side





Operate the controls on the remote control; a beep sounds when the main unit receives the signal.

A  **Stop**
Stops B operation.

B  **Rear cleansing**
Cleanses your rear.
 **Rear soft cleansing**
Cleanses your rear with mild water pressure.

The setting changes between  and  each time the  is pressed.

 **Front cleansing**
Serves as a bidet for ladies.

C  **Oscillating cleansing**
The wand moves back and forth to cleanse your rear thoroughly.

 **Pulsating cleansing**
Cleanses with the water pressure pulsating between soft and strong.

The setting changes between "ON" and "OFF" each time the button is pressed.

Note: Sitting back on the toilet seat makes it easier to adjust the wand position and to reduce splashing.

D  **Wand CLEAN**
Cleans the wand with "EWATER+"*3.

After wand cleaning, water comes out from around the wand.

When the "Wand CLEAN" function starts to operate after pressing the button, the Wand CLEAN LED flashes. (→Page 12)

Note: This function will operate automatically after using the cleansing functions (Rear cleansing, Front cleansing, etc.). (→Page 20 "Auto wand CLEAN")

Note: To clean the wand with it extended. (→Page 36 "Wand cleaning")

*1 Remote control transmitter (Front side, Top side)

*2 While using B, these buttons and their functions can be operated.

E Water pressure adjustment

 You can adjust the water pressure to one of five levels.
- + [-] Softer, [+] Stronger

 After you press the "Water pressure adjustment" button, the set position will light for 10 seconds.
- +

Wand position adjustment

 You can adjust the washing position to 5 different points between the front and the rear, using the [**▲**] and [**▼**] buttons.
▲ ▼

 After you press the "Wand position adjustment" button, the set position will light for 10 seconds.
▲ ▼



Once use of the remote control is finished, the settings will return to the initial setting (3rd position) after a while, not exceeding a maximum of 5 minutes.

Note: Sitting back on the toilet seat makes it easier to adjust the wand position and to reduce splashing.



F   Personal setting lock

You can store your preferred "Wand position", "Water pressure" and "Warm water temperature" settings.

To store a setting



While cleansing is in progress, set your preferred "Wand position", "Water pressure" and "Warm water temperature" and then press and hold  or  for 2 seconds or longer.

To use

Press  or , and then press the button for the cleansing you want to use.

The "Wand position" and "Water pressure" lamps will light up for about 10 seconds in their set positions, and the "Warm water temperature" display switches.

This section is an overview of the settings that can be configured with the remote control. See the corresponding pages for the detailed descriptions.

G  Toilet seat temperature
 Warm water temperature

Adjust temperatures (→Page 22)

H  Timer energy saver

 Auto energy saver

 Auto energy saver+

Saving energy (→Page 26)

I  Setting confirmation
 The current setting can be discerned from the LEDs.

J  Wand cleaning

To clean the wand with it extended. (→Page 36)
 When exchanging the spray nozzle (→Page 46)

K  Power ON/OFF
 Pressing it about 3 seconds or longer turns the power on/off.
 ► If the remote control is secured to prevent theft (→Page 15 Step 2-2.2)

L  Low battery warning mark
 (→Page 48)

*3 What is meant by "EWATER+" ? (→Page 21)

Basic Operations

Mechanism of Auto Functions

"EWATER+" is used automatically to clean the wand.

TCF34270GEU

1. As you sit*¹



Deodorizer
Pre-mist

Deodorizer

Starts the deodorizer



Removing odors inside the bowl unit.

Note: Filter needs regular maintenance. (→Page 37)

Pre-mist*³

Pre-mist

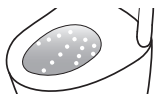

A mist is automatically sprayed inside the bowl unit to make it more difficult for dirt to adhere.

2. As you stand up*¹



Deodorizer
(Auto power deodorizer)
Auto wand CLEAN

Deodorizer

After about 10 seconds

Starts the auto power deodorizer



It stops after about 60 seconds.

Auto wand CLEAN

Only when the cleansing functions are used.

After about 25 seconds

The wand extends to clean itself with "EWATER+" that comes out of the base*²

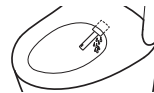

Note: When the "Auto wand CLEAN" function starts to operate, the Wand CLEAN LED flashes. (→Page 12)
"EWATER+" can also be used by pressing the remote control button. (→Page 18 "Wand CLEAN")

*1 Water comes out from around the wand.

*2 When the cleansing functions (Rear cleansing and Front cleansing etc,) have not been used in 8 hours, the wand is cleaned automatically. Water comes out from around the wand.

**TCF34170GEU, TCF34120GEU
TCF34120GGB**

1. As you sit*1



2. As you stand up*1



Auto wand CLEAN

Auto wand CLEAN

Only when the cleansing functions are used.

After about 25 seconds

The wand extends to clean with the "EWATER+" that comes out of the base*2



Note: When the "Auto wand CLEAN" function starts to operate, the Wand CLEAN LED flashes. (→Page 12)
"EWATER+" can also be used by pressing the remote control button. (→Page 18 "Wand CLEAN")

Operation under the default settings is described in "Mechanism of Auto Functions".

These mechanisms be changed.
(→Pages 24–32 "Changing Settings")

What is meant by "EWATER+" ?

This water containing hypochlorous acid generated from chloride ions in tap water, is widely used for cleaning and disinfecting items such as food, utensils and baby bottles.

- Well water may not deliver the required effect. (Because the level of chloride ions is low.)
- "EWATER+" helps to minimize dirty surfaces, but does not eliminate the need to clean completely.
- The effect and duration vary depending on the usage environment and conditions.

*3 The pre-mist will not spray for about 90 seconds after you stand up from the toilet seat.

Temperature Adjustment

Toilet Seat, Warm Water

Three different temperature levels (High, Medium, Low) and "OFF" setting can be selected.

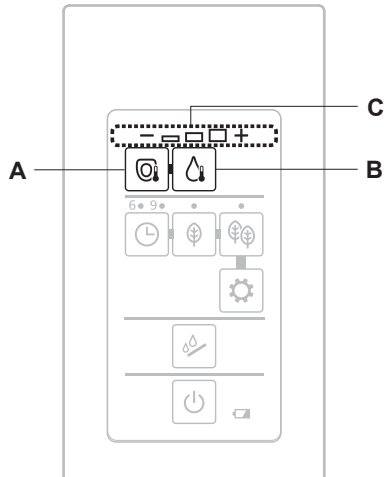

- A Toilet seat temperature button
(When you want to adjust the toilet seat temperature)
- B Warm water temperature button
(When you want to adjust the warm water temperature)
- C Displaying the temperature level of the pressed button

Adjusting the temperature

1. Remove the remote control from the hanger.
 - ▶ If the remote control is secured to prevent theft. (→Page 14)
2. Choose and press the button of the temperature that you want to set from the ("Toilet seat temperature" button), ("Warm water temperature" button).
 - ▶ The current temperature level appears.

3. Press the button selected in step 2 repeatedly until a desired temperature level illuminates.

▶ The setting changes each time the button is pressed once

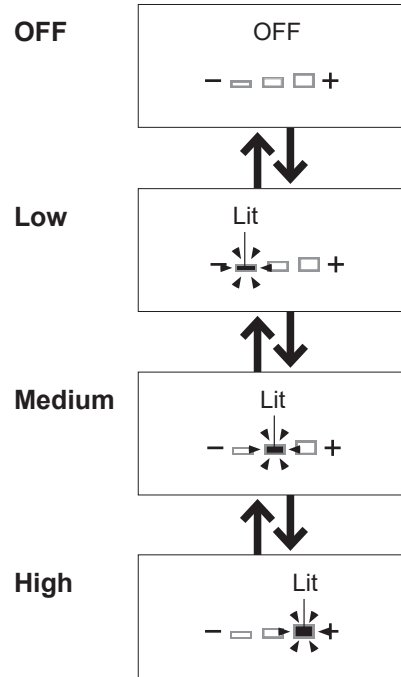

Settings complete

▶ When seat temperature is set, the SEAT LED illuminates.

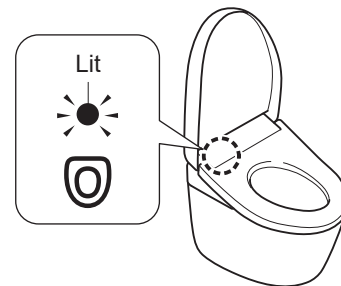

Note: If the button is not pressed for about 10 seconds, the "Temperature adjustment" LED will go off, but the setting will be retained.



If the "Temperature adjustment" LED goes out before the setting is completed, start all over again at step 2.

4. Mount the remote control in the hanger.

▶ If the remote control is secured to prevent theft. (→Page 14)

To turn the warm water temperature*1 and toilet seat temperature "OFF"

1. Remove the remote control from the hanger.
 - ▶ If the remote control is secured to prevent theft. (→Page 14)

2. Select a temperature button you want to turn "OFF" from  ("Toilet seat temperature" button),  ("Warm water temperature" button) and press it.
 - ▶ The current temperature level appears.

3. Press the button selected in step 2 repeatedly until the temperature level is set to "OFF".
 - ▶ The setting changes each time the button is pressed once

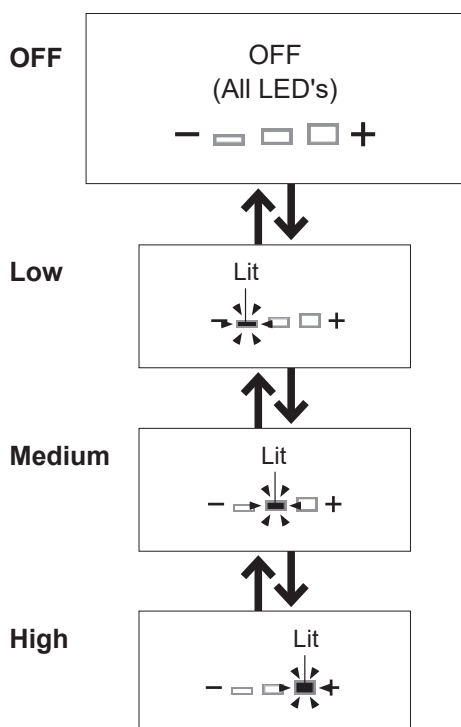

Settings complete

- ▶ When seat temperature is OFF, the SEAT LED is unilluminated.

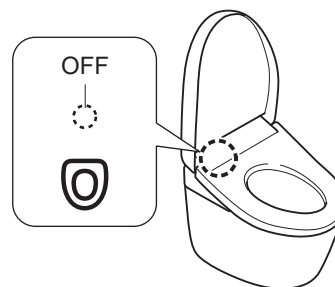

4. Mount the remote control in the hanger.
 - ▶ If the remote control is secured to prevent theft. (→Page 14)

If adjusting the temperature does not warm up the toilet seat.

- ▶ Is the energy saver set to "ON"? (→Page 26)

*1 To prevent condensation, the water temperature does not drop below 20 °C even when set to "OFF".

Changing Settings

Setting List

Setting Types	Available Settings Bold: Initial settings	Applicable Model
Auto energy saver (→Page 28)	ON/OFF	All models
Auto energy saver+ (→Page 28)	ON/OFF	
Timer energy saver (→Page 29)	ON/OFF	
Auto wand CLEAN (→Page 30)	ON/OFF	
Pre-mist (→Page 30)	ON/OFF	TCF34270GEU
Deodorizer (→Page 31)	ON/OFF	
Auto power deodorizer (→Page 31)	ON/OFF	
Beep sound (→Page 32)	ON/OFF	All models
Personal setting lock (→Page 32)	ON/OFF	

To change the settings, check that the LEDs on the control panel are flashing! *1

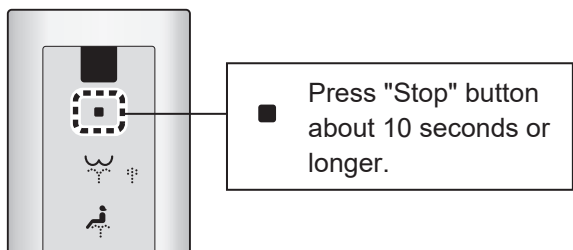

► All LEDs on the control panel flash.*2

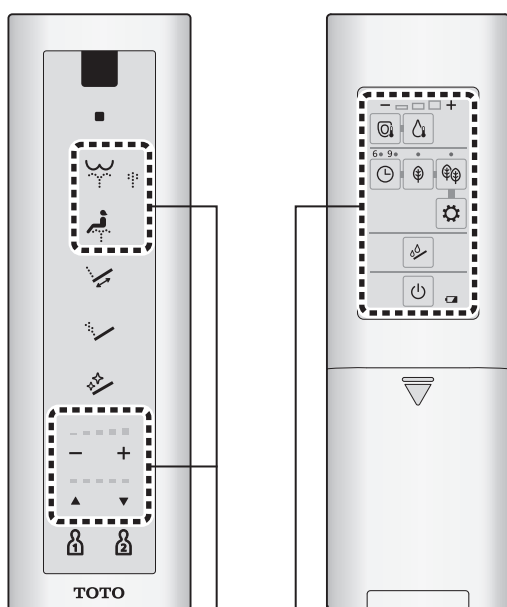

Settings cannot be changed unless all LEDs flash

► Setting buttons (→Pages 28–32)

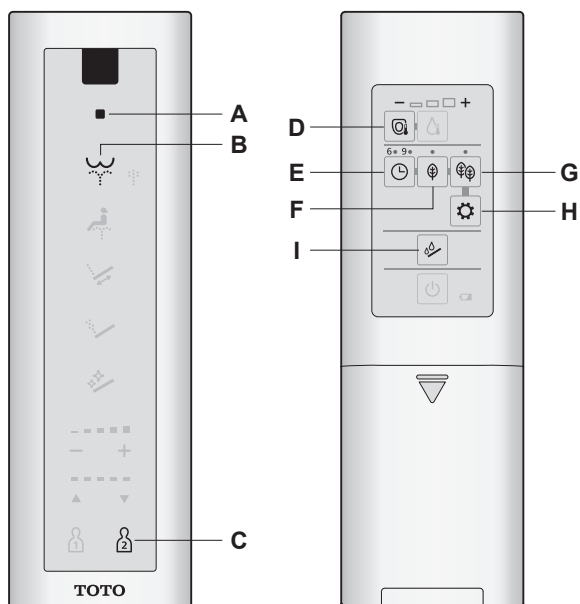

- A Stop button
- B Rear cleansing button
- C Personal setting lock 2 button
- D Toilet seat temperature button
- E Timer energy saver button
- F Auto energy saver button
- G Auto energy saver+ button
- H Setting confirmation button
- I Wand cleaning button

*1 Settings for energy saver features are excluded.

*2 During setting, if the next button is not pressed within about 60 seconds, the light will stop flashing. If you fail to complete the setting, redo from the step 1.

Changing Settings

The energy saver features

"Auto energy saver", "Auto energy saver+" or "Timer energy saver" can be selected.

To save energy, the temperature of the toilet seat becomes low (or "OFF").

Note: Even if the energy saver is activated (with the toilet seat heater set to Low or OFF), the toilet seat will be temporarily heated when you sit on it. (To reach the set temperature, the toilet seat takes about 15 minutes.) The LED indication on the main display returns to the state for when the energy saver is on.

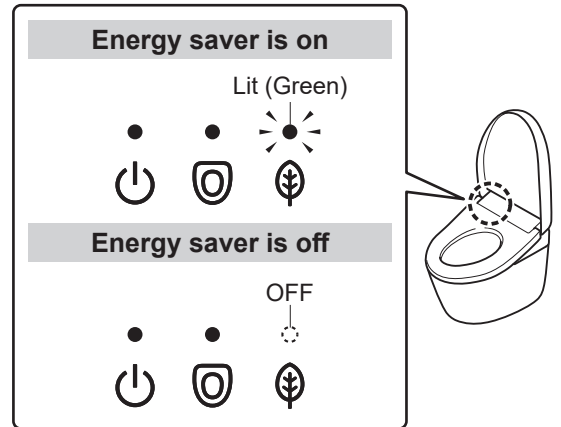

Auto energy saver

You want the product to save energy automatically

The product detects time periods with infrequent use and lowers the toilet seat temperature automatically.

It takes about 10 days for the product to determine the periods when it is used relatively less frequently.

When energy saver is in operation

Main display

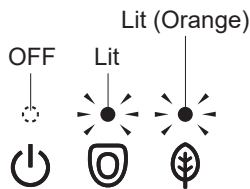

Toilet seat heater



Example

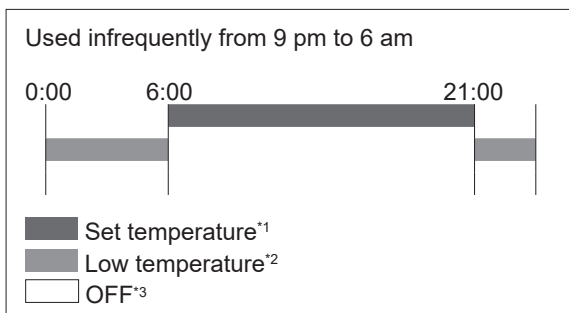

Auto energy saver+

You want to save more energy

In addition to the "Auto energy saver" feature, it automatically turns off the toilet seat heater during time periods when the toilet is not used.

When energy saver is in operation

Main display

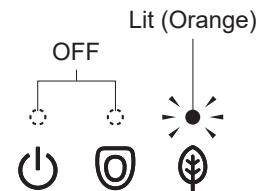

Toilet seat heater

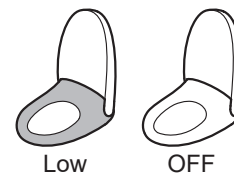

Example

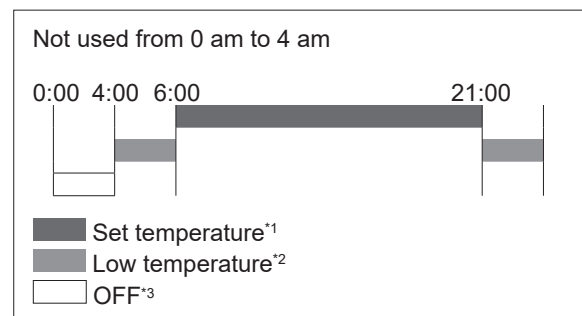

*1 The toilet seat temperature settings on pages 22, 23.

*2 The time period when the toilet seat heater is set to a "Low".

*3 The time period when the toilet seat heater is set to a "OFF"

Timer energy saver

You want to save energy only for a preset duration of time. (6 hours, 9 hours)

Once the time is set, the toilet seat heater turns off automatically during the set time period every day.

When energy saver is in operation

Main display

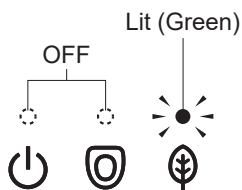

Toilet seat heater



Example

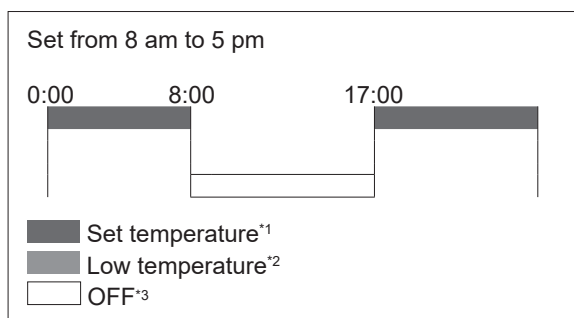

Timer energy saver and Auto energy saver / Auto energy saver+

You want to save the maximum amount of energy possible?

When both "Timer energy saver" and "Auto energy saver / Auto energy saver+" are set, "Auto energy saver / Auto energy saver+" operates when "Timer energy saver" is not operating.

When energy saver is in operation

Main display

During "Auto energy saver / Auto energy saver+":

- ▶ Same LED indication as "Auto energy saver / Auto energy saver+"

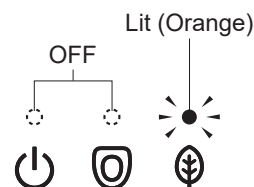

During "Timer energy saver":

- ▶ Same LED indication as "Timer energy saver"

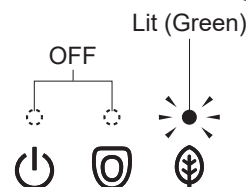

Toilet seat heater

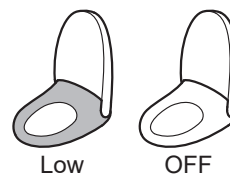

Example

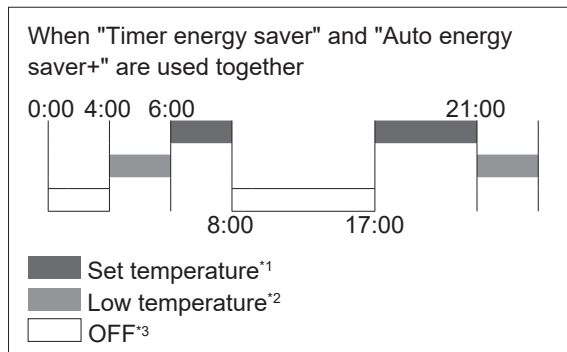

Changing Settings

How to Set

Auto energy saver

1. 

Press "Auto energy saver" button.

- ▶ The setting changes each time the button is pressed once.

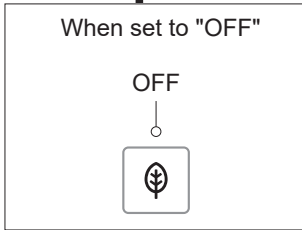
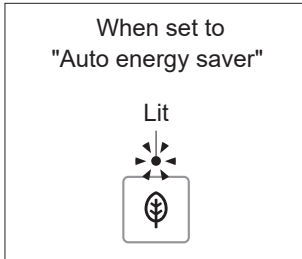

Settings complete

Auto energy saver+

1. 

Press "Auto energy saver+" button.

- ▶ The setting changes each time the button is pressed once.

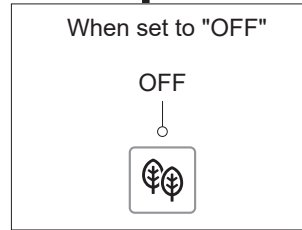
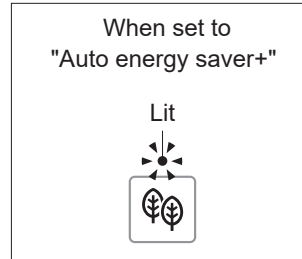

Settings complete

Timer energy saver

Set the Energy saver at the time you want to start it.

Example: To save energy from 1 am to 7 am (for 6 hours)

1.

When the time of the day reaches 1:00 am at night, press "Timer energy saver" button.

Press the "Timer energy saver" button repeatedly until the "6" LED illuminates.

- ▶ The setting changes each time the button is pressed once.

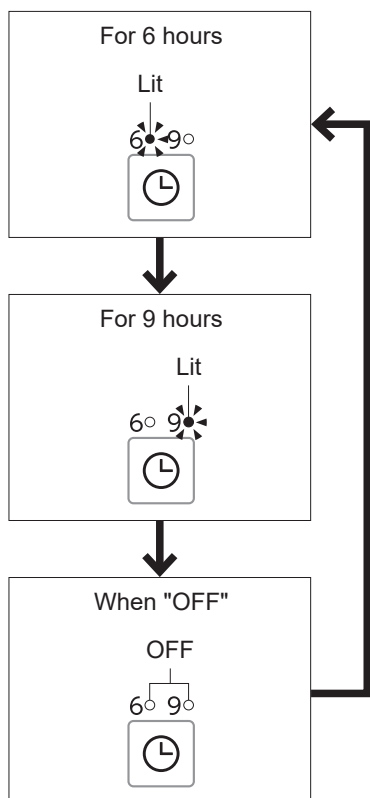



Settings complete

Changing Settings

Auto wand CLEAN*1

Set whether or not to clean the wand automatically

1. ■ Press "Stop" button until all LEDs on the remote control start flashing. (about 10 seconds)

2.  and  Press "Timer energy saver" button and "Setting confirmation" button at the same time.

- ▶ The setting changes each time the button is pressed once.

Set whether or not to clean the wand automatically

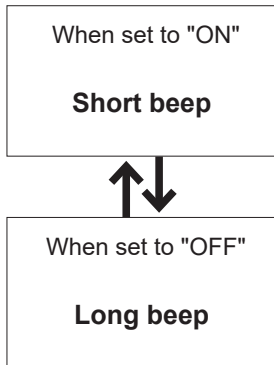



3. ■ Press "Stop" button.
Settings complete

Pre-mist

Set whether or not to spray mist in the bowl unit automatically

1. ■ Press "Stop" button until all LEDs on the remote control start flashing. (about 10 seconds)

2.  and  Press "Auto energy saver" button and "Setting confirmation" button at the same time.

- ▶ The setting changes each time the button is pressed once.

Set whether or not to spray mist in the bowl unit automatically

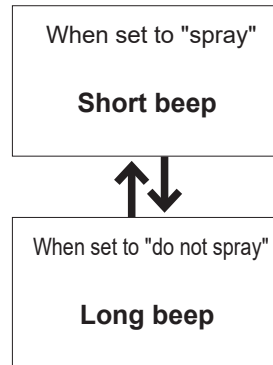

3. ■ Press "Stop" button.
Settings complete

*1 When "Auto wand clean" is set to "OFF", the "Wand CLEAN" LED turns off .

Deodorizer

Set whether or not to deodorize automatically after sitting on the toilet seat

1. ■ Press "Stop" button until all LEDs on the remote control start flashing. (about 10 seconds)

2.  Press "Wand cleaning" button about 5 seconds or longer.
 - ▶ The setting changes each time the button is held down longer than 5 seconds.

Set whether or not to deodorize automatically after sitting on the toilet seat

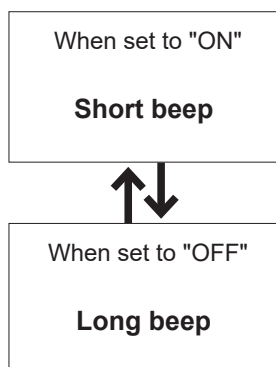

3. ■ Press "Stop" button.
Settings complete

Auto power deodorizer

Set whether or not to power deodorize automatically after standing up

1. ■ Press "Stop" button until all LEDs on the remote control start flashing. (about 10 seconds)

2.  Press "Toilet seat temperature" button.
 - ▶ The setting changes each time the button is pressed once.

Set whether or not to power deodorize automatically after standing up

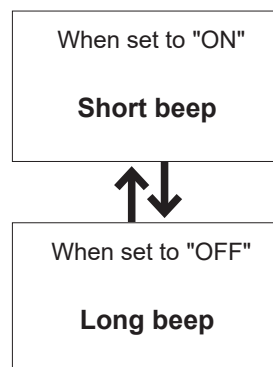

3. ■ Press "Stop" button.
Settings complete

Changing Settings

Beep sound*1

Set whether or not to make a beep sound

1. ■ Press "Stop" button until all LEDs on the remote control start flashing. (about 10 seconds)

2.  Press "Rear cleansing" button.

▶ The setting changes each time the button is pressed once.

Set whether or not to make a beep sound

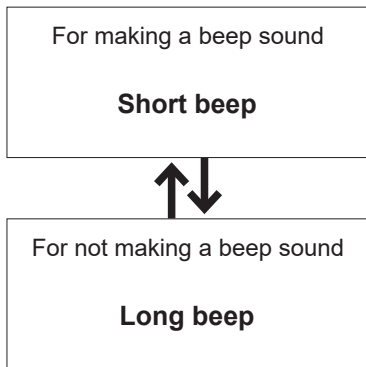

3. ■ Press "Stop" button.
Settings complete

Personal setting lock

Set whether or not to use the personal setting lock

1. ■ Press "Stop" button until all LEDs on the remote control start flashing. (about 10 seconds)

2.  Press "Personal setting lock 2" button for 5 seconds or longer.
▶ The setting changes each time the button is held down longer than 5 seconds.

Set whether or not to use the personal setting lock

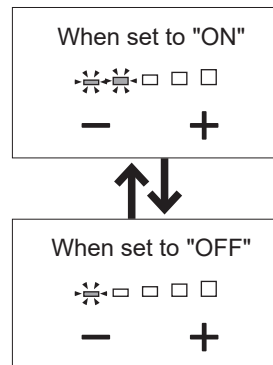

To confirm the option set, check the "Water pressure" LED

3. ■ Press "Stop" button.
Settings complete

*1 When you change each of the settings, set the electronic sound to "Make a beep sound".

Maintenance

Before maintenance

⚠ WARNING

Always turn off the power before maintenance or inspection.

Failure to do so may cause electric shock or malfunction, resulting in a breakdown.

For safety, turn the power OFF before maintenance.*2

When the power is turned OFF, the Power LED is unilluminated.

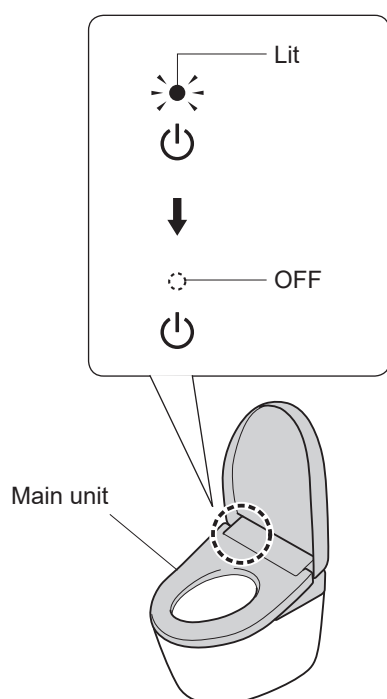

TCF34270GEU

TCF34170GEU

To turn the power "OFF"

Remove the cover on the left side of the main unit, and flip the power switch to "OFF".

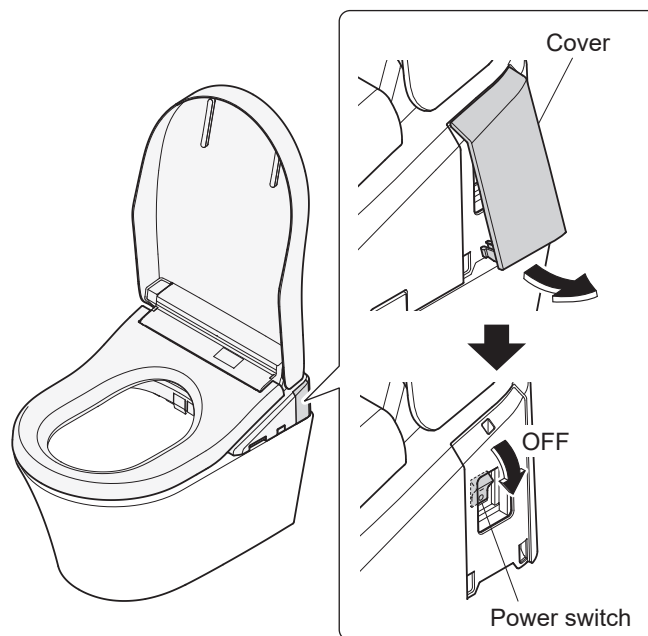

To turn the power "ON"

Flip the power switch to ON.

▶ The "Power" LED illuminates.

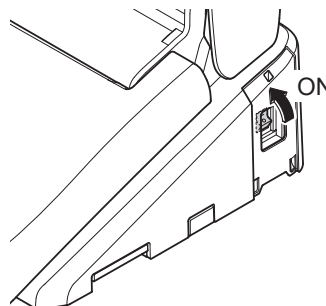

Reinstall the cover.

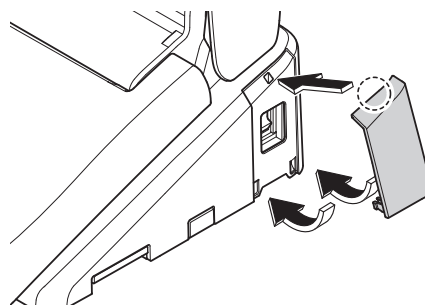

*2 Except when using "Wand cleaning", "Descaling mode" or "Spray nozzle".

Maintenance

TCF34120GEU

To turn the power "OFF"

Unplug the power plug.

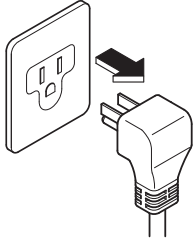

To turn the power "ON"

Insert the power plug.

▶ The "Power" LED illuminates.

TCF34120GGB

To turn the power "OFF"

Switch the breaker on the distribution board to OFF.

To turn the power "ON"

Switch the breaker on the distribution board to ON.

▶ The "Power" LED illuminates.

Power Plug*1

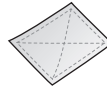

• Dry cloth



• Wet cloth

Approximately once a month

1. Unplug the power plug and wipe it with a dry cloth.

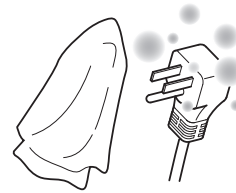

2. Insert the power plug.

▶ The "Power" LED illuminates.

! WARNING

Periodically remove dust from the blades and other parts of the power plug.

Unplug the power plug and wipe it with a dry cloth.

Fully insert the power plug.

When unplugging the power plug, hold the main body of the power plug.

Pulling the power cord may damage the power plug or power cord.

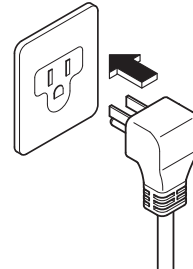

*1 For TCF34120GEU

Main Unit



- Soft cloth soaked in water

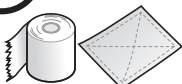

- Toilet paper
- Dry cloth
- Nylon scrubbing brush

May cause damage.

Approximately daily

1. Turn the power "OFF". (→Pages 33, 34)

2. Wipe with a soft cloth that has been soaked in water and wrung out thoroughly.

For heavy dirt

Wipe with a soft cloth soaked in diluted, pH neutral kitchen detergent, and then wipe with a soft cloth soaked in water.



- pH neutral kitchen detergent



- Paint thinner
- Benzene
- Powdered cleanser

3. Turn the power "ON". (→Pages 33, 34)

Attention

This product is an electric appliance. Be careful not to let water seep inside or leave detergent in the gap between the main unit and bowl unit.

May damage plastic parts or cause a malfunction.

When using a toilet cleaner to clean the toilet, rinse it off within 3 minutes and leave the toilet seat and toilet lid open.

Wipe off any cleaner that remains on the bowl unit.

If vapor from a toilet cleaner enters the main unit, it may cause a malfunction.

Do not push or pull the covers around the wand with undue force.

May cause damage or malfunction.

Wipe the back surface of the toilet seat and the toilet seat cushions with a soft cloth tightly wrung out with water.

Otherwise adhesion of dirt may result in discoloration.

Maintenance

Wand



- Soft cloth soaked in water

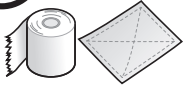

- Toilet paper
 - Dry cloth
 - Nylon scrubbing brush
- May cause damage.

Approximately once a month If you notice dirt (Wand cleaning)

1. Extend the wand.



To operate from the back of remote control



Press "Wand cleaning" button.

To operate from the front of remote control

Recommended if the remote control is secured to prevent theft, etc.

- 1)  Press "Stop" button until all LEDs on the remote control start flashing. (about 10 seconds)
- 2)  Press "Front cleansing" button for about 3 seconds or longer.

2. Wipe with a soft cloth that has been soaked in water and wrung out thoroughly.

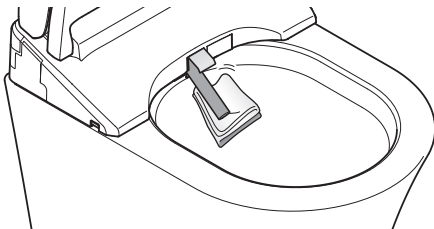

Attention

Do not pull, push or press the wand with excessive force.

May cause damage or malfunction.

3. 

Press "Stop" button on the front side of the remote control.

- ▶ The wand retracts.
- ▶ Water comes out from around the wand.

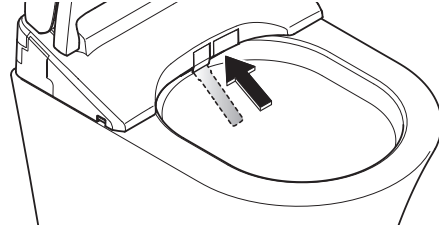

Filter

Approximately once a month

1. Turn the power "OFF". (→Pages 33, 34)

2. Remove the filter.

1) Hold the tab and pull outward.

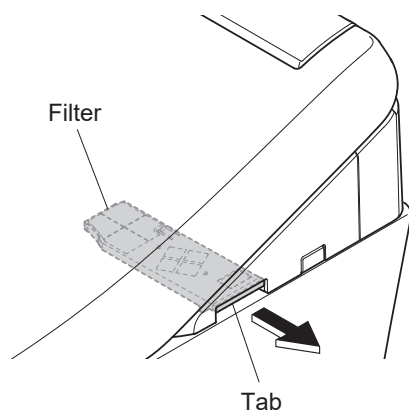

Attention

Do not pull with undue force.

Doing so may cause damage or malfunction.

3. Clean with a tool such as a toothbrush.

1) When washing with water, dry off all water before reinserting.

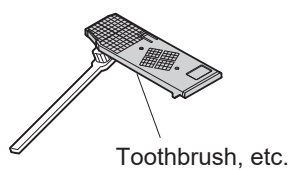

4. Reinsert the filter.

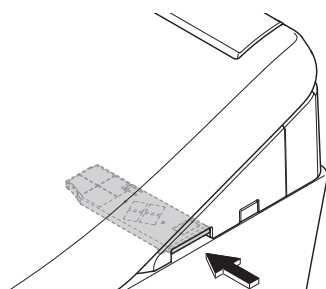

Push firmly until a click sound is heard.

5. Turn the power "ON". (→Pages 33, 34)

► The "Power" LED illuminates.

Maintenance

Gap between the Main Unit and Bowl Unit

You can remove the main unit to clean the top of the bowl unit and the bottom of the main unit.



- Soft cloth soaked in water

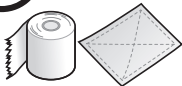

- Toilet paper
 - Dry cloth
 - Nylon scrubbing brush
- May cause damage.

Approximately once a month

1. Turn the power "OFF". (→Pages 33, 34)

CAUTION

If the power is not turned OFF, the unit may malfunction, causing a failure or electric shock.

2. Remove the main unit (a string is attached to the bottom of the main unit).

- 1) Pull the main unit toward you while pressing the "Main unit removal button".

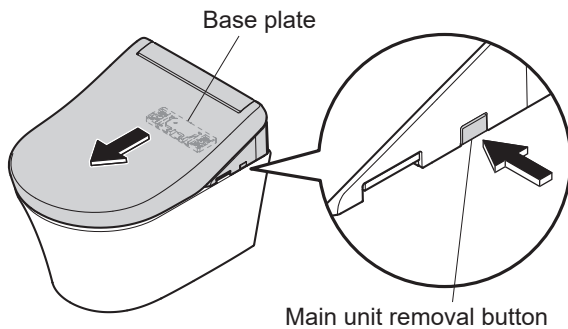

Attention

Do not pull the unit with undue force.
The main unit is connected to the base plate using a string.

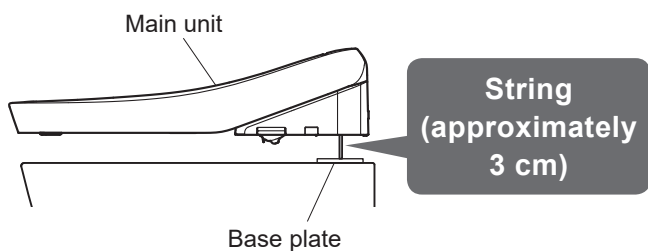

3. Clean the top of the bowl unit and the bottom of the main unit.

- 1) Wipe with a soft cloth soaked in a diluted, pH neutral kitchen detergent. Then, dry the surface with a soft cloth soaked in water so that no detergent remains.

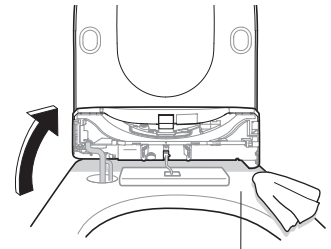
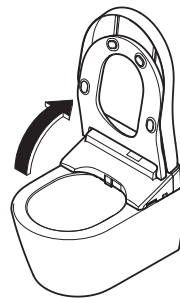

Top of the bowl unit

4. Mount the main unit.

TCF34270GEU
TCF34170GEU

- 1) Lift the main unit, then lower it straight down while threading the power cord and water supply hose into the recess on the bowl unit.

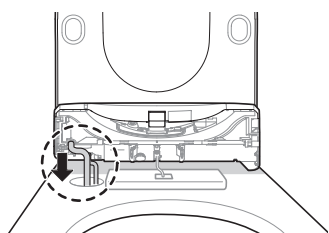

Attention

Be careful not to pinch the power cord.
Do not excessively bend the water supply hose.

- 2) Align the main unit with the center of the base plate and press it firmly onto the base plate until a click sound is heard.

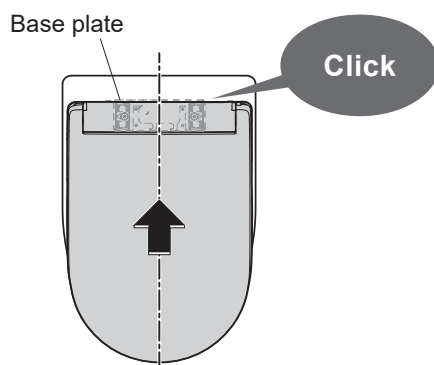

⚠ CAUTION

Push the main unit firmly on to the base plate until a click sound is heard.
 Failure to do so could cause the main unit to come loose resulting in injury.

- 3) After mounting, check that the main unit does not detach even when pulled.

TCF34120GEU
TCF34120GGB

- 1) Align the main unit with the center of the base plate and press it firmly onto the base plate until a click sound is heard.

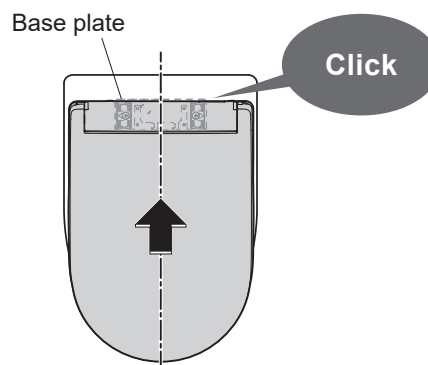

⚠ CAUTION

Push the main unit firmly on to the base plate until a click sound is heard.
 Failure to do so could cause the main unit to come loose resulting in injury.

- 2) After mounting, check that the main unit does not detach even when pulled.

5. Turn the power "ON". (→Pages 33, 34)

- ▶ The "Power" LED illuminates.

Maintenance

Gap between the Main Unit and the Toilet Lid

The toilet lid can be removed for thorough cleaning.



- Soft cloth soaked in water

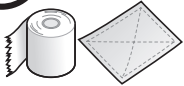

- Toilet paper
 - Dry cloth
 - Nylon scrubbing brush
- May cause damage.

Approximately once a month

1. Turn the power "OFF". (→Pages 33, 34)

2. Remove the toilet lid.

Slightly tilt the toilet lid to the front.

- A** Pull the left side outward.
- B** Disconnect the hinge from the tab and pull up.
- C** Disconnect the right side.

Hold with both hands

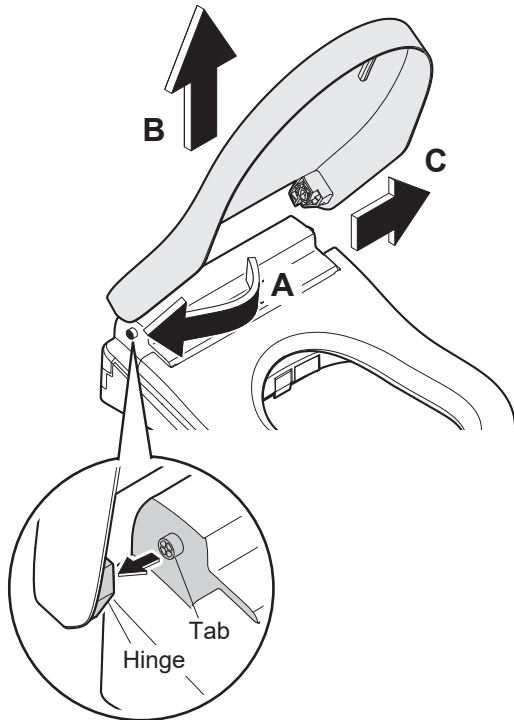

3. Wipe with a soft cloth that has been soaked in water and wrung out thoroughly.

4. Reinstall the toilet lid.

- D** Join the pin and the hinge on the right side. Slightly tilt the toilet lid to the front.
- E** While pulling out the left side,
- F** Mount by joining the hinge with the tab.

Attention

Be careful not to pinch your fingers.

Hold with both hands

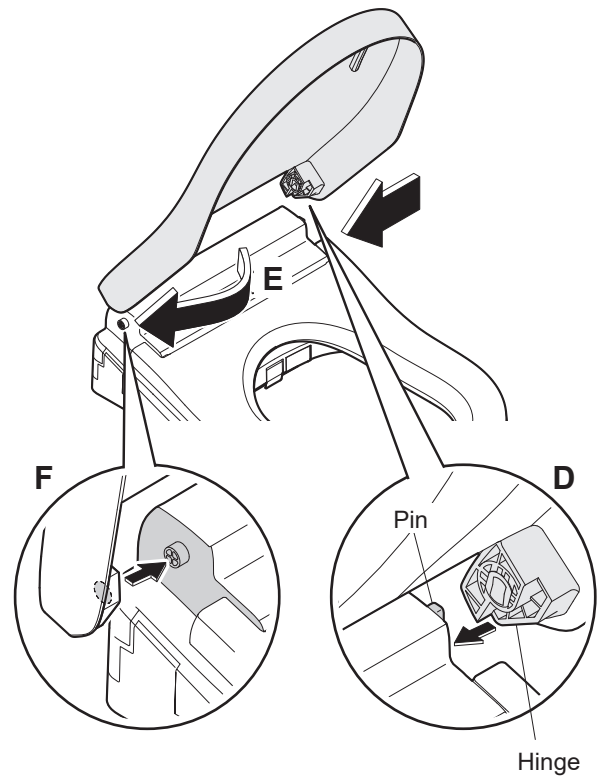

5. Turn the power "ON". (→Pages 33, 34)

- ▶ The "Power" LED illuminates.

6. Open and close the toilet lid to check the reinstallation.

Descaling mode

If you think the water pressure has weakened
"OR" When "Power" LED (orange) and "Energy
saver" LED (orange) flash

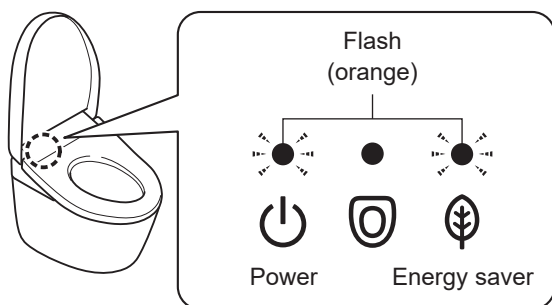

⚠ CAUTION

Do not perform descaling mode when the main unit is removed.
It may cause a failure in the unit.

Items to prepare



Beaker : included item



Funnel : included item



Descaling agent specified by
TOTO

Descaling agent specified by TOTO

Attention

Please use one of the following descaling agents at specified concentration.

Failure to do so may cause damage.

If you wish to use other agents, please contact us on the phone number on the back of this manual.

Product name	Manufacturer
Sido!® Universal-Entkalker (liquid)	Henkel AG & Co. KGaA
Bref POWER® Universal-Entkalker (liquid)	
Oust® ALL PURPOSE DESCALER (liquid)	

How to dilute

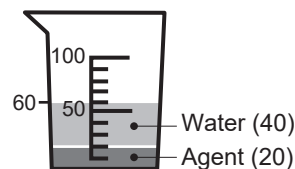

Pour and mix thoroughly

If the beaker is missing

Please use a clean cup and dilute 20 ml of agent with 40 ml of water.

Product name	Manufacturer
swirl® Anti Calc Bio Power Concentrate	Melitta Group
swirl® Anti Calc Bio flüssig	

How to dilute

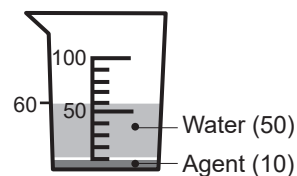

Pour and mix thoroughly

If the beaker is missing

Please use a clean cup and dilute 10 ml of agent with 50 ml of water.

[SIDOL] , [Bref POWER] and [OUST] are registered trademarks of [Henkel AG & Co. KGaA].

[swirl] is a trademark of company of the [Melitta Group].

Note: Please use the descaling agent properly according to the precautions from the manufacturer.

Maintenance

Descaling mode (Continued)

Note: Cleansing modes (rear, rear soft and front) cannot be used from step 1 until 60 minutes after step 9 of descaling is performed. Toilet can be flushed.

If the work is delayed for more than 30 minutes between steps 1 and 9, descaling agent will be drained to the toilet with a long beep sound to alert.

If you want to stop the work between steps 1 and 9, flip the power switch to "OFF", and then flip it to ON.

(→Pages 33, 34)

Descaling agent will be drained to the toilet with a long beep sound to alert. Cleansing modes (rear, rear soft and front) cannot be used while the long beep sound is alerting.

If you have set "not making a beep sound", be sure to switch to "making a beep sound" before starting the scale removal mode. (→Page 32)

1. ■ and ✨

Press "Stop" button and "Wand CLEAN" button at the same time about 10 seconds or longer.

- ▶ Water passage is drained.
(for about 30 seconds)
 - You will hear short beep sound.
 - Water comes out from around the wand.
 - "Power" LED (green) and "Energy saver" LED (green) will flash.
(The LEDs will continue to flash until the completion of the entire descaling process.)
- ▶ When water draining is completed, you will hear a long beep sound.

Descaling mode (1st time) 2-5

2. Dilute agent with water.
(→Please see **How to dilute** on page 41.)

3. Open the lid and remove cover and cap on the top face of product.

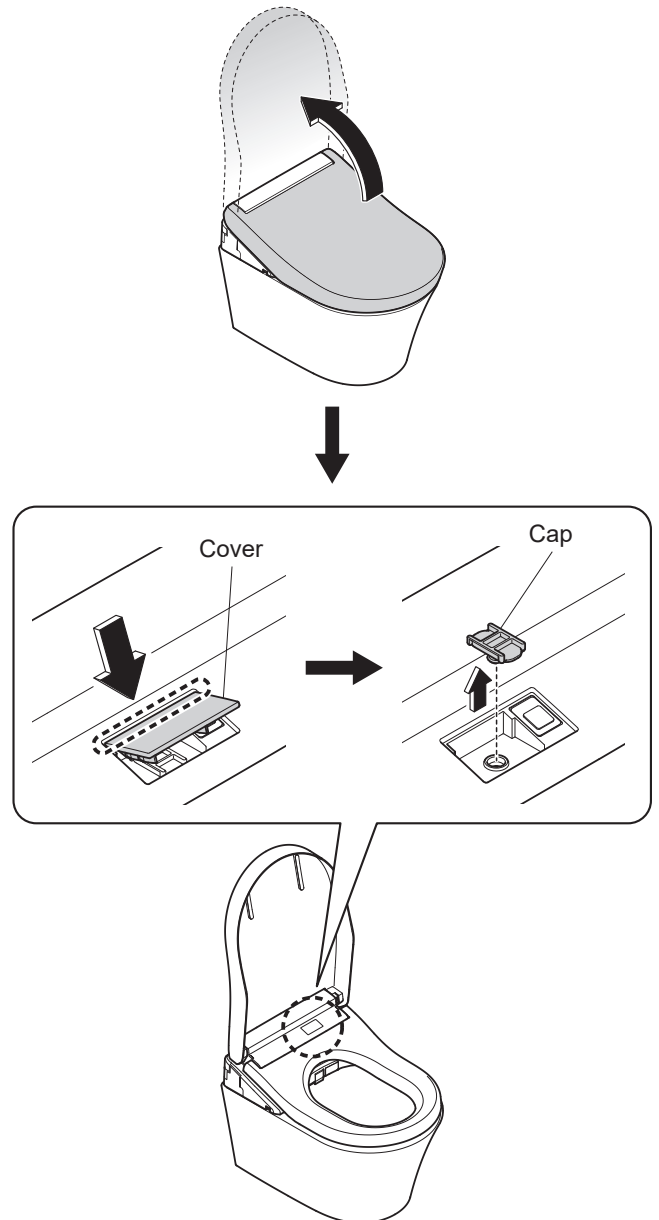

Attention

Please retain cover and cap.

4. Insert funnel and pour diluted agent.

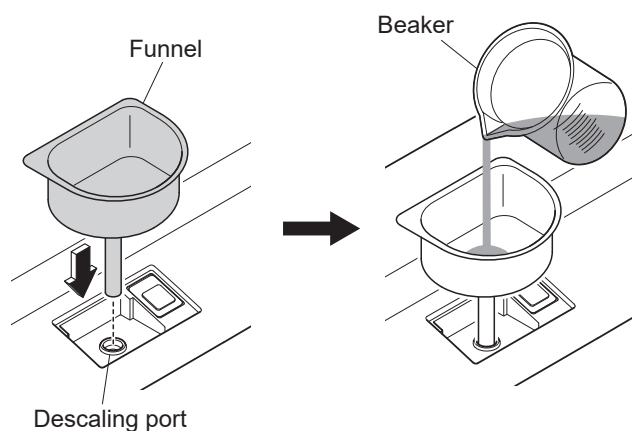

Attention

Please wait until funnel is empty.

Descaling will not work correctly.

If any cleaning agent is spilled on the product, please wipe it off with a soft cloth that has been soaked in water and wrung out thoroughly.

Failure to do so may cause discoloration.

5. ✨

Press "Wand CLEAN" button about 3 seconds or longer.

- ▶ Descaling will be performed. (for about 30 seconds)
 - You will hear short beep sound.
 - Water comes out from around the wand.
- ▶ When water draining is completed, you will hear a long beep sound.

Descaling mode (2nd time) 6–9

6. Dilute agent with water. (→Please see **How to dilute** on page 41.)

7. Pour diluted agent. (→see step 4 on page 43)

Attention

Please wait until funnel is empty.

Descaling will not work correctly.

8. Remove the funnel and put cap and cover back on.

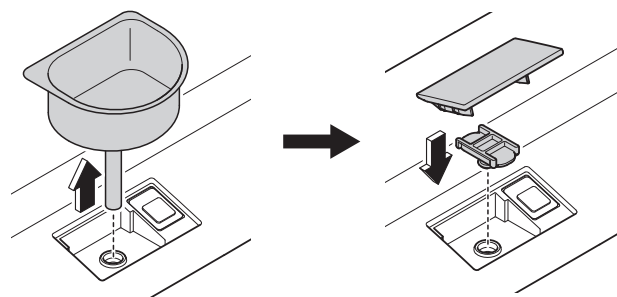

Attention

If any cleaning agent is spilled on the product, please wipe it off with a soft cloth that has been soaked in water and wrung out thoroughly.

Failure to do so may cause discoloration.

Maintenance

Descaling mode (Continued)

9.

Press "Wand CLEAN" button about 3 seconds or longer.

- ▶ Descaling will be performed.
(for about 60 minutes)
 - Water comes out from around the wand at about 20 minute intervals.
 - After about 60 minutes, descaling agent will be drained to the toilet.
 - After draining, you will hear a long beep sound, and the LEDs on product main body stop flashing.

Descaling complete

Attention

- 1. If the spray is still weak after performing Descaling mode:**
 - ▶ Clean the water filter drain valve. (→Page 45)
- 2. If the spray is still weak after performing 1:**
 - ▶ Clean the spray nozzle. (→Page 46)
- 3. If the problem does not resolve after performing 1 and 2, or if the "Power" LED (orange) and "Energy saver" LED (orange) start to flash after a while:**
 - ▶ Perform Descaling mode again. (→Page 41)

Water Filter Drain Valve

Approximately once every 6 months
If the water pressure is still weak even after performing descaling

1. Close the shutoff valve. (→Page 53)

- ▶ The water supply stops.

⚠ CAUTION

Do not remove the water filter drain valve while the shutoff valve is open.

Otherwise, water may leak out.

2. ✨

Press "Wand CLEAN" button.
(Release the pressure from the water supply pipe.)

- ▶ Water comes out from around the wand.

3. Turn the power "OFF". (→Pages 33, 34)

4. Remove the cover on the left side of the main unit and remove the water filter drain valve.

- ▶ Loosen the water filter drain valve with a flat-head screwdriver and then pull it.

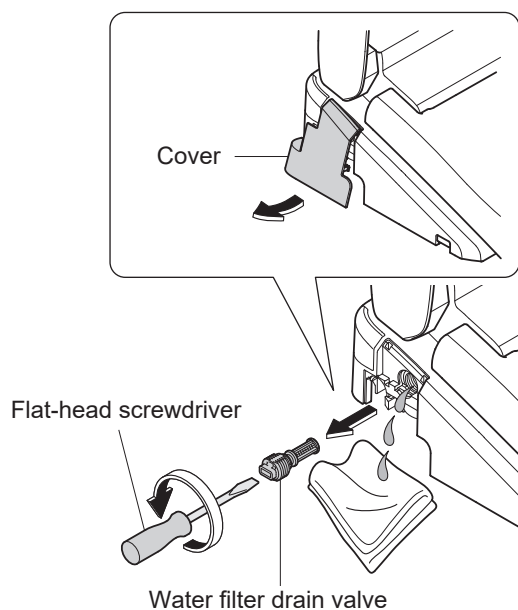

5. Clean the filter with a tool such as a toothbrush.

- ▶ Also, remove any dust from inside the hole of the water filter drain valve.

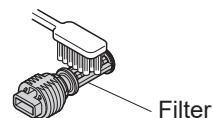

6. Reinstall the water filter drain valve and cover.

- ▶ Insert the water filter drain valve and use a flat-head screwdriver to tighten it securely.

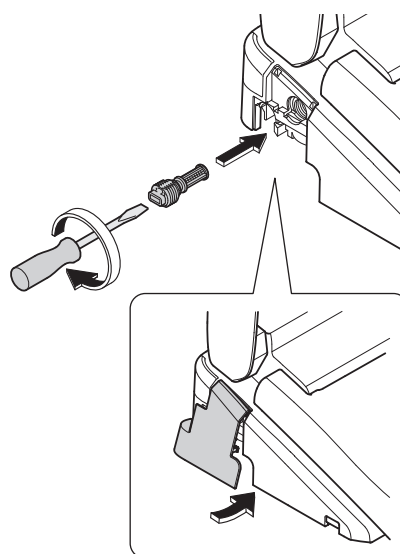

7. Turn the power "ON". (→Pages 33, 34)

8. Open the shutoff valve. (→Page 17)

Maintenance

Spray Nozzle

If the water pressure is still weak even after performing descaling and water filter drain valve cleaning

1. Remove the spray nozzle from the wand.

- 1) Extend the wand. (→see step 1 on page 36)
- 2) While holding the wand with a hand, press on both sides of the spray nozzle and slide it.

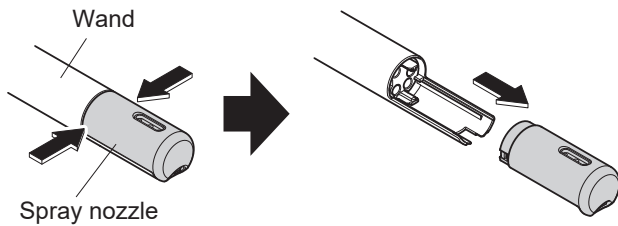

Attention

Do not pull with undue force.
May cause damage or malfunction.

2. Install a spray nozzle (for replacement).

Check that the gasket (black) is attached.



- 1) Hold the wand by hand and slide the replacement spray nozzle along the guide and push it in.
 - ▶ Install correctly until a click sound is heard.

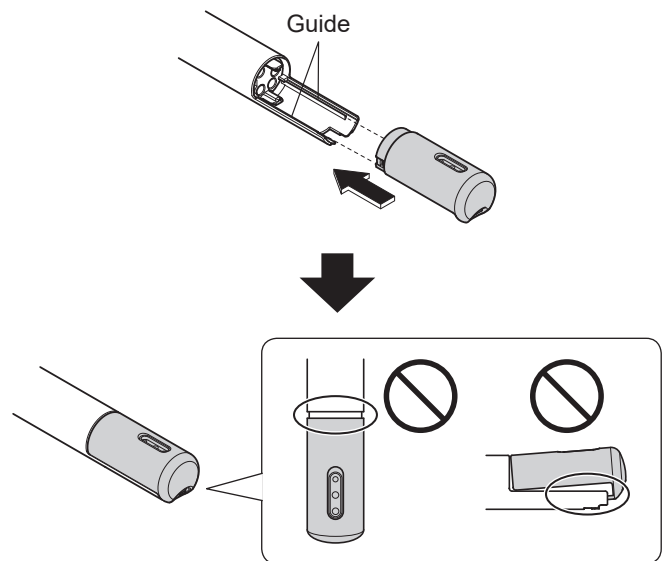

Attention

Do not push with undue force.
May cause damage or malfunction.

- 2) ■ Press "Stop" button on the front side of the remote control.
 - ▶ The wand retracts.
 - ▶ Water comes out from around the wand.

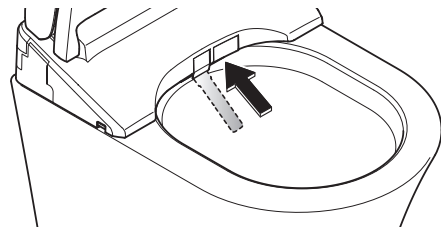

Attention

Keep the spare nozzle in safe place.

Cleaning the blocked Nozzle

Clean the removed spray nozzle using the descaling agent specified by TOTO (→Page 41).



- Descaling agent specified by TOTO (→Page 41)



- Other detergents

Attention
Do not disassemble the spray nozzle. May cause malfunctions.

What to Do?

If the water does not flow due to a water service interruption

1. Use a bucket to flush water.
2. If the water level is low after flushing, add more water.
 - ▶ Prevents odors.

Attention

When the water supply is restored, be sure to perform a flush.

To prevent waste from remaining in the drain pipe.

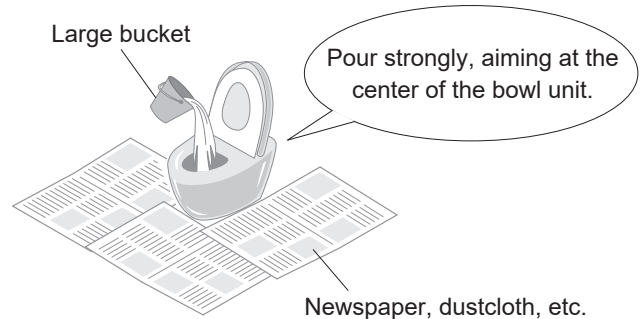

If you cannot operate with the remote control

If the low battery warning mark "  " on the back of the remote control is flashing, please replace the batteries.

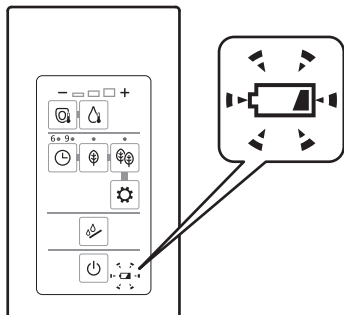

It is the time to replace the batteries.

Replacing the batteries

1. Turn the power "OFF". (→Page 17)
2. Remove the remote control from the hanger. (→Page 14)
3. Open the battery cover and replace the two AA batteries. (→Page 14)
 - ▶ The low battery warning mark is unilluminated.
4. Mount the remote control in the hanger.

5. Turn the power "ON". (→Pages 15, 16)
 - ▶ The "Power" LED illuminates.

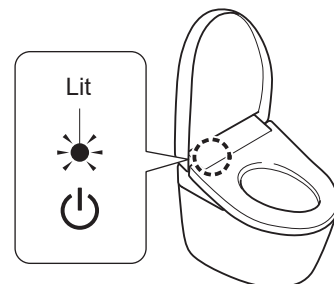

Attention

"ON" and "OFF" settings of the functions such as the energy saver function may be canceled when the batteries are replaced.

Set them again.

Freeze Damage Prevention

When the ambient temperature is likely to drop to 0 °C or lower, take measures to prevent freezing.

Attention

When the ambient temperature is likely to drop to 0 °C or lower, do not use the energy saver feature.
May damage the product.

Warm the bathroom or take measures against freezing so that the ambient temperature does not drop below 0 °C.

1. Close the shutoff valve. (→Page 53)
 - ▶ The water supply stops.

⚠ CAUTION

Do not remove the water filter drain valve while the shutoff valve is open.
Otherwise, water may leak out.

2.  Press "Wand CLEAN" button.
(Release the pressure from the water supply pipe.)
 - ▶ Water comes out from around the wand.

3. Turn the power "OFF". (→Page 17)

4. Remove the cover on the left side of the main unit and remove the water filter drain valve.
 - ▶ Loosen the water filter drain valve with a flat-head screwdriver and then pull it.

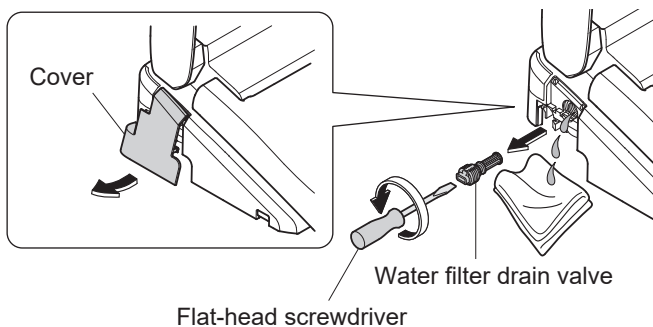

5. When water draining is completed, reinstall the water filter drain valve and cover.
 - ▶ Insert the water filter drain valve and use a flat-head screwdriver to tighten it securely.

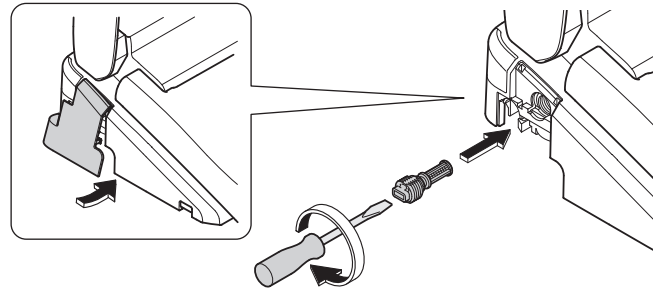

6. Turn the power "ON". (→Pages 15, 16)
 - ▶ The "Power" LED illuminates.

7. Set the toilet seat temperature to "High". (→Page 22)
 - ▶ To maintain the temperature, close the toilet seat and toilet lid after finishing work.

To use the product again

- ▶ The water needs to be resupplied. (→Page 51)

What to Do?

Long Periods of Disuse

If the toilet is in a location you will not visit for a long time, drain the water.

The water in the tank may cause malfunctions or become contaminated and cause skin irritation or other problems.

How to drain the water

1. Close the shutoff valve. (→Page 53)
 - ▶ The water supply stops.

CAUTION

Do not remove the water filter drain valve while the shutoff valve is open.
Otherwise, water may leak out.

2.  Press "Wand CLEAN" button.
(Release the pressure from the water supply pipe.)
 - ▶ Water comes out from around the wand.

3. Turn the power "OFF". (→Page 17)

4. Remove the cover on the left side of the main unit and remove the water filter drain valve.
 - ▶ Loosen the water filter drain valve with a flat-head screwdriver and then pull it.

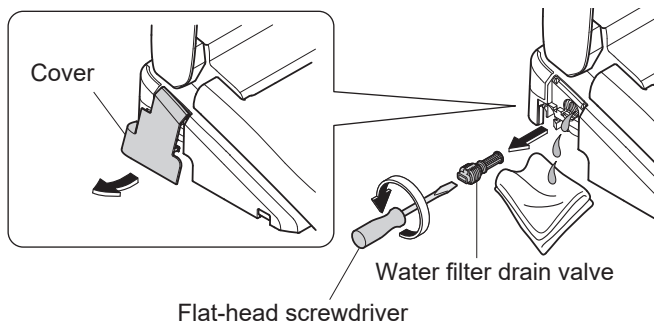

5. When water draining is completed, reinstall the water filter drain valve and cover.
 - ▶ Insert the water filter drain valve and use a flat-head screwdriver to tighten it securely.

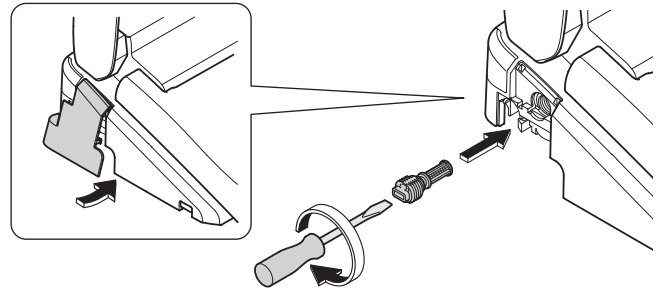

6. Pull out the water drain lever.
 - ▶ Water comes out from around the wand.
(about 20 seconds)

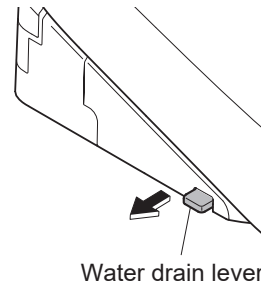

7. Release your hand to return the water drain lever to its original position.

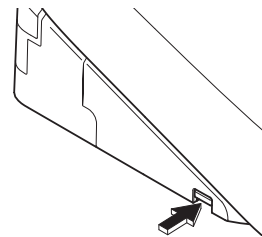

If water may get frozen

- ▶ Add antifreeze solution to the water in the bowl to prevent freezing.
(The antifreeze solution should not be flushed out. Collect it before using the toilet and dispose of it.)



To use the product again

- ▶ The water needs to be resupplied. (→Page 51)

Resupplying the Water

1. Open the shutoff valve. (→Page 17)
 - ▶ Check that water is not leaking from a pipe or the main unit.

2. If the power is not on, turn the power ON. (→Pages 15, 16)

3. Discharge water from the wand.
 - 1) Pressing down the left side of the toilet seat,
 - 2)  Press "Rear cleansing" button to discharge water from the wand.
 - ▶ Catch the water in a paper cup or other receptacle.
 - 3)  Press "Stop" button.

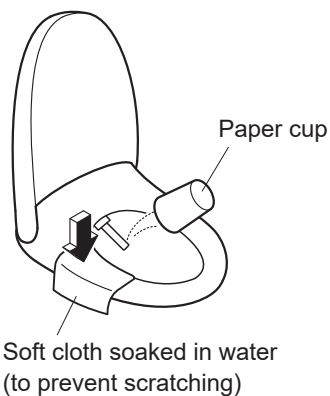

If the remaining water has frozen and no water comes out

- ▶ Heat the inside of the bathroom, and warm the water supply hose and shutoff valve using a cloth soaked in warm water.

What to Do?

How to remove the operation guide

To remove, follow the procedure below.

1. Turn the power "OFF". (→Page 17)
2. Remove the remote control from the hanger.
(→Page 14)
3. Remove the hanger and operation guide.

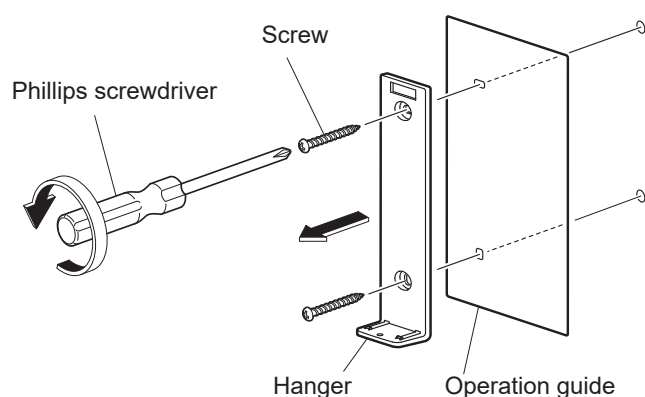

4. Screw the hanger on the wall.

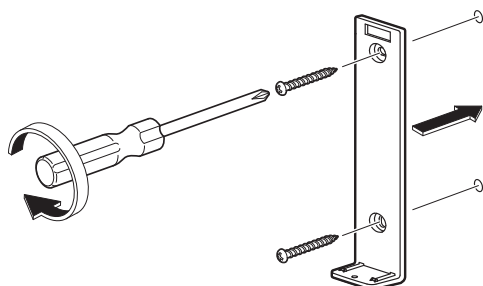

5. Mount the remote control in the hanger.

6. Turn the power "ON". (→Pages 15, 16)

▶ The "Power" LED illuminates.

To install back the operation guide, follow the procedure above.

▶ Install the operation guide at step 4.

Troubleshooting

First, try the actions described on pages 53–57. If the problem persists, consult the installer, seller, or TOTO Service (→see *contact information on the back cover*).

⚠ CAUTION

If a water leak occurs, close the shutoff valve.

TCF34270GEU

TCF34170GEU

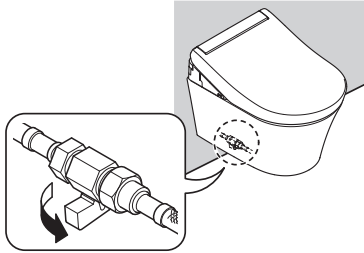

TCF34120GEU

TCF34120GGB

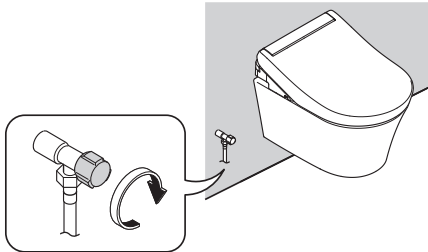

Please check first (A–C)

A: Is the Power LED illuminated?
Is the main unit working?

Is the breaker on the distribution board turned on?

- ▶ Check whether there is a power outage or the breaker has turned "OFF".

Is the power switch flipped to "OFF"?^{*1}

- ▶ Flip it to "ON". (→Page 15 step 2-2.2)

Is the "Power ON/OFF" setting "OFF"?

- ▶ Switch it to "ON" with the remote control. (→Page 15 step 2-2.2)

B: Is the Energy saver LED lit?

While the LED is lit, energy saver (→Page 26) is in operation, so the toilet seat temperature may be reduced or the heater may be turned off.

C: Is the remote control working?

Is the " " LED on the backside of the remote controller flashing?

- ▶ Replace the batteries. (→Pages 14, 48)

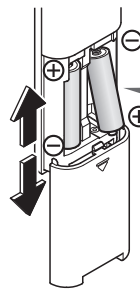

The remote control uses batteries to operate.

Is the remote control transmitter or the remote control receiver blocked?

- ▶ Remove obstructions, dirt, water droplets or any other blockages.

Remote control transmitter

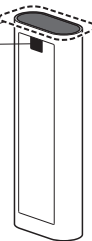

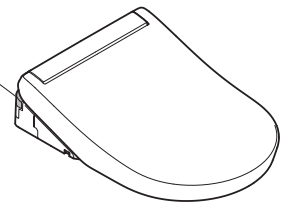

Remote control receiver



*1 Except TCF34120GEU and TCF34120GGB.

Troubleshooting

Rear Cleansing, Front Cleansing and Wand

Trouble	Please check
<p>The wand (or cleansing water) does not come out</p>	<p>When the temperature is low, it takes time for the wand to come out after the remote control button is pressed because the water must be warmed up first.</p> <hr/> <p>Has the toilet been sat "ON" and used continuously for 2 hours or longer? (If so, operation is stopped for safety purposes.)</p> <p>▶ Stand up from the seat and then use again.</p> <hr/> <p>If the water supply pressure drops significantly, for example if water is used elsewhere or if there is a water failure, the function may stop for safety.</p> <p>▶ Turn the power OFF and wait about 10 seconds before turning the power ON again. (→Pages 15–17)</p> <p>If the above symptom reappears</p> <p>There may be a malfunction.</p> <p>▶ Consult with TOTO Service. (→see contact information on the back cover)</p> <hr/> <p>The seat switch will not turn on unless you sit on the seat properly.</p> <p>▶ Sit back on the toilet seat. (→Page 11)</p> <hr/> <p>Are you using a toilet seat cover, a toilet lid cover or a seat for infants?</p> <p>▶ Remove any covers. When using a seat for infants or a soft highchair, remove after each use. (→Page 10)</p> <div style="text-align: right;">  </div> <hr/> <p> Are you pressing "Wand CLEAN" button?</p> <p> When you press "Wand CLEAN" button, "EWATER+" comes out from the vicinity of the wand to clean the wand.</p> <p>▶ To clean the wand with it extended, perform "Wand cleaning". (→Page 36)</p>
<p>The wand extends but the cleansing water does not come out / The cleansing water pressure is weak</p>	<p>Has a water failure occurred?</p> <p>▶ ■ Press "Stop" button on the remote control and wait until water service is restored.</p> <hr/> <p>Is the shutoff valve closed?</p> <p>▶ Fully open the shutoff valve. (→Page 17)</p> <hr/> <p>Perform Descaling mode. (→Page 41)</p> <hr/> <p>Is the water pressure set to a low level? (→Page 19)</p>
<p>The cleansing water is cold</p>	<p>Is the warm water temperature set to "OFF" or a low level? (→Page 22)</p> <hr/> <p>When the temperature of the water supply or the bathroom is low, the water temperature may be low when first sprayed.</p>
<p>Wash functions stop unintentionally during use</p>	<p>"Rear cleansing", "Rear soft cleansing" and "Front cleansing" stop automatically after 5 minutes of continuous use.</p> <p>Then the "Power" LED (Green) and the "Energy saver" LED (Green) on the display of the main unit flash about 60 seconds while hot water is prepared.</p> <p>▶ Wait until the LEDs on the display of the main unit light up solidly and then press the button again.</p> <hr/> <p>Does the seat switch have difficulty detecting?</p> <p>▶ Sit back on the toilet seat. If you get up slightly from the seat, or sit forward on the seat, the seating switch may temporarily stop detecting your presence. (→Page 11)</p>

*1 Except TCF34170GEU, TCF34120GEU and TCF34120GGB.

Water comes out unexpectedly from the wand

Water comes out from the area around the wand for several seconds after the Pre-mist has finished and after the user stand up from the toilet seat.¹

Is the "Wand CLEAN" LED on the main display flashing?

▶ "Auto Wand CLEAN" starts and the wand is cleaned. (→Page 20)

Toilet Seat and Toilet Lid**Trouble****Please check****The toilet seat is cold**

Is the toilet seat temperature set to "OFF" or a low level? (→Page 22)

Is energy saver in operation?

The energy saver feature is on when the "Energy saver" LED is on and the "Power" LED is off on the main display.

When you sit on the seat, the toilet seat heater is turned on temporarily and the seat is warmed in about 15 minutes. (→Page 26)

▶ You can turn it "OFF" if the energy saver feature is "ON". (→Pages 28, 29)

Have you been seated for a long time?

After about 20 minutes of sitting, the temperature starts reducing, and after about 1 hour, the toilet seat heater is turned "OFF".

▶ Stand up from the seat and then use again.

Is a toilet lid or seat cover installed?

▶ Remove any covers. (→Page 10)

Energy Saver**Trouble****Please check****The Energy saver LED does not light up**

Has the power to the product been turned "OFF" or was there a power outage?

The Energy saver LED on the main display may go off when the power is turned ON even if the energy saver feature is ON.

It will turn on within about 24 hours since the setting is retained.

The timer energy saver feature is not working

Have the batteries in the remote control been replaced?

"Timer energy saver" may be canceled when the batteries are replaced.

▶ Set the timer energy saver again at the time you want to start it. (→Page 29)

The auto energy saver+ or auto energy saver feature is not working

Because this function takes several days learning the usage conditions before starting energy saver, the amount of energy saving may be low, depending on the frequency of use.

▶ Check the energy saver setting. (→Pages 26, 27)

Troubleshooting

Deodorizer*1

Trouble	Please check
The deodorizer seems to be not working	<p>Is "Deodorizer" set to "OFF"?</p> <p>▶ Set to "ON". (→Page 31)</p> <hr/> <p>Even after sitting down, you do not hear operation sounds.</p> <p>▶ Sit back on the toilet seat. (→Page 11)</p> <p>If you hear an operation sound from the deodorizer, but odours are not removed.</p> <p>▶ Clean the filter. (→Page 37)</p>
A strange odour is emitted	<p>Are you using an air freshener or deodorizer that you purchased separately?</p> <p>Doing so may reduce the effectiveness of the product's deodorizer or cause strange odours.</p> <p>▶ Remove the air freshener or deodorizer.</p>
The auto power deodorizer feature is not working	<p>Is "Auto power deodorizer" set to "OFF"?</p> <p>▶ Set to "ON". (→Page 31)</p> <p>The auto power deodorizer starts about 10 seconds after you stand up from the toilet seat.</p>

Pre-mist*1, Auto wand CLEAN and Wand CLEAN

Trouble	Please check
Pre-mist is weak	Perform Descaling mode. (→Page 41)
Pre-mist is not sprayed	<p>Is "Pre-mist" set to "OFF"?</p> <p>▶ Set to "ON". (→Page 30)</p> <p>Perform Descaling mode. (→Page 41)</p>
The Wand CLEAN LED does not light up	<p>If the "Wand CLEAN" LED does not light up, it is time to replace the component that generates "EWATER+".</p> <p>▶ Consult the installer, seller, or TOTO Service (→see contact information on the back cover).</p>

Others

Trouble	Please check
Water is leaking from the plumbing connections	<p>If any nuts in a connection are loose, firmly tighten them with a tool such as a monkey wrench.</p> <p>▶ If the water leak does not stop, close the shutoff valve and consult with TOTO Service (→see contact information on the back cover).</p>
The main unit is unstable	<p>There is clearance between the toilet seat cushion and the bowl unit for activating the seat switch. When you sit on the toilet seat, the toilet seat subsides slightly to activate the seat switch. (→Page 11)</p>

*1 Except TCF34170GEU, TCF34120GEU and TCF34120GGB.

The main unit makes a sound
When sitting on the toilet seat

You may hear the sound of water being warmed up.

When "Pre-mist" is "ON", you hear operation sounds for preparing the pre-mist or spraying mist in the bowl unit.^{*1} (→Page 20)

▶ You can turn it "OFF". (→Page 30)

When the toilet is occupied

You hear an operation sound at intervals of a few seconds when the cleansing functions are working properly.

When moving away from the bowl unit after use

If "Auto wand CLEAN" is "ON" and you use the cleansing functions (e.g., Rear cleansing and Front cleansing), you may hear that the wand is extended and cleaned with "EWATER+". (→Page 20)

▶ You can turn it "OFF". (→Page 30)

You may hear the sound of the remaining water being drained.

You may hear the fan ventilating the unit. (About 30 minutes)

For TCF34270GEU

When "Auto power deodorizer" is "ON", operation sounds are made while the deodorizing power increases for 60 seconds after you stand up from the toilet seat. (→Page 20)

▶ You can turn it "OFF". (→Page 31)

When not using the product (e.g., at night)

If "Auto wand CLEAN" is "ON" and you do not use the cleansing functions (e.g., Rear cleansing and Front cleansing) for about 8 hours, you will hear that the wand is cleaned with "EWATER+" and then the remaining water is drained from inside the product.

▶ You can turn it "OFF". (→Page 30)

You feel air in the toilet bowl when sitting on the toilet seat^{*1}

A mist is sprayed inside the toilet bowl to make it more difficult for dirt to adhere when sitting on the toilet seat. You may feel air when a mist is sprayed. (→Page 20)

▶ You can turn it "OFF". (→Page 30)

"Power" LED (orange) and "Energy saver" LED (orange) on product main body are flashing

If the "Power" LED (orange) and "Energy saver" LED (orange) flash at the same time, it is time to perform the Descaling mode.

▶ Perform Descaling mode. (→Page 41)

The main unit cannot be operated through the remote control

Follow the instructions "Please check first (A–C)". (→Page 53)

The following conditions may affect the reception performance of the remote control, resulting in not being able to operate the main unit.

- When the room size, the layout of fixtures etc. interfere
 - When the color of the ceiling or walls is too dark, or their shape or material interfere
 - When there is a rack or cabinet installed on the wall behind the main unit
 - When an inverter lighting system is used
- ▶ Change the position of the remote control and try again.

Specifications

Item	TCF34270GEU	TCF34170GEU	TCF34120GEU TCF34120GGB
Rated power supply	AC 220-240 V AC, 50 Hz		
Rated power consumption	843-853 W	841-852 W	
Maximum power consumption	1482-1495 W <When the water supply temperature is 0 °C>	1480-1494 W <When the water supply temperature is 0 °C>	
Type of water heater	Instantaneous type		
Power cord length	0.9 m	1.2 m	
Water protection level	IPX4		
Cleansing			
Spray volume	Rear cleansing: Approx. 0.27-0.43 L/min. <at 0.20 MPa water pressure> Rear soft cleansing: Approx. 0.27-0.43 L/min. <at 0.20 MPa water pressure> Front cleansing: Approx. 0.29-0.43 L/min. <at 0.20 MPa water pressure>		
Water temperature	Adjustable temperature range: OFF, about 35-40 °C		
Heater capacity	1200-1428 W		
Safety device	Temperature fuse		
Backflow prevention device	Air gap (according to EN1717), Vacuum breaker		
Heated seat			
Surface temperature	Adjustable temperature range: OFF, about 28-36 °C (Auto energy saver: about 26 °C, Auto energy saver+: OFF)		
Heater capacity	55-65 W		
Safety device	Temperature fuse		
Deodorizer			
Method	O ₂ deodorization	-	
Airflow volume	Normal mode: Approx. 0.09 m ³ /min Power mode: Approx. 0.16 m ³ /min	-	
Power consumption	Normal mode: Approx. 1.5 W Power mode: Approx. 3.9 W	-	
Water supply pressure	Minimum required water pressure: 0.1 MPa <dynamic>, Maximum water pressure: 1.0 MPa <static>		
Water supply temperature	0-35 °C		
Working ambient temperature	0-40 °C		
Dimensions	W 383 mm x D 540 mm x H 130 mm		
Weight	About 5 kg		

Safety Guidelines

A warm-water cleaning toilet seat is an electric appliance.

Continued use after malfunction occurs or use when its life-time is expired may deteriorate the electric components, producing smoke or resulting in a fire.

For safe use of the warm-water cleaning toilet seat



If any abnormality of the product is observed, stop using it and consult the installer, seller or the contact listed on the back cover of this manual.

(A damaged product may cause a fire, electric shock, or may flood the floors with water.)

- Turn off the power immediately and close the shutoff valve.

Warranty

MANUFACTURER'S GUARANTEE OF TOTO EUROPE GMBH

1. The guarantee of TOTO Europe GmbH

TOTO Europe GmbH (hereinafter referred to as "TOTO") provides a guarantee such that the products it markets shall be free of manufacturing errors in the case of normal use and service for a period of two years from the date of purchase. This guarantee only applies to ultimate consumers.

"Ultimate consumer" within the meaning of this guarantee is any natural person who has entered into a legal transaction for a purpose that can neither be attributable to their commercial nor professional activity and who does not wish to sell the product to other parties.

This guarantee does not affect the ultimate consumer's contractual or statutory rights in dealings with the affected seller and the statutory rights of the ultimate consumer in dealings with the product manufacturer.

Performed repairs that were authorised by TOTO, or any exchange of products or product parts, shall not lead to an extension of the guarantee period and furthermore shall not lead to the guarantee period starting afresh including insofar as these guarantee conditions are included with the substitute product.

2. Guarantee

TOTO provides a guarantee such that the TOTO products are free of manufacturing errors. The assessment whether or not a product is faulty is based on the level of technology at the time of manufacture.

TOTO's obligations in accordance with this guarantee are limited, at TOTO's discretion, to the repair or replacement of products or product parts that are considered faulty by TOTO on condition that such products were installed and used in accordance with the instructions for use issued in conjunction with the product and in compliance with all acknowledged demands placed on professional installation. TOTO reserves the right to conduct such investigations that appear necessary to establish the cause of the fault. TOTO shall not charge the ultimate consumer for the cost of the repair, the products or parts of products as part of repairs covered by the guarantee or products that are replaced under the guarantee.

3. Preconditions to be met to activate the guarantee

The invoice must be made available to TOTO, for example as a copy, stating the date of purchase, the invoice number, name and address of the ultimate consumer as well as the name and address of the seller for a guarantee claim to be valid. TOTO may request that the ultimate consumer provide photographs that either illustrate the damage and/or the type of connections to the power network or to the fresh and industrial water supply lines. Insofar as TOTO requests this, such photographs must also be presented to render the guarantee valid. A claim based on this guarantee takes for granted that the products for which notification of defects has been provided were installed and used properly and in accordance with the

instructions, which TOTO includes in the product delivery, and in this respect the corresponding laws and other legal provisions have been complied with.

If the ultimate consumer claims that the purchased product is faulty, in the event of purchase from an installer, the ultimate consumer is to contact such an installer. In all other cases, the ultimate consumer may contact his/her respective seller or a Service Center authorised by TOTO or contact TOTO itself. Notification of the defect is to be given within a reasonable short period once the defect is identified, at the latest however before the guarantee expires.

4. Guarantee exclusion

This guarantee does not apply to the following points:

- a) Damage or loss as a result of fire, earthquake, flood, storm or other cases of force majeure, emissions, gas damage (hydrogen sulphide), damage caused by salt or abnormal voltage,
- b) Damage or loss as a result of installation not in accordance with the conditions for use or not in accordance with acknowledged demands placed on professional installation; improper, wrong or inappropriate use or failure to follow the TOTO conditions for use or labels on the product or inappropriate product maintenance contrary to the conditions for use,
- c) Damage or loss as a result of altering, dismantling or destroying the product,
- d) Damage or loss as a result of sedimentation or foreign bodies in the water system,
- e) Damage or loss as a result of the water quality in the region in which the product is used,
- f) Damage or loss as a result of relocation following installation or due to a detrimental environment,
- g) Damage or loss caused by circumstances that do not involve the product itself, for example as a result of intervention in the building structure,
- h) Damage or loss caused by bites from animals or insects such as mice or residues of dead animals or insects,
- i) Damage or loss as a result of freezing the product,
- j) Damage or loss as a result of improper energy supply, which in terms of the voltage, frequency or safety fuses does not comply with the regulatory requirements for power supply in a household or electro-magnetic waves that are caused outside the product such as power lines and peripheral devices,
- k) Damage or loss as a result of attaching the product in moving vehicles such as cars and ships,
- l) Damage or loss as a result of using batteries etc.,
- m) Damage or loss as a result of wear-and-tear of items subject to day-to-day servicing (e.g. deodorizing filter, water drain plug),
- n) If spare parts other than original TOTO spare parts are used during repairs or maintenance of the product,
- o) The fault was caused by the transportation or installation of the product,

- p) The product is a demonstration product/viewing product/former demonstration product/former viewing product,
- q) If consumables (e.g. filters, filter cartridges or batteries) or materials subject to customary wear-and-tear (such as seals or hoses) are affected,
- r) If the fault was caused by the breakage of brittle parts (e.g. sensor windows or small flaps),
- s) If the fault is attributable to the fact that the product damage was caused intentionally or gross negligently by the ultimate consumer or a third party.

SPECIAL, OR CONSEQUENTIAL DAMAGE OR EXPENSES INCURRED BY PURCHASER, OR FOR LABOR OR OTHER COSTS DUE TO INSTALLATION OR REMOVAL, OR COSTS OF REPAIRS BY OTHERS, OR FOR ANY OTHER EXPENSE NOT SPECIFICALLY STATED ABOVE.

TOTO Europe GmbH
Zollhof 2 40221 Düsseldorf Germany

In each individual case, TOTO shall assess whether or not the ultimate consumer has a guarantee claim. If TOTO considers the asserted claim to be justified, and examines the affected product for that reason and thereupon it becomes clear that the product was not faulty or a guarantee claim did not apply, TOTO reserves the right to invoice the ultimate consumer for the costs that arise as a result of a visit by TOTO, or a company commissioned by TOTO, to the ultimate consumer and as a result of the rendered or intended services. If the ultimate consumer can furnish proof that the ultimate consumer could not have been aware that the preconditions for a claim were not met, TOTO shall not invoice the ultimate consumer for its visit to the ultimate consumer and the rendered or intended services. In the event that TOTO does not rectify the defect based on the guarantee, TOTO shall invoice the ultimate consumer for the costs that are actually incurred (material, labour and travelling).

In the event that the ultimate consumer holds the view that he/she has additional claims as a result of other guarantees, the ultimate consumer is to establish the probable validity of its claim and TOTO shall review such claims.

5. Geographical scope of the guarantee

The geographical scope of the guarantee differs depending on the product. The guarantee for TCF*****GEU is valid exclusively in the European Union and in Switzerland. The guarantee for TCF*****GGB is valid exclusively in the UK. If a product is installed in a geographical location in which TOTO neither has a marketing company nor a distribution partner, in respect of reviewing the guarantee activating event the ultimate consumer is to propose an installation company that satisfies comparable quality requirements.

6. Applicable law

This guarantee is subject to the law of the Federal Republic of Germany with the exception of the requirements on application of international private law and the UN Sales Law.

THIS WRITTEN WARRANTY IS THE ONLY WARRANTY MADE BY TOTO.

REPAIR OR REPLACEMENT AS PROVIDED UNDER THIS WARRANTY SHALL BE THE EXCLUSIVE REMEDY AVAILABLE TO THE ULTIMATE CONSUMERS.

TOTO SHALL NOT BE RESPONSIBLE FOR LOSS OF USE OF THE PRODUCT OR FOR OTHER INCIDENTAL,

Important User Guidance Information



If you want to dispose this product, do not mix it with general household waste.

Dispose of this product properly according to laws and regulations in your country.

Disposed of used batteries properly.

Do not dispose of them together with general household waste.

TOTO

Head Office

TOTO Europe GmbH
Zollhof 2, 40221 Düsseldorf Germany
Tel:+49 (0)700 8686 0700
E-Mail: teu.information@toto.com

You are advised to record the following information to allow quick service.

Date of purchase :	Name of shop :
Date : year month day	Tel :