



(6/3L) 100168869\_N386000054 

(4.5/3L) 100253638\_N386000088

**noken**  
PORCELANOSA BATHROOMS

Carretera CV-20 km.2 · 12540 Vila-real · Castellón · Spain  
Tel: +34 964 50 64 50 - Fax: +34 964 50 67 93  
e-mail: [noken@noken.com](mailto:noken@noken.com) · [www.noken.com](http://www.noken.com)

Elementos empotrados  
**Smart Line**



Lea atentamente estas instrucciones antes de comenzar la instalación.

- Compruebe el producto por si faltasen piezas o estuviesen dañadas.
- Cualquier alteración que se realice al sanitario invalidaría la garantía.
- Le recomendamos la instalación por parte de personal cualificado.
- En nuevas construcciones se deben llenar los sifones de inodoros, lavabos y bidets de agua para evitar que la grifería y los asientos se oxiden o amarilleen por el efecto de la subida de gases corrosivos. Se recomienda que el espacio esté muy aireado.
- Purgar las tuberías antes de la instalación.
- Compruebe el funcionamiento del mecanismo de la cisterna del inodoro.
- Gracias a un cuidado periódico se puede evitar la formación de restos calcáreos.
- Residuos de productos de aseo y limpieza pueden dañar las piezas metálicas, cromadas y/o de vidrio de los sanitarios, como bisagras, embellecedores, pulsadores, etc...

Please read these instructions carefully before starting installation and retain for future reference. Please leave these instructions with the end user.

- Remove all packaging and check the product for missing parts and damages before starting the installation.
- Any alterations made to this product and its fittings may infringe the water regulations and will invalidate the guarantee.
- We strongly recommend the use of a qualified and registered plumber.
- In new buildings it is recommended to water fill the traps to ensure toxic gases do not corrode the surface of the taps and toilet seats. It is recommended that the room is well ventilated.
- Thoroughly flush through all pipe work prior to the installation of terminal appliances, e.g. Shower heads, taps, inlet valves etc.
- Factory fitted components such as inlet and outlet valves should be checked for position and tightness, they may have loosened in transit. Check the operation of the valves.
- Periodic cleaning and maintenance should be used to avoid the build up of damaging lime scale deposits.
- Bathroom harsh cleaning agent residuals may damage components made of metal, glass and/or chromed parts such as, seat hinges, trim plates, push buttons, etc...

Lire attentivement cette notice avant de commencer l'installation

- Vérifier si certaines pièces sont manquantes ou abîmées.
- Toute altération causée au produit invalidera la garantie.
- Nous recommandons fortement l'installation du produit par du personnel qualifié.
- Dans le cas de constructions neuves, il faut mettre en eau les WC, lavabos et bidets pour éviter que la robinetterie et les abatants ne s'oxydent ou ne jaunissent à cause de gaz corrosif. Nous recommandons de bien ventiler la pièce.
- Purger les tuyauteries avant l'installation.
- Vérifier le fonctionnement du mécanisme du réservoir du WC.
- Grâce à un entretien régulier, on peut éviter la formation de calcaire.
- Les résidus de produits de nettoyage peuvent abîmer les pièces métalliques, en verre et/ou chromée des sanitaires, comme les charnières, enjoliveurs, boutons poussoirs, etc...

Leia atentamente as instruções antes de começar a instalação.

- Verifique se o produto se encontra em bom estado.
- Qualquer alteração que se realize no sanitário perde a garantia.
- Aconselhamos que a instalação seja feita por um profissional qualificado.
- Em novas construções, após a colocação da sanita, bidé e lavatório, os sifões deverão ser preenchidos com água para evitar o aparecimento de oxidações nas torneiras e tampas de sanita pelo efeito da subida de gases corrosivos pelos tubos.
- Recomenda-se que o espaço esteja muito arejado.
- Testar a tubaria antes da instalação.
- Testar o funcionamento do mecanismo do tanque de descarga da sanita.
- Mantendo um cuidado periódico poderá evitar a formação de calcários.
- Resíduos de produtos de limpeza podem danificar as peças de metal, cromado ou vidro de sanitários, tais como dobradiças, embelezadores, botões, etc...



	NF (6/3L) 100168869_N386000054 (4.5/3L) 100253638_N386000088
1	100148070_N499817038
2	100109751_N399999834
3	100109785_N499816957
4	100109779_N499816955
5	100180359_N499817087
6	100148071_N499817040
7	100170213_N449817082
8	100109763_N399999827
9	100109762_N399999828
10	100109760_N399999831
11	100180538_N299998837
12	100109755_N399999829
13	100109756_N399999832
14	100148049_N499817035
15	100180539_N499817091
16	100126997_N499816991
17	100180545_N299998839
18	100180546_N299998838
19	100180527_N499817089

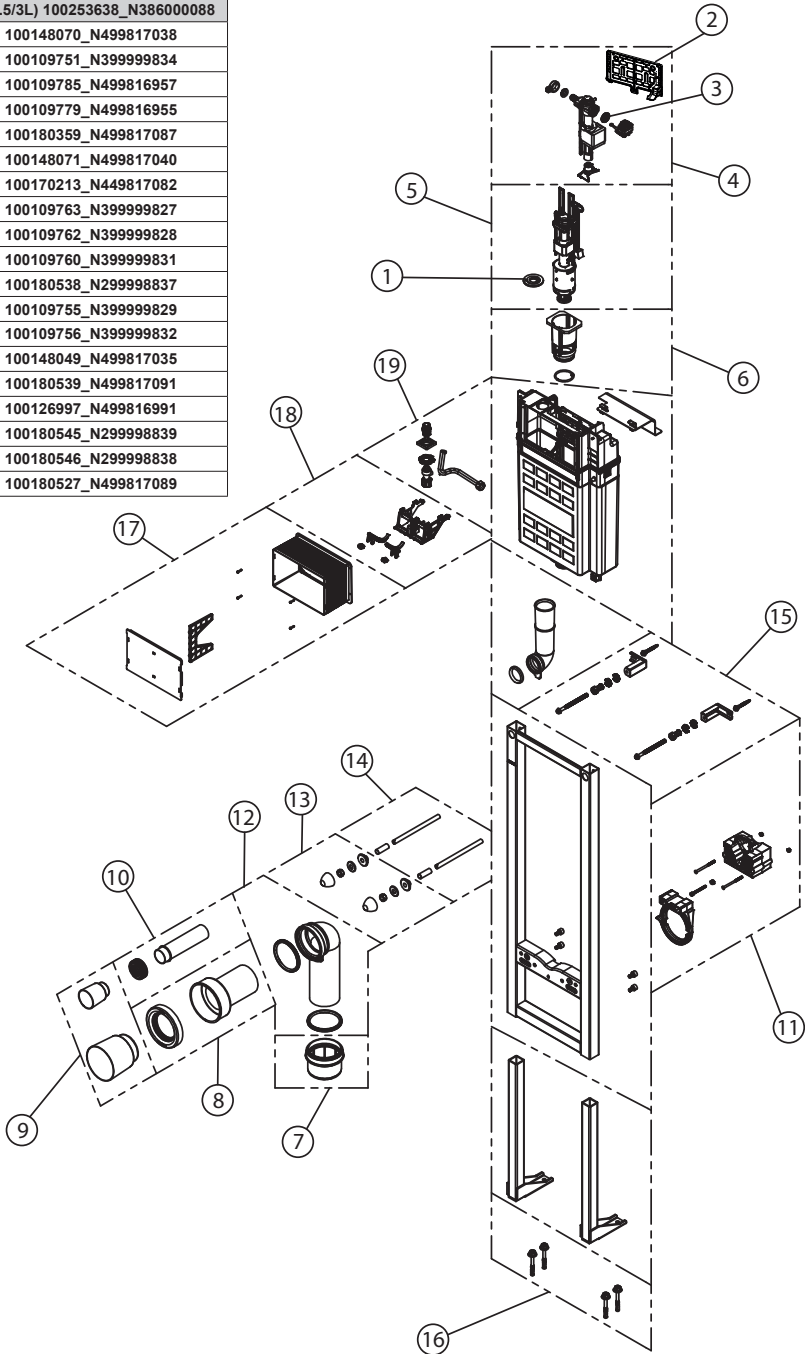

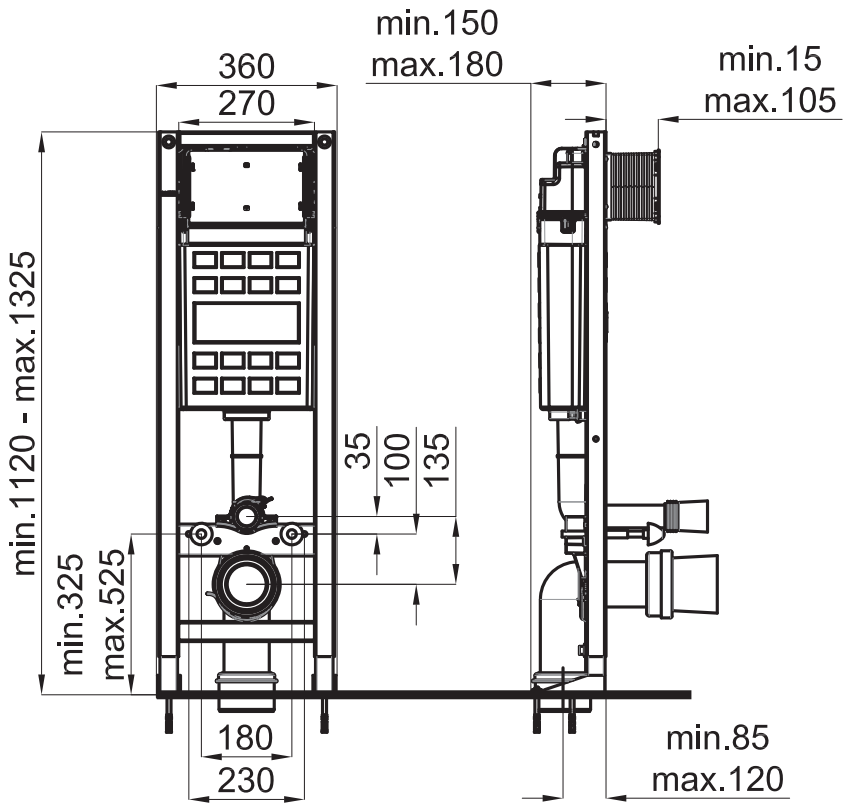
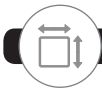



## Precauciones para la instalación

Consultar el manual de instrucciones y garantía antes de la instalación. Los puntos excluidos de la garantía se deben leer atentamente.

- Utilizar filtros en el agua de red.
- La instalación debe hacerse de acuerdo con la guía de instalación.
- Utilizar los tapones de protección hasta terminar la instalación del inodoro.
- La suciedad de la construcción puede causar problemas para los productos.
- Antes de instalar la cisterna/bastidor, la distancia entre fijaciones del wc (180 o 230 mm) tiene que ser comprobada.
- La altura de los espárragos de fijación del WC se deben ajustar según el plano del wc/bidet.
- Antes de alicatar la pared hay que verificar la cisterna y sus conexiones por si hubiesen fugas.
- La cisterna debe instalarse a nivel.
- Al instalarse el wc este debe conectarse a los tubos de unión. El wc no debe contacta con los espárragos metálicos.
- El tubo de alimentación de agua y el manguito de desagüe se deben cortar apropiadamente. Dejarlos más largos podría provocar problemas de fugas.
- Utilizar tacos y tornillería adecuada para paredes de ladrillo/cemento o ligeras.

## Installation precautions

The installation and User Guide, as well as the technical catalogue must be consulted before the installation. The points excluded from the warranty must be read carefully.

- Filter must be used in main supply.
- Installation must be done according to the installation and user guide.
- Dirt plugs must be used until installation is finished.
- Dirt from construction may cause problems for products.
- Before installing the concealed cistern please check the fixing bolt axis of the WC pan (180 or 230mm).
- Height of the WC pan fixing bolt axis must be adjusted according to the WC pan dimensions.
- Before tiling the wall the cistern and the connections have to be tested by water against leakage.
- The cistern must be installed on balance.
- While installing the bowl, the bowl must be fitted on plastic flanged bushings. The ceramic pan must not contact the metal bolts.
- The water inlet pipe and waste outlet pipe must be cut in proper dimension. Leaving the pipes longer may cause leakage problems.
- Appropriate anchor and screw must be used for brick or concrete wall or light.

## Précaution pour l'installation

Consulter le manuel d'instructions et garantie avant l'installation. Les points exclus de la garantie doivent être lu attentivement.

- Utiliser des filtres pour l'eau du réseau.
- L'installation doit être réalisée selon la notice de montage.
- Laisser les bouchons de protection en place jusqu'à la fin de l'habillage du bâti.
- La saleté des travaux peut causer des problèmes pour les produits.
- Avant d'installer le réservoir/bâti support, la distance entre fixations du WC (180 ou 230mm) doit être vérifiée.
- La hauteur des tiges filetéés de fixation du WC doit être ajustée selon le plan du WC/bidet.
- Avant de couvrir le mur vérifier que le réservoir et ses connexions dans le cas où il y aurait des fuites.
- Le réservoir doit être installé de niveau.
- En installant le WC, celui ci doit être connecté aux tubes raccords. Le WC ne doit pas être en contact avec les tiges filetéés métalliques
- Le tube d'alimentation en eau et le tube d'évacuation doivent être coupé correctement. Les laisser plus long pourrait provoquer des problèmes de fuites.
- Utiliser des chevilles et vis adaptés aux murs briques ou légers.

## Precauções de instalação

Consultar as instruções e o manual de garantia antes da instalação. Os pontos excluidos da garantia devem ser lidas cuidadosamente.

- Uso de filtros na rede de água
- A instalação deve estar de acordo com o guia de instalação.
- Use as tampas de protecção até terminar a instalação da sanita
- A suciedade da construção pode causar problemas para os produtos
- Antes de instalar o tanque/bastidor, a distância entre as fixações de wc (180 ou 230 mm) tem que ser verificado
- A altura dos pernos de fixação WC deve ser ajustado de acordo com o plano da sanita/bidet
- Antes de assentar azulejos na parede devem verificar o tanque e suas conexões se tinha fugas
- O tanque deve ser instalado o nível
- Al Instalar a sanitá deve ser ligado aos tubos de ligação. A sanita não deve contactar com os pernos de metal..
- o tubo de entrada de água e o tubo de drenagem deve ser cortada corretamente. Deixá-los por muito tempo podem causar fugas.
- Utilize buchas e parafusos apropriados para as paredes de tijolo ou ligeiras

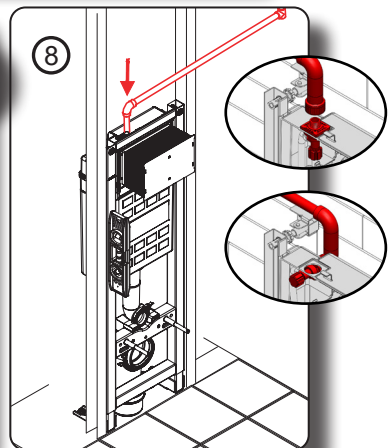
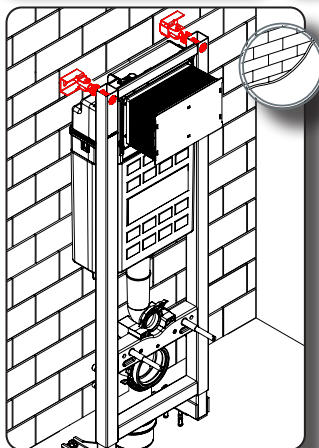
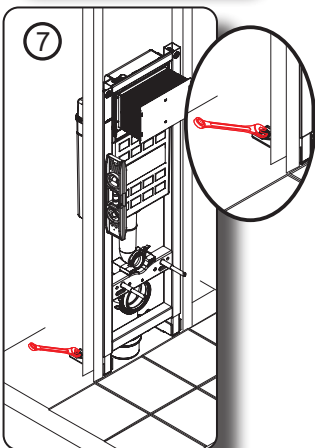
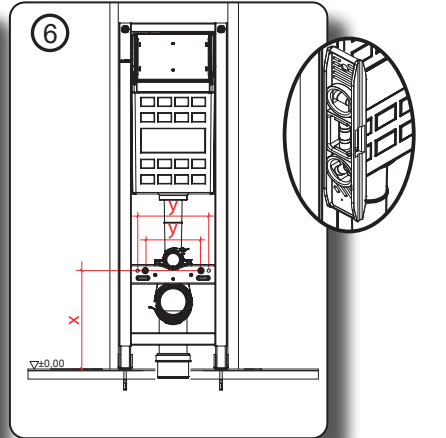
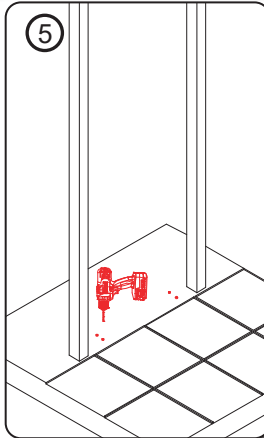
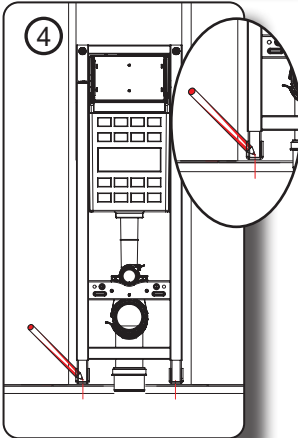
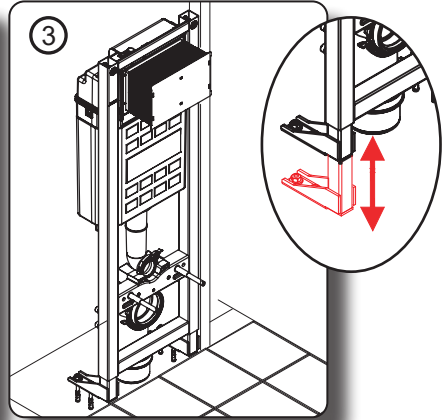
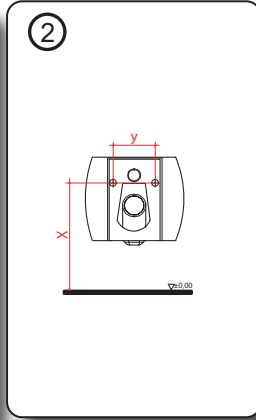
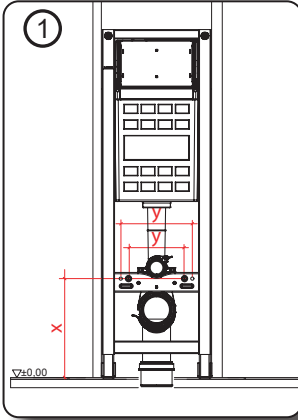

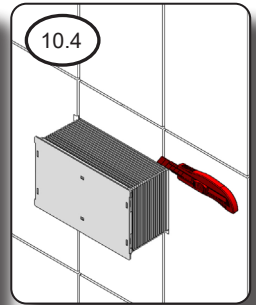
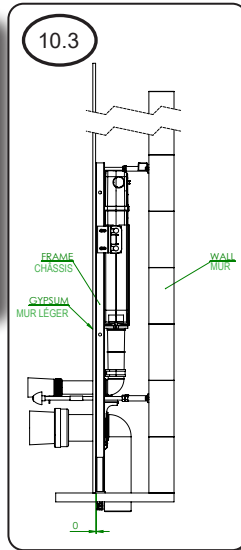
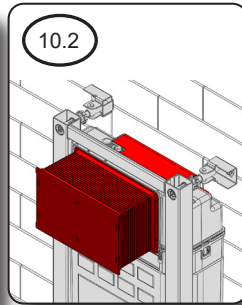
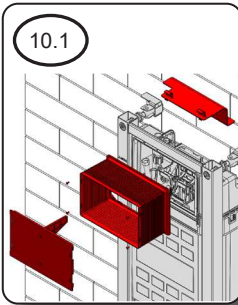
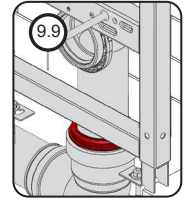
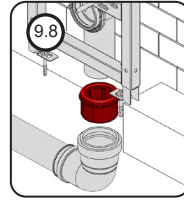
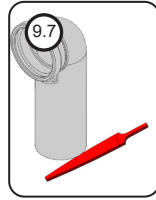
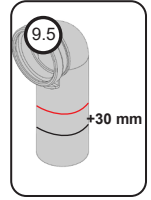
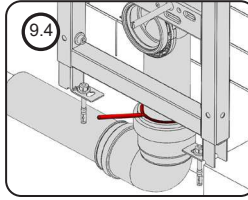
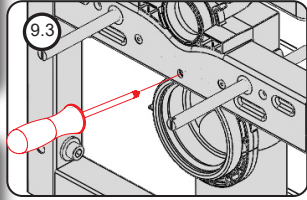
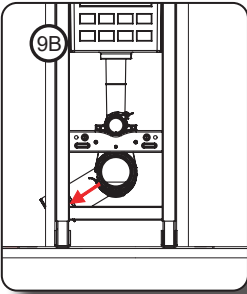
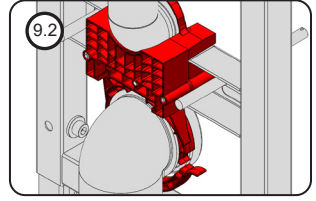
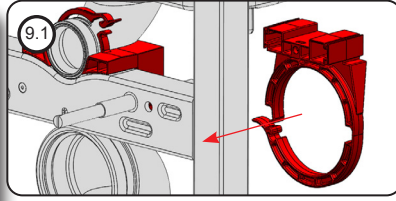
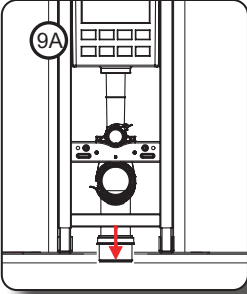

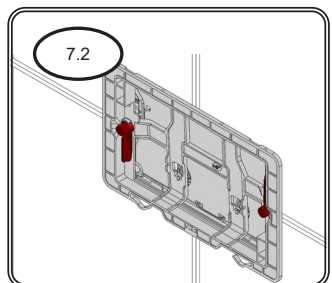
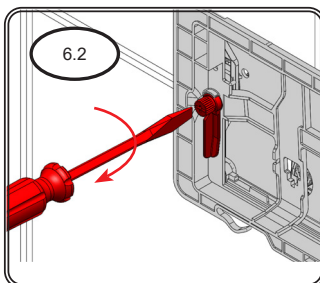
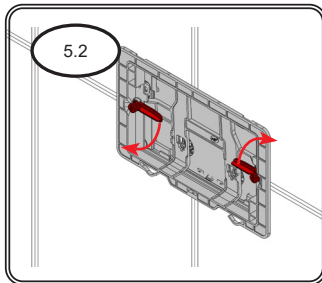
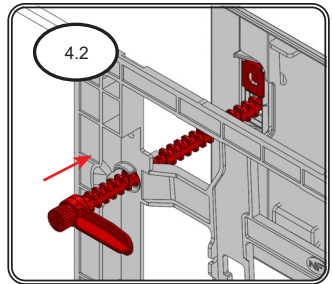
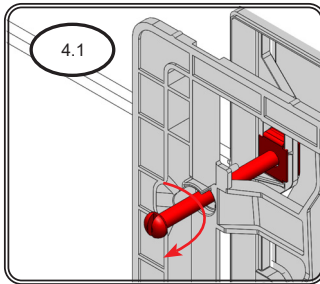
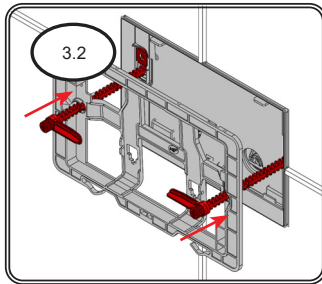
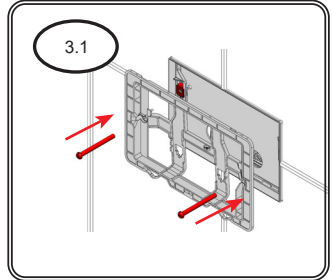
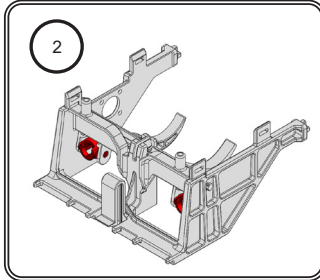
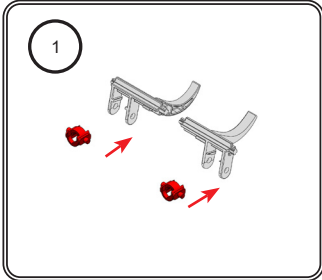
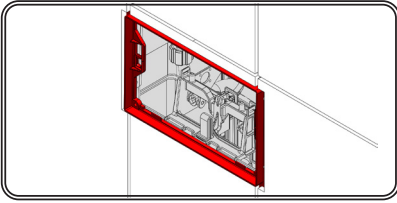



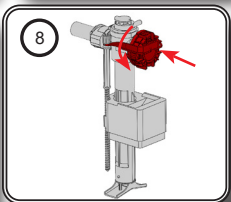
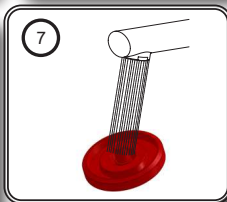
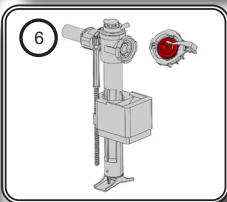
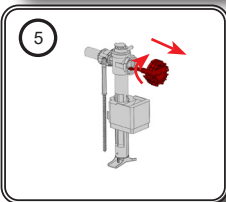
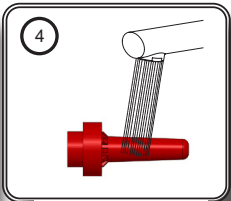
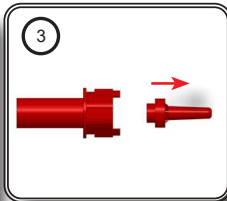
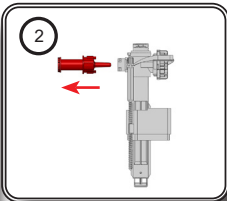
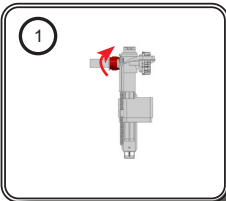
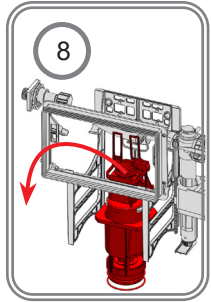
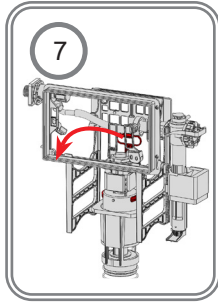
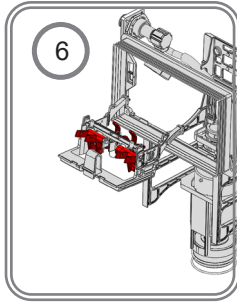
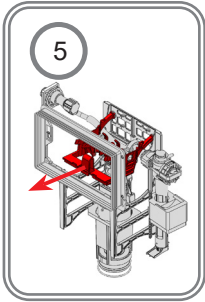
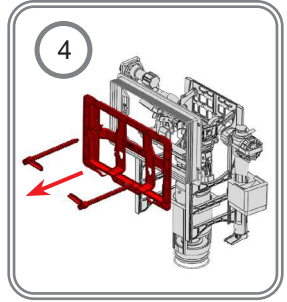
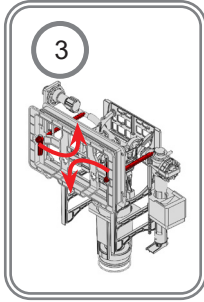
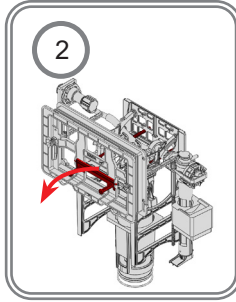
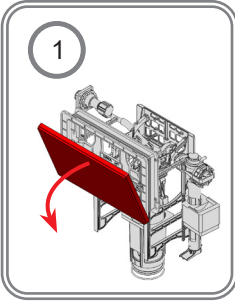

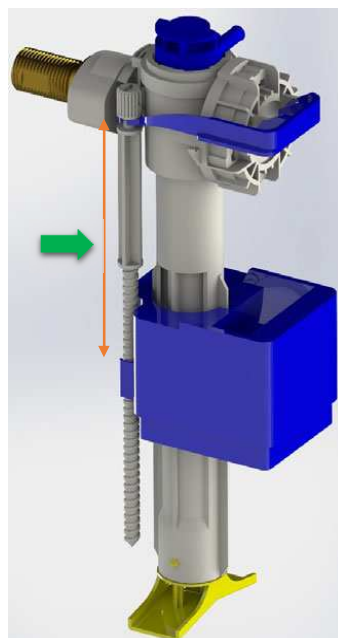
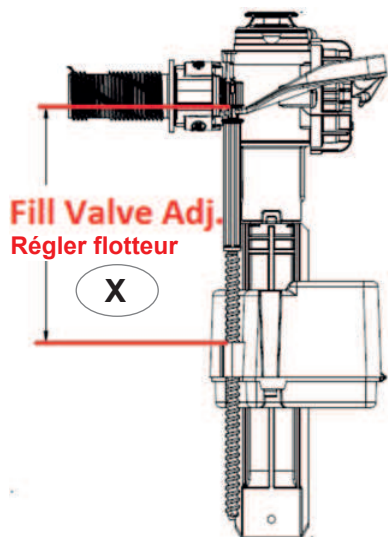



VOLUME	<b>X</b>
 <b>6/3L</b>	91 mm
<b>4.5/3L</b>	131 mm



**ADJUSTMENTS FOR FLUSH VALVE AND 747 FILL VALVE**  
**ADJUSTEMENTS POUR VALVE DE CHASSE ET ROBINET FLOTTEUR 747**

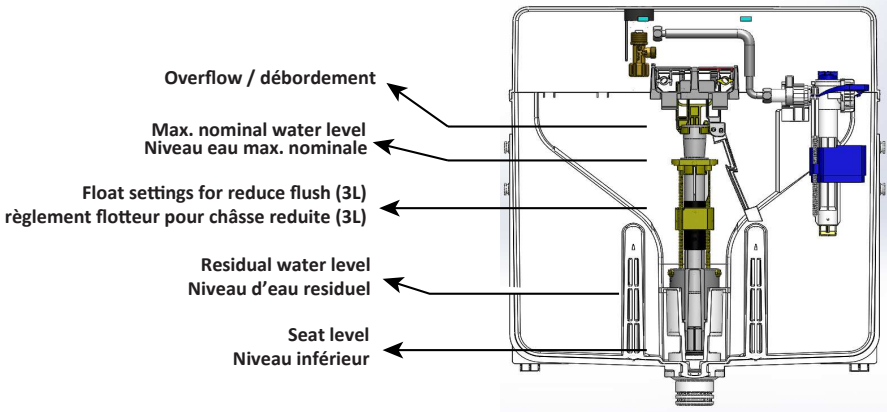

**Reduce flush adjustment for flush valve**  
**Règlement chasse pour chasse reduite**

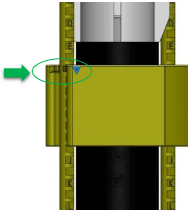

**Position A**

The triangle shown on the float should be in the upper position.  
 Le triangle indiqué sur le flotteur doit être en position supérieure

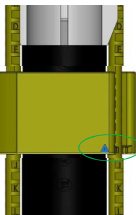

**Position B**

The triangle shown on the float should be in the down position.  
 Le triangle indiqué sur le flotteur doit être en position inférieure



-Adjusting rod letters  
 -Lettres de tige d'ajustement

VOLUME	POSITION	ROD LETTER
 <b>6/3L</b> <small>APPARELS SANITAIRES</small>	A	G
<b>4.5/3L</b>	B	N

## PORCELANOSA BATHROOMS



[www.noken.com](http://www.noken.com)

Para consultar la garantía u otra información relativa a este producto, visitar nuestra web:  
For a warranty or other information on this product, visit our Web address:  
Pour obtenir une garantie ou d'autres informations sur ce produit, visitez notre site web  
Para garantia ou outras informações sobre este produto, visite o nosso site

