

# TOTO

**TOTO U.S.A., Inc.** 1155 Southern Road Morrow, GA 30260  
Phone : (770) 282-8686

**Warranty Registration and Inquiry**

For product warranty registration, TOTO U.S.A. Inc. recommends On-Line Warranty Registration. Please visit our web site <http://www.totousa.com>. If you have questions regarding warranty policy or coverage, please contact TOTO U.S.A. Inc.,

Customer Service Department, 1155 Southern Road, Morrow, GA 30260 (888) 295 - 8134 or (678) 466 - 1300 when calling from outside of U.S.A.

- You are advised to record the following information to allow quick service.

Date of purchase :	Name of shop :
Date : year month day	Tel : (      )

# TOTO

Instruction Manual

## NEOREST AH · RH



### NEOREST

AH SN989M  
(MS989CUMFG)

RH SN988M  
(MS988CUMFG)



- Thank you for your recent purchase of this product.  
Please read the enclosed information to ensure the safe use of your product.
- Be sure to read this Instruction Manual before using your product and keep it in a safe place for future reference.

# What functions are available on your product?

Check your model name and write a check mark in this field as needed.



## Part number system

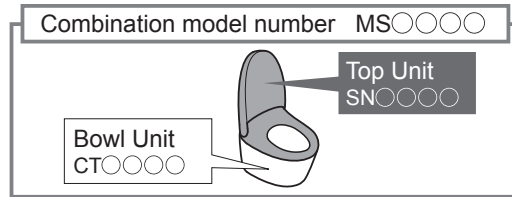

Product name (Model)			NEOREST		Ref. Page
			AH	RH	
Functions	Your Model	Part No.	SN989M	SN988M	
Basic Functions	Cleansing	Rear cleansing			18, 19
		Rear soft cleansing	●	●	
		Front cleansing			
		Wide front cleansing			
	Changing the cleansing method	Wand position adjustment			
		Water pressure adjustment			
		Oscillating cleansing	●	●	
		Pulsating cleansing			
		Personal setting lock			
	Drying	Warm air drying	●	●	
	Changing the temperature	Temperature adjustment	●	●	26, 27
Sanitary Functions	Removing odors	Deodorizer	●	●	22, 23
	"ewater+" sanitizing	Auto wand CLEAN	●	●	
		Auto bowl CLEAN	●	●	
Convenience Functions	Flushing	Remote control flushing	●	●	19
		Auto flushing			24, 25
	Opening and closing	Opening and closing the toilet seat with remote control	●	●	19
		Auto open / close			24, 25
	Lighting up	Soft light	●	●	
	Heating the toilet seat	Heated seat	●	●	-
	Save energy by lowering the toilet seat temperature	Auto energy saver			30, 31
		Auto energy saver+	●	●	
Timer energy saver					
Lower the bowl unit water level	Lower water level	●	●	54	
Maintenance		Bowl unit cleaning			34
		Cleaning lift			36
		Removable toilet lid	●	●	37
		Wand cleaning			38

# Keep It Clean Sanitary Toilet

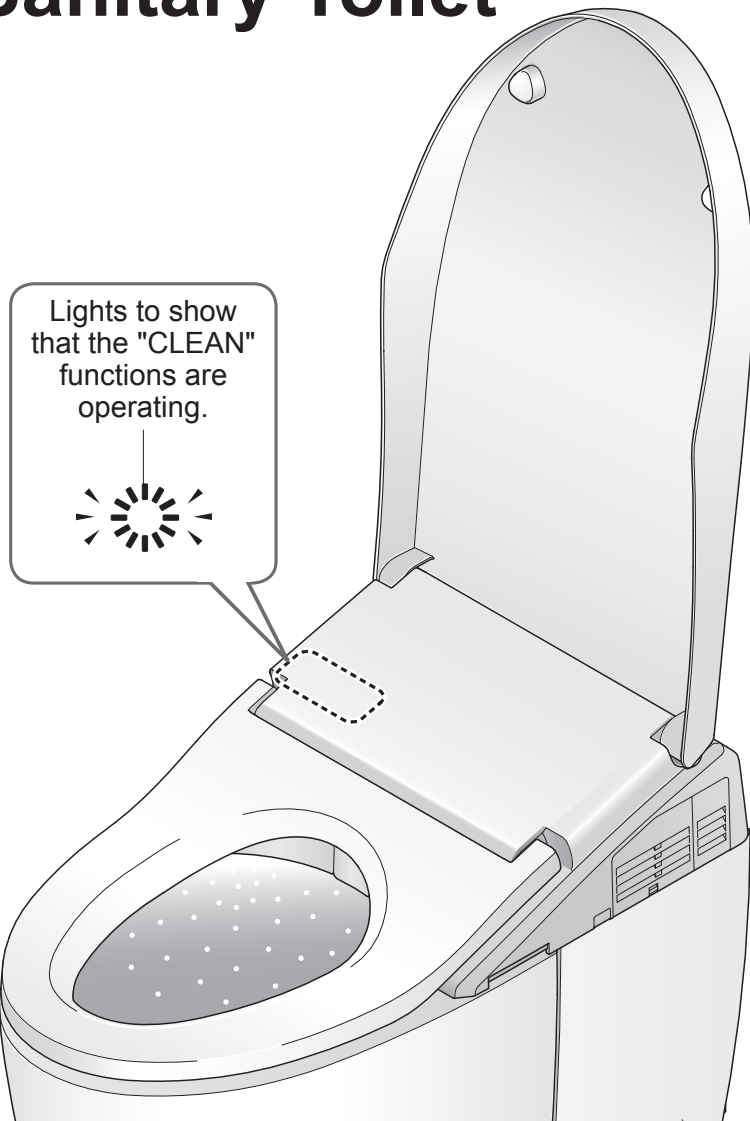

**The self-cleaning functions operate automatically.**  
(See pages 22 and 23 for details.)

	As you approach	As you sit	As you stand up
Removing odors inside the bowl unit.		Deodorizer	Auto power deodorizer
Sanitize the bowl unit with "ewater+"	Auto bowl CLEAN		Auto bowl CLEAN
Sanitize the wand with "ewater+"			Auto wand CLEAN



## Table of Contents

Safety Precautions.....	4	Introduction
Operational Precautions .....	11	
Parts Names.....	14	
Preparation .....	16	
Basic Operations.....	18	Operation
Automatic Functions (Cleaning Features).....	22	
Deodorizer, Auto wand CLEAN, Auto bowl CLEAN, Bowl light, CLEAN indicator		
Automatic Functions (Convenience Features) .....	24	
Auto flushing, Auto open/close, Soft light		
Temperature Adjustment (Toilet Seat, Warm Water, Drying)... ..	26	
Energy Saver Features .....	28	
Maintenance .....	32	Maintenance
● Power Plug .....	32	
● Top Unit.....	33	
● Bowl Unit.....	34	
Bowl unit cleaning		
● Deodorizing Filter.....	35	
● Gap between the Top Unit and Bowl Unit .....	36	
● Gap between the Top Unit and the Toilet Lid.....	37	
● Wand .....	38	
Wand cleaning		
● Water Filter Drain Valve .....	39	
● Water Filter (Bowl Unit).....	40	
Changing Settings .....	42	Reference
What to Do?.....	56	
● If the water does not flow due to a power outage.....	56	
● If the water does not flow due to a water service interruption.....	58	
● If you cannot operate with the remote control.....	58	
● Freeze Damage Prevention.....	59	
● Long Periods of Disuse.....	60	
● Removal of Operation Guide .....	62	
Troubleshooting.....	63	
Specifications .....	71	
Warranty.....	72	



# Safety Precautions

## IMPORTANT SAFEGUARDS READ ALL INSTRUCTIONS BEFORE USING



### Symbols and Meanings

	<b>WARNING</b> May result in death or serious injury.
	<b>CAUTION</b> May result in injury or property damage.

The following symbols are used to indicate important safety instructions for the use of the product.

Symbol	Meaning
	This symbol indicates a prohibited use of the product.
	This symbol is used to indicate a required step in the use of this product.

- This product is classified as Class 1 Equipment and must be grounded.
- Install this equipment where the electrical outlet is accessible.
- This appliance is not intended for use by persons (including children) with reduced physical, sensory or mental capabilities, or lack of experience and knowledge, unless they have been given supervision or instruction concerning use of the appliance by a person responsible for their safety. Children should be supervised to ensure that they do not play with the appliance.
- Use the new hose set included with this equipment. Do not reuse an old hose set.

 <b>WARNING</b>	
	<b>Do not plug or unplug the power plug with wet hands.</b> • Doing so may cause electrical shock.
	<b>Do not get any water or cleaning solution on the top unit or power plug.</b> • Doing so may cause fire, electrical shock, heat or short circuit. • Doing so may cause the product to crack resulting in injury or water damage.
	<b>Never disassemble, repair or alter.</b>
	<b>Do not use tools in places other than designated.</b> • Doing so may cause fire, electrical shock, overheating, short circuit or breakdown.
	<b>Do not install the product on moving vehicles such as wheeled vehicles or boats.</b> • Doing so may cause fire, electric shock, short circuit or malfunction. • The toilet seat, toilet lid, top unit or other parts may come loose and fall off, resulting in injury.



## WARNING

### **Do not use the product if a malfunction occurs.**

In case of breakdown or other problem, be sure to cut off power by means such as unplugging the power plug or switching the breaker in the distribution board to OFF.

Close the water shutoff valve to stop water supply.

Possible malfunctions:

- Water is leaking from a pipe or the top unit.
- The product is cracked or broken.
- The product makes a strange noise or emits a strange odor.
- The product emits smoke.
- The product is abnormally hot.
- The bowl unit is clogged.
- The toilet seat cushion is out of place.

- Continued use after malfunction could cause a fire, electric shock, heat, short circuit, injury or water damage.

### **Do not use other water than allowed by the laws and ordinances of the region of use.**

### **Only use drinking water. Do not use seawater or recycled water.**

- Doing so may cause irritation to the skin and malfunction.

### **Do not touch the power plug during thunderstorms.**

- Doing so may cause electrical shock.



### **Do not allow the water supply hose to touch the power plug or outlet.**

- Doing so may cause condensation resulting in a fire, electrical shock, heat or a short.

### **Do not do anything that may damage the power cord or power plug.**

**Do not strike, yank, twist, excessively bend, damage, alter, or heat the power cords. Also, do not place anything heavy on, bind or pinch the power cords.**

- Using a damaged power cord may result in a fire, electrical shock, heat or short.

### **Do not use a loose or faulty electrical outlet.**

- Doing so may cause fire or short circuit.

### **Do not use any outlet or wiring equipment beyond its specified rating.**

- Plugging too many plugs into the same outlet, for example using outlet splitters, can cause fire due to heat.

### **Do not use any power supply other than the one specified.**

#### **AC 120 V, 60 Hz**

- Doing so may cause fire or excessive heat.

### **Do not stick a finger or anything else into the warm air outlet.**

**Do not place anything on the warm air outlet or drape clothes over it.**

- Doing so may cause burns, electrical shock or malfunction.

### **Keep cigarettes and other open flames away from the product.**

- Failure to do so may cause fire.

# Safety Precautions (Continued)

## **WARNING**

### **Refrain from sitting on the seat for long periods.**

- It may cause low-temperature burns.  
To prevent the following persons from getting a moderate temperature burn during use, other person should turn off the toilet seat heater and set the dryer temperature to "Low".
  - Young children, the aged and other users unable to set the temperature appropriately themselves.
  - The ill, physically disabled and others who do not have freedom of movement.
  - Those using any medicines that cause drowsiness (sleeping or cold medicine), those who have been drinking heavily, anyone severely fatigued and anyone else liable to fall asleep.

**This is an electrical product. Do not install it anywhere water is likely to get on the product or anywhere with humidity high enough that water is likely to form on the surface of this product. When using the product in a bathroom, install a fan or ventilation port and ensure good air flow through the bathroom.**

- Failure to do so may cause fire or electrical shock.

### **Always connect the product to the cold water supply.**

- Connecting to hot water supply may result in burns and equipment damage.

### **Make sure that a properly grounded (3 prong) outlet has been installed.**

- Failure to install a grounded outlet could cause electrical shock in the event of a malfunction or short circuit.



### **Insert the power plug securely into the outlet.**

- Failure to do so may cause fire, heat or short circuit.

### **To unplug, hold the power plug, not the power cord.**

**Do not unplug by pulling the power cord.**

- Pulling on the power cord may cause damage and result in fire or heat.

**If the electric cord is damaged, avoid danger by having the manufacturer's repair department or equivalent specialist replace it.**

### **Always unplug the power plug from the outlet before maintenance or inspection.**

- Failure to do so may cause electrical shock or malfunction.

### **Periodically remove dust and dirt from the power plug and make sure it is securely plugged into the wall outlet.**

- Failure to do so may cause fire, heat or short circuit.  
Unplug the power plug from the outlet and wipe clean with a dry cloth.

### **When leaking battery fluid adheres to your body or clothes, wash it away with clean water.**

- The fluid may damage your eyes or skin.

## WARNING



**Preliminary studies in females suggest that overuse of continuous spraying can increase the possibility of vaginal mucosa drying and potential reduction in desirable microbial organisms.**

**Although these studies have not been validated, please consult your healthcare provider for concerns regarding whether these circumstances may apply to you.**

**More importantly, if you are an individual suffering from any immune deficiency as a result of disease, chemotherapy, or other medical condition compromising the immune system you should consult your healthcare provider before use of this product.**

## CAUTION



**Do not use the product if the top unit is unstable.**

- Doing so may cause the top unit to come loose and fall, resulting in injury.

**If the product is damaged, do not touch the damaged section.**

- Doing so may cause electrical shock or injury. Replace it immediately.

**Do not apply strong force, mechanical shock, step on or stand on the toilet seat, toilet lid or top unit. Also do not place any heavy object on the toilet seat, toilet lid or top unit.**

- Doing so could cause cracking or cause the top unit to come loose and fall, resulting in injury.
- Doing so could damage the product and cause injury or water damage.

**Do not lift up this product by the toilet seat or lid.**

**Do not raise the toilet seat or lid while objects are resting on top of the unit.**

- Doing so may cause the top unit to come loose and fall, resulting in injury.

**When maintaining the plastic parts (top unit etc.) or the water supply hose, use a neutral kitchen detergent diluted with water. Do not use any of the following.**

**Toilet cleaner, household cleaner, benzene, paint thinner, powdered cleanser or nylon scrubbing brush.**

- These items may damage or crack the plastic and cause injury or malfunction.
- These items could damage the water supply hose and cause a water leak.

**To prevent a sudden water leak, do not remove the water filter drain valve when the shutoff valve is open.**

- Doing so will cause water to spurt out.

(Refer to Page 39 for instructions on cleaning the water filter drain valve.)

**Do not fold or crush the water supply hose; do not damage by cutting with a sharp object.**

- Doing so may cause water leaks.

**Do not pour hot water into the toilet.**

- Doing so may result in damage to the toilet, injury or water damage.



**Do not flush anything other than bodily waste and toilet paper. Also, do not flush too much toilet paper.**

**Do not flush the bowl unit if it is clogged.**

- Doing so may clog the toilet, causing waste water overflow, and water damage.



# Safety Precautions (Continued)

 <b>CAUTION</b>	
	<p><b>Keep the bowl filled with water.</b></p> <ul style="list-style-type: none"> <li>• Failure to do so may cause sewer gas, chlorine gas, or hydrogen sulfide to corrode facilities and equipment.</li> </ul> <p><b>Do not use the product while the top unit is lifted up by the cleaning lift.</b></p> <p><b>When lowering the top unit by the cleaning lift, do not insert your fingers into the gap between the top unit and the bowl unit.</b></p>
	<p><b>If a water leak should occur, always close the shutoff valve.</b></p> <p><b>When the ambient temperature is likely to drop to 32°F (0°C) or lower, prevent damage to the pipes and hoses due to freezing.</b></p> <ul style="list-style-type: none"> <li>• Frozen water pipes could cause the top unit and the pipes to break, resulting in a water leak.</li> <li>• Regulate the room temperature to prevent the pipes and hoses from freezing during cold months.</li> </ul> <p><b>When not using the product for a long time, close the shutoff valve, drain the water from the top unit and water supply hose, and unplug the power plug from the outlet.</b></p> <ul style="list-style-type: none"> <li>• When using the product again, allow the product to refill with water first. Otherwise, the water in the tank might become contaminated and cause skin inflammation or other problems. (Refer to Page 61 for instructions on replenishing the water.)</li> <li>• Leaving the power on may cause fire or heat.</li> </ul> <p><b>When installing the water filter drain valve, make sure that it is securely tightened in its proper position.</b></p> <ul style="list-style-type: none"> <li>• Failure to securely tighten it may cause a water leak.</li> </ul> <p><b>If the bowl unit is clogged, unplug the power plug and remove the clog.</b></p> <ul style="list-style-type: none"> <li>• If the auto flush were allowed to function, it would make the wastewater in the bowl unit overflow and may result in water damage.</li> <li>• Use commercially available tools that are made for unclogging the bowl unit to remove the clogging.</li> </ul> <p><b>Always flush, even after just urinating.</b></p> <ul style="list-style-type: none"> <li>• Failure to do so may clog the toilet, causing waste water overflow and water damage or inadequate flushing of the bowl unit.</li> </ul> <p><b>Wipe condensation on the bowl unit, tank, water supply pipe and shutoff valve with a dry cloth.</b></p> <ul style="list-style-type: none"> <li>• Condensation may cause staining and corrosion of the floor.</li> <li>• Ventilate the restroom to prevent condensation.</li> </ul> <p><b>Wipe any urine, condensation, cleaner, water, etc. that has gotten on the floor with a well-wrung mop or cloth.</b></p> <ul style="list-style-type: none"> <li>• Failure to do so may cause staining and corrosion of the floor.</li> </ul> <p><b>Make sure of the plus and minus signs on the batteries before inserting them. Remove depleted batteries immediately.</b></p> <p><b>When replacing the batteries:</b></p> <ul style="list-style-type: none"> <li>• <b>Replace both batteries with new ones.</b></li> <li>• <b>Use the same brand for both new batteries (any brand available).</b></li> <li>• Failure to do so may cause the batteries to leak fluid, generate heat, rupture, or ignite.</li> </ul> <p><b>When the product is supposed not to be used for long time, remove the batteries from the remote control and battery box.</b></p> <ul style="list-style-type: none"> <li>• Failure to do so may cause the batteries to leak fluid.</li> </ul>

 **DANGER** To reduce the risk of electrocution:

1. Do not use while bathing.
2. Do not place or store the product where it can fall or be pulled into a tub or sink.
3. Do not place in or drop into water or other liquid.
4. Do not reach for the product when it has fallen into water. Unplug it immediately.

 **WARNING** To reduce the risk of burns, electrocution, fire or injury to persons:

1. Close supervision is necessary when this product is used by, on, or near children or invalids.
2. Use this product only for its intended use as described in this manual. Do not use attachments not recommended by the manufacturer.
3. Never operate this product if it has a damaged cord or plug, is not working properly, has been dropped or damaged, or has been dropped in water. Return the product to a service center for examination and repair.
4. Keep the cord away from heated surfaces.
5. Never block the air openings on the product or place it on a soft surface, such as a bed or couch, where the air openings may be blocked. Keep the air openings free of lint, hair, and other similar items.
6. Never use while sleepy or drowsy.
7. Never drop or insert any object into any opening or hose.
8. Do not use outdoors. Do not operate where aerosol (spray) products are being used or where oxygen is being administered.
9. Connect this product to a properly grounded outlet only.  
See "Grounding Instructions" in Page 10.
10. The tank should be filled with water only.

- Servicing should be performed by an authorized service representative.
- This product is for household use.

# Safety Precautions (Continued)

## Grounding Instructions

This product should be grounded. In the event of an electrical short circuit, grounding reduces the risk of electric shock by providing an escape wire for the electrical current.

The plug must be plugged into an outlet that is properly installed and grounded.

 **DANGER** - Improper use of the grounding plug can result in a risk of electric shock.

If repair or replacement of the cord or plug is necessary, do not connect the grounding wire to either flat-head terminal.

Check with a qualified electrician or serviceman if the grounding wire instructions are not completely understood, or if in doubt as to whether the product is properly grounded.

This product is factory equipped with a specific electric cord and plug to permit connection to a proper electric circuit. Make sure that the product is connected to an outlet having the same configuration as the plug.

No adapter should be used with this product. Do not modify the plug provided - if it will not fit in the outlet, have the proper outlet installed by a qualified electrician.

If the product must be reconnected for use on a different type of electric circuit, the reconnection should be made by qualified service personnel.

If it is necessary to use an extension cord, use only a three wire extension cord that has a three blade grounding plug, and a three-slot receptacle outlet that will accept the plug on the product.

Replace or repair a damaged cord.

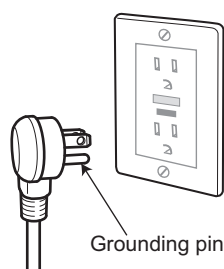

**SAVE THESE INSTRUCTIONS**

# Operational Precautions

## ■ About the seat switch

● When you sit on the toilet seat, the seat switch turns ON, enabling you to use various features. (A click sound is heard when the seat switch is ACTIVATED.)

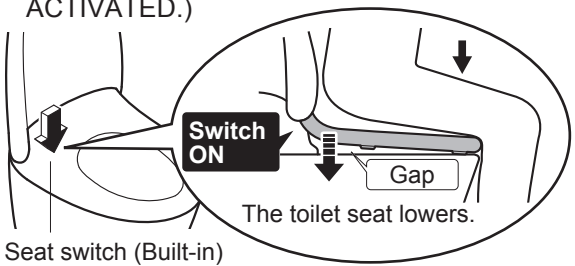

Seat switch (Built-in)

● Sit back on the toilet seat.  
The seat switch will not turn on unless you sit on the seat properly.

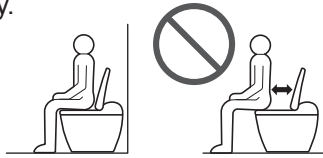

**Note**

- When a child uses the product, the seat switch may not be ACTIVATED by their light body weight.
- Since the toilet seat is designed to move up and down, a clearance is provided between the toilet seat cushion and the bowl unit.

## ■ For prevention of damage

- Wipe plastic areas such as the top unit and remote control with a soft cloth tightly wrung out with water.

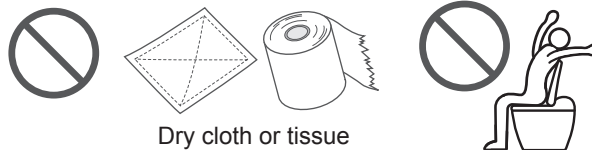

- Do not lean against the toilet lid.

## ■ For prevention of malfunctions and failures

- Do not block the remote control transmitter or receiver.  
(May cause top unit to malfunction)
- Unplug the power plug if there is a risk of lightning.
- A toilet seat cover or a toilet lid cover cannot be used.  
(The seat switch may not function properly. Additionally, the toilet seat and lid may not open or close properly.)
- Do not urinate on the top unit, toilet seat or wand.  
(Doing so may cause a failure or discoloration.)
- Do not apply strong forces to the control panel of the remote control.
- When using a toilet cleaner to clean the toilet, wash it off within 3 minutes and leave the toilet seat and toilet lid open.
  - Wipe off any cleaner that remains on the bowl unit.  
(If vapor from a toilet cleaner enters the top unit, it may cause a malfunction.)
- Do not use the product with the toilet lid removed.
- Do not expose to direct sunlight.  
(Doing so may cause changes in color, irregular heated seat temperature, or operation failure of the remote control.)
- Use radios, etc. away from product.  
(The product could cause interference with the radio signal.)
- If you use a booster seat for infants or a soft highchair, remove it after use.  
(Keeping it installed may prevent some of the functions from being used.)
- Do not apply force to the remote control.  
(May cause malfunctions.)  
To prevent the remote control from being dropped, set it in the hanger when you are not using it. Be careful not to expose it to water.
- Do not place anything on the toilet seat and lid, and do not press them with hands.  
(Failure to do so may turn on the seat switch, causing the floor to get wet if buttons on the remote control are touched and warm water comes out from the wand.)

# Operational Precautions (Continued)

## ■ Body Sensor Compliance

### ● FEDERAL COMMUNICATIONS COMMISSION (FCC) INTERFERENCE STATEMENT

This equipment has been tested and found to comply with the limits for a Class B digital device, pursuant to part 15 of the FCC Rules. These limits are designed to provide reasonable protection against harmful interference in a residential installation. This equipment generates, uses and can radiate radio frequency energy and, if not installed and used in accordance with the instructions, may cause harmful interference to radio communications.

However, there is no guarantee that interference will not occur in a particular installation. If this equipment does cause harmful interference to radio or television reception, which can be determined by turning the equipment off and on, the user is encouraged to try to correct the interference by one or more of the following measures:

- Reorient or relocate the receiving antenna.
- Increase the separation between the equipment and receiver.
- Connect the equipment into an outlet on a circuit different from that to which the receiver is connected.
- Consult the dealer or an experienced radio/TV technician for help.

### CAUTION:

Any changes or modifications not expressly approved by the grantee of this device could void the user's authority to operate the equipment.

This device complies with part 15 of the FCC Rules.

Operation is subject to the following two conditions:

- (1) this device may not cause harmful interference, and
- (2) this device must accept any interference received, including interference that may cause undesired operation.

### RF exposure warning

This equipment complies with FCC RF exposure limits set forth for an uncontrolled environment. This equipment must not be co-located or operating in conjunction with any other antenna or transmitter.

## ● Canada, Industry Canada (IC) Notices

This device complies with Industry Canada's licenceexempt RSSs.

Operation is subject to the following two conditions:

- (1) This device may not cause interference; and
- (2) This device must accept any interference, including interference that may cause undesired operation of the device.

### Radio Frequency (RF) Exposure Information

The radiated output power of the Wireless Device is below the Industry Canada (IC) radio frequency exposure limits.

The Wireless Device should be used in such a manner such that the potential for human contact during normal operation is minimized.

This device has also been evaluated and shown compliant with the IC RF Exposure limits under portable exposure conditions.

(antennas are less than 8 inch (20 cm) of a person's body).



# Parts Names

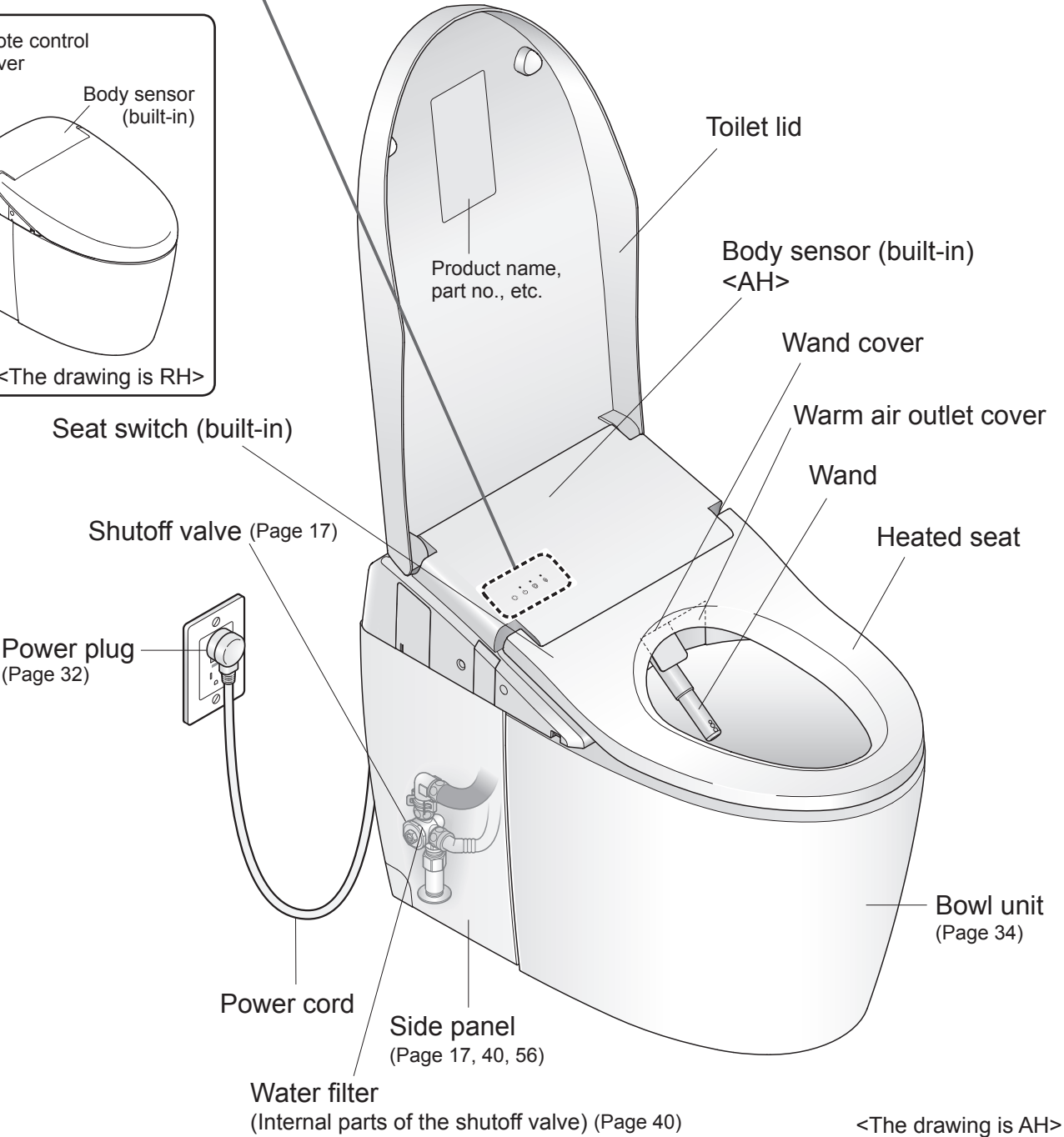
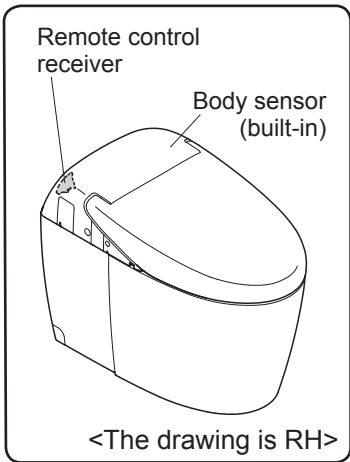
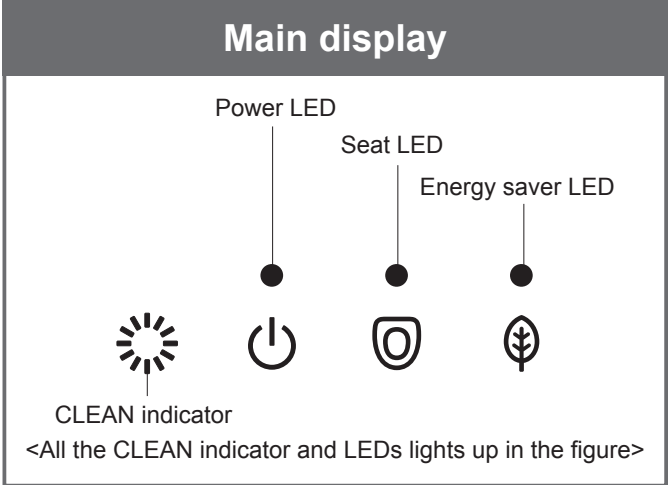

<The drawing is AH>

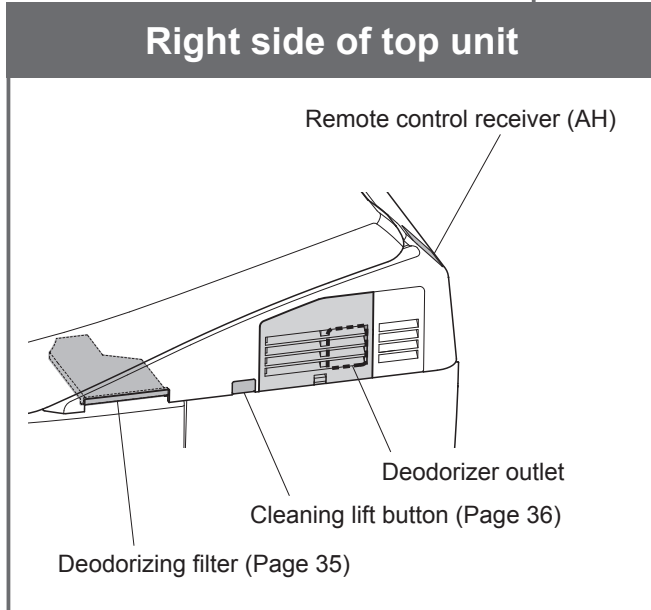
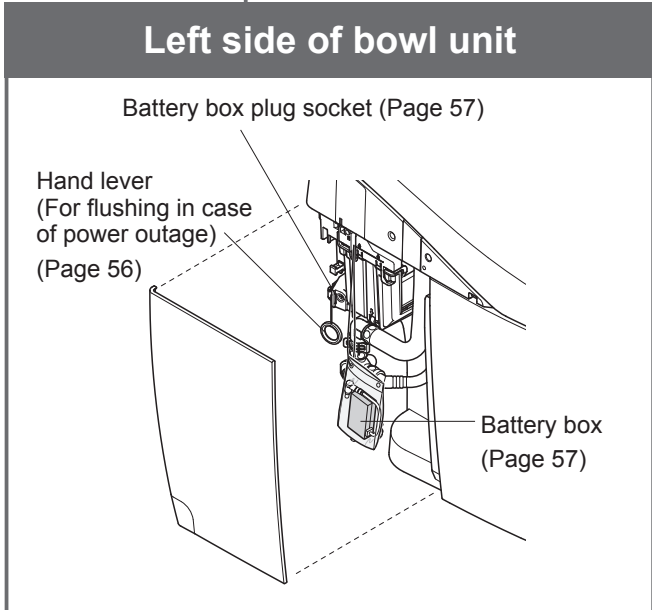
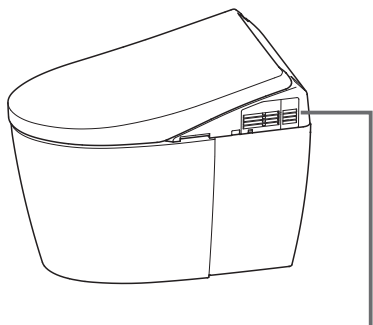
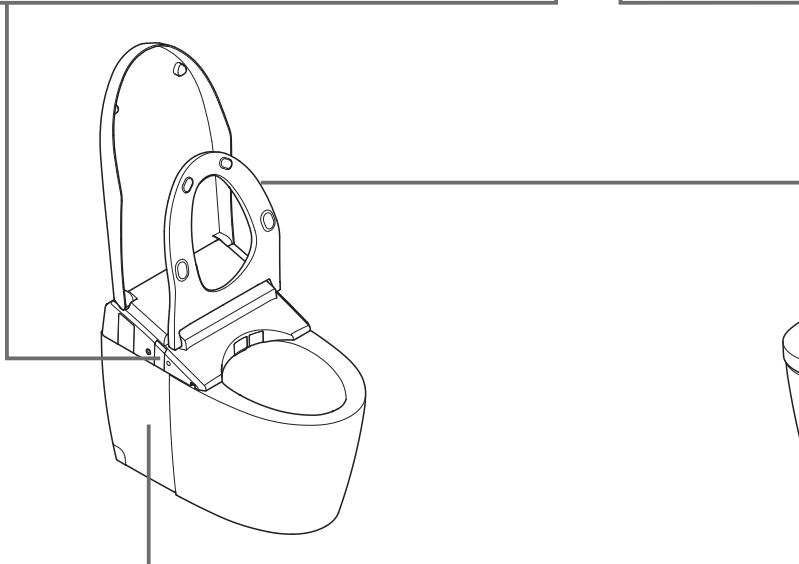
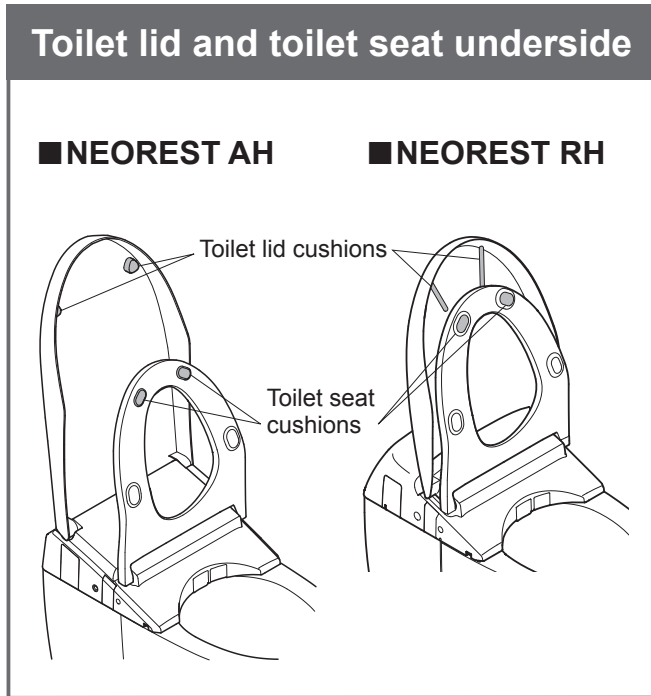
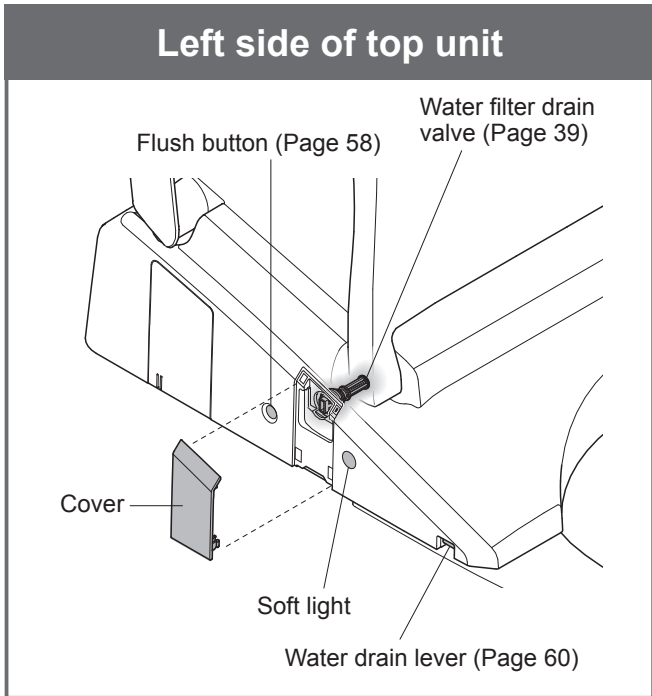



# Preparation

## Using the Product for the First Time

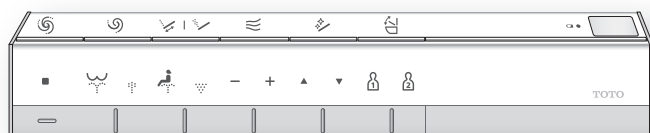

### 1. Insert the battery

**1** Remove the remote control from the hanger.

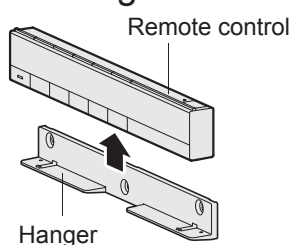

**2** Open the battery cover and insert two AA batteries.

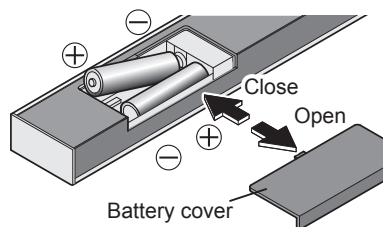

- When batteries are properly inserted, temperature levels appear on the display of the remote control (back side).  
→ When the temperature levels are not displayed, perform step 3 of "Language Selection" in page 52.
- The display goes out when no button on the remote control is pressed for about 60 seconds or more.

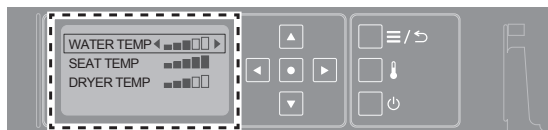

**3** Mount the remote control in the hanger.

#### ■ About the batteries

- Use dry cell, alkaline batteries.
- Be sure to follow "Safety Precautions" to prevent the batteries from rupturing or leaking fluid, etc. (Pages 6, 8)

### If the remote control is secured (for anti theft)

**1** Remove the screws (2, left and right) from the remote control fixture.

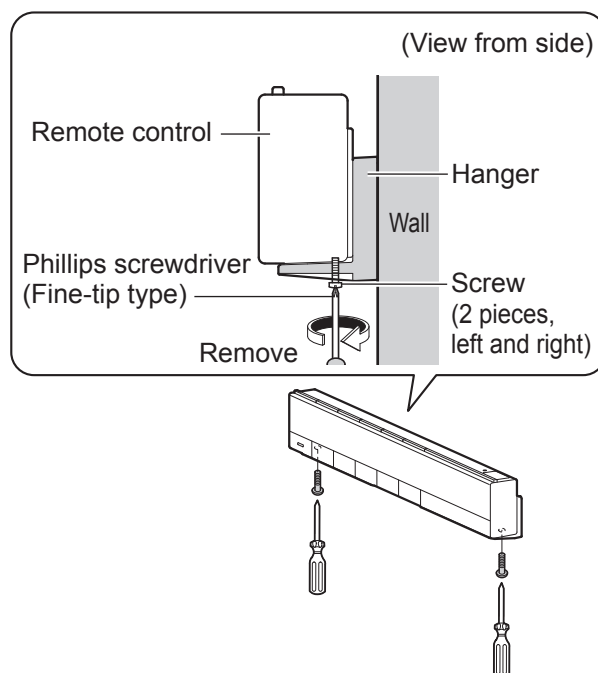

**2** Remove the remote control from the hanger.

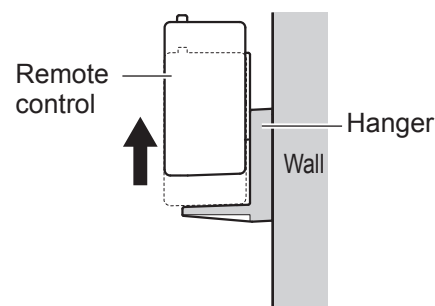

- To secure the remote control again  
Tighten and fix the screws (2, left and right).  
(Overtightening may cause damage to parts such as the hanger.)

## 2. Turn on the power

**1** Insert the power plug.  
• The wand extends and then retracts.

**2** Check that the "Power" LED lights up.

• When it is off, switch the "Power" to "ON".

**To operate from the back of remote control**

 Press "Power ON/OFF" button for about 3 seconds or longer.

**To operate from the front of remote control**

• Recommended if the remote control is secured to prevent theft.

 Press "Oscillating cleansing/ Pulsating cleansing" button about 10 seconds or longer.

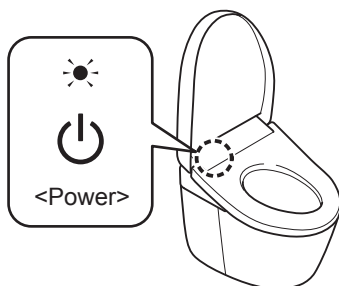

### To turn the power "OFF"

Perform the same operation as step 2 above.

• The "Power" LED goes off.

## 3. Open the shutoff valve

**1** Remove the side panel (left).

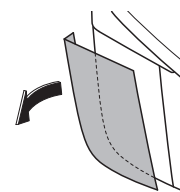

**2** Fully open the shutoff valve.

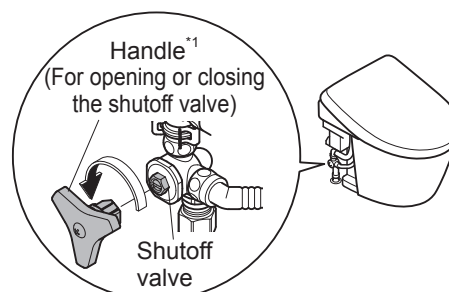

\*1 Installed on the back of the side panel (on the left).

**3** Reinstall the side panel.

• Fit the side panel to the top and side of the bowl unit without a gap.

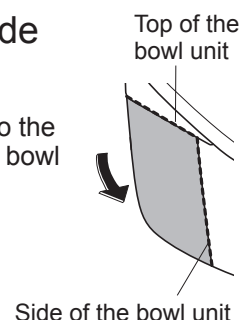

# Basic Operations

Press a button on the remote control; a beep sounds when the top unit receives the signal.

## Cleansing

## Drying

## Stopping

**"Rear cleansing"**  
Cleanses your rear.

**"Rear soft cleansing"**  
Cleanses your rear with soft embracing water flow.

**"Front cleansing"**  
Serves as a bidet for ladies.

**"Wide front cleansing"**  
Gently cleanses a wide area.

**"Warm air drying"**  
Dries your rear.

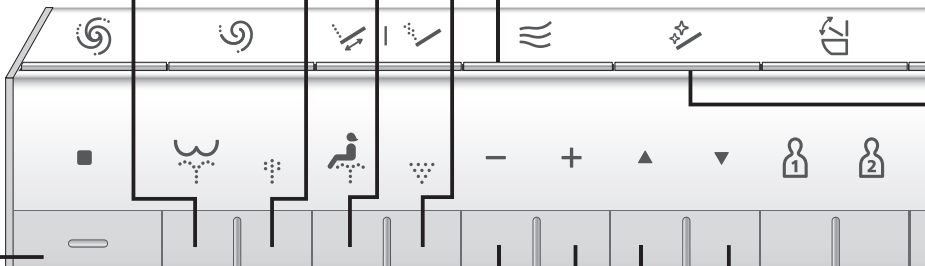

● Functions that operate when a button is pressed during "Rear cleansing", "Rear soft cleansing", "Front cleansing" or "Wide front cleansing".

**Note**

- Sitting back on the toilet seat makes it easier to adjust the wand position and to reduce splashing.

■ **Water pressure adjustment**

You can select from 5 levels of water pressure. ([-] Softer, [+] Stronger)

- When you press the cleansing buttons (Rear, Rear soft, Front, Wide front), the position returns to the standard position (3rd position).

If you do not want to return the wand to the standard position. (Page 54)

■ **Wand position adjustment**

You can select from 5 levels of wand position between the front and the rear, using the [▲] and [▼] buttons.

- When you press the cleansing buttons (Rear, Rear soft, Front, Wide front), the position returns to the standard position (3rd position).

If you do not want to return the wand to the standard position. (Page 54)

✓ **"Oscillating cleansing"**

The wand moves back and forth to cleanse your rear thoroughly.

✓ **"Pulsating cleansing"**

Cleanses with the water pressure pulsating between soft and strong.

The cleansing setting changes each time the button is pressed

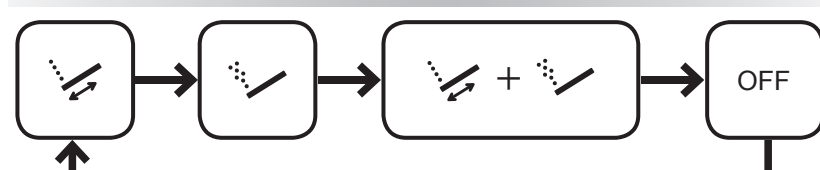

Low battery warning LED (Page 58)



■ **Wand CLEAN**

Cleans the wand with ewater+

- The wand can be automatically cleaned when you use the cleansing functions (Rear cleansing, Front cleansing, etc.). (Page 22)

## When flushing and opening/closing the toilet seat with the remote control

### Flushing

**"Full flush"** Performs a full flush.

- Up to 33 ft (10 m) of toilet paper (single)

**"Light flush"** Performs a light flush.

- Up to 10 ft (3 m) of toilet paper (single)

### Opening and closing

**"Opening and closing the toilet seat"**

Opens and closes the toilet seat.



Operation

#### Personal setting lock

You can store your preferred "Water pressure", "Wand position" and "Warm water temperature" settings.

- To store a settings  
While cleansing is in progress, set your preferred "Water pressure", "Wand position" and "Warm water temperature" and then press and hold or for 2 seconds or longer.
- To use  
Press or , and then press the button for the cleansing you want to use.

Remote control back side



#### Display screen

- The display goes out when no buttons on the remote control is pressed for about 60 seconds or more.

#### "Menu, Return" button (Page 20)

- Adjust settings
- Return to previous menu

#### "Temperature adjustment" button (Page 26)

- Adjust temperatures

#### "Power ON/OFF" button

- Pressing it about 3 seconds or longer turns the power on/off.
- If the remote control is secured to prevent theft (Page 17 Step 2-2)

\*1 Remote control transmitter

# Basic Operations

## About the Menu Screen

This section is an overview of the settings that can be configured with the remote control.

● See the corresponding pages for the detailed descriptions.



Remote control back side

**1** Press

- The display screen changes.

**2** Set the item from the display screen.

When you move the buttons (Up/Down), the frame of the item moves.

When you move the buttons (Right/Left), you can select the setting.

When you press the button, the item is entered.

Number of items on display

\*1

**◆ SELECT ⇒ [●ENTER] PUSH**

The next step is shown at the bottom of the display screen.

\*1 [AIR DEODORIZER] appears but this feature is not available on this product.

You can set as desired

If you want to return to the previous item, press the  button.

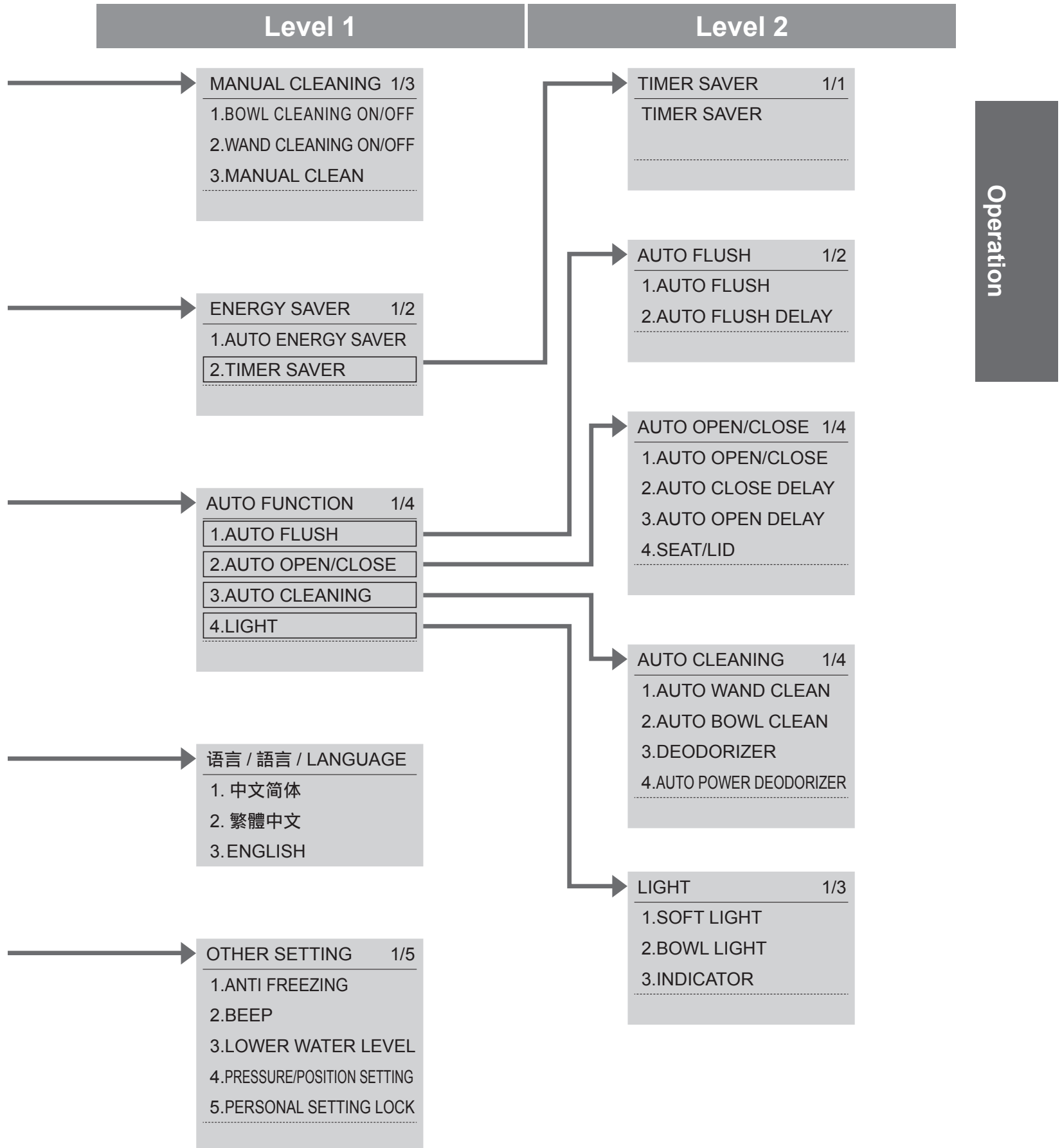

# Automatic Functions

## Cleaning Features

"ewater+"<sup>\*1</sup> is used automatically to clean the wand and bowl unit.

- Operation under the initial settings is described below.

As you approach



As you sit<sup>\*2</sup>



As you stand up



Removing odors inside the bowl unit

**Deodorizer**



Starts the deodorizer



**Starts the auto power deodorizer**

(After about 10 seconds)  
→It stops after about 60 seconds.

Sanitize the wand with "ewater+"<sup>\*1</sup>

**Auto wand CLEAN**

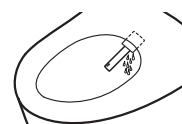

**Cleans the wand automatically**

(After about 25 seconds)  
• Only when the cleansing functions are used.  
→The wand extends and "ewater+"<sup>\*1</sup> comes out from the base of the wand.

Sanitize the bowl unit with "ewater+"<sup>\*1</sup>

**Auto bowl CLEAN**

**Pre-mist**

→A mist is sprayed inside the bowl unit to make it more difficult for dirt to adhere.

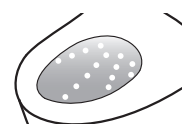

**After-mist**

(After auto wand CLEAN)

• If the cleansing functions are not used, after-mist starts after about 25 seconds.  
→"ewater+"<sup>\*1</sup> mist is sprayed on the bowl unit.

**Bowl light**

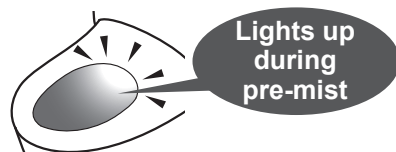

Lights up during pre-mist

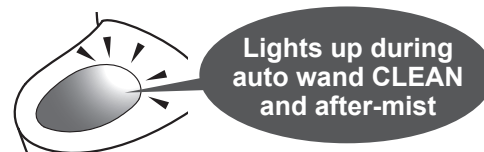

Lights up during auto wand CLEAN and after-mist

**CLEAN indicator**



(Lights up)



(Lights up in a cycle)

Lights to show that the "CLEAN" functions are operating.

**■Bowl light**

Lights to show that auto bowl CLEAN and auto wand CLEAN are operating.

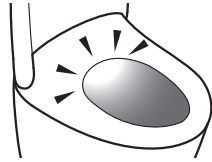

**■CLEAN indicator**

Lights to show that the "clean" functions are operating.

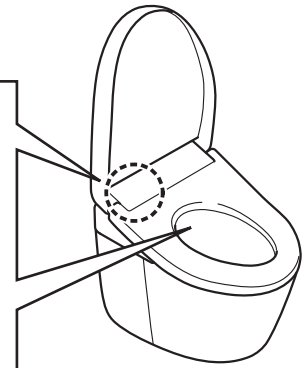

**■Note**

**■Changing settings**

"ewater+" can also be used by pressing the remote control button

Operation

• **Deodorizing filter needs regular maintenance.** (Page 35)

• "Deodorizer" ON/OFF  
• "Auto power deodorizer" ON/OFF  
(Page 48 for all)

For wand

Press "Wand CLEAN" button.

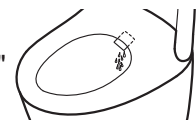

(After wand cleaning, water comes out from around the wand.)

● To clean the wand with it extended.  
→ "Wand cleaning" (Page 38)

• When the cleansing functions (Rear cleansing and Front cleansing etc.) have not been used in 8 hours, the wand is cleaned automatically.  
(Water comes out from around the wand.)

• "Auto wand CLEAN" ON/OFF  
(Page 48)

For bowl unit ("Manual CLEAN")

- 1  ≡ / > Press
- 2  Select [MANUAL CLEANING] →  Press
- 3  Select [MANUAL CLEAN] →  Press

("ewater+" mist is sprayed on the bowl unit)

**Note**

• It cannot be used when the wand is out or when you are sitting on the toilet seat.

• The pre-mist and after-mist are not sprayed if the toilet seat is open.  
• The pre-mist does not work for about 90 seconds after the after-mist has finished.  
• When the cleansing feature (Rear cleansing and Front cleansing etc.) is not used for about 8 hours, mist is sprayed on the bowl unit automatically.

• "Auto bowl CLEAN" ON/OFF  
(Page 48)

● To clean the toilet bowl with a toilet brush or a similar tool (Page 34)

**\*1 What is meant by "ewater+" ?**

This water containing hypochlorous acid generated from chloride ions in tap water, is widely used for cleaning and disinfecting items such as food, utensils and baby bottles.

- Well water may not deliver the required effect. (Because the level of chloride ions is low.)
- "ewater+" helps to minimize dirty surfaces, but does not make cleaning unnecessary.
- The effect and duration vary depending on the usage environment and conditions.

\*2 Water comes out from the area around the wand for several seconds while water is warmed up.

• Lights up continuously or in a cycle when "Auto wand CLEAN", "Auto bowl CLEAN" or "Auto power deodorizer" is operating.  
(Lights only when the toilet seat is not in-use)

• "CLEAN indicator" ON/OFF  
(Page 50)

• "Bowl light" ON/OFF  
(Page 50)



# Automatic Functions

## Convenience Features

Various automatic functions are available.

- Operation under the initial settings is described below.

**As you approach** \*1



**As you sit**



**As you stand up**



Flush automatically  
**Auto flushing**

When using the toilet seat

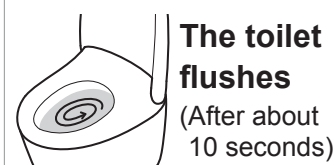

**The toilet flushes**  
(After about 10 seconds)

When standing and using

Opening the toilet lid automatically  
**Auto open/close**

When using the toilet seat

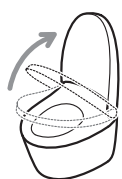

**The toilet lid opens**

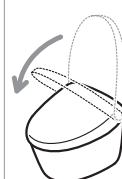

**The toilet lid closes**  
(After about 90 seconds)

When standing and using

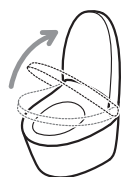

**The toilet lid opens**



Open the toilet seat with the remote control.

Lighting up the inside of the bathroom with a soft light  
**Soft light**

**Lights up in middle mode**

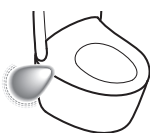

**Lights up in high mode**

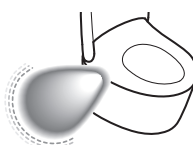

**Lights up in middle mode**  
(About 90 seconds)

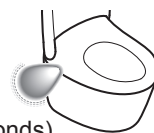

\*1 Detection by the body sensor may be difficult when the toilet is used by someone small, such as a child.

## As you move away

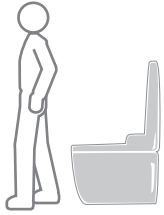

### Note

### Changing settings

- Auto flush is not available in the following cases.
  - · About 60 seconds after the toilet is flushed. (After 60 seconds have passed, flush using the remote control.)
  - When the time spent sitting on the toilet seat or standing in front of the bowl unit is less than about 6 seconds. (Flush with the remote control.)
- The flushing varies depending on how long you sit on the toilet seat.
  - Around 6 to 30 seconds: "Light flush"
  - Around 30 seconds or more: "Full flush"
- When the tank is filling and an LED will flash on the main display, you cannot flush the toilet.
- Depending on factors such as the location of the toilet, it may take up to about 20 seconds for light flush to start when using standing up.

- "Auto flushing" ON/OFF
- "Auto flush delay" (5 seconds, 10 seconds or 15 seconds) (Page 44 for all)



**The toilet flushes**  
(Performs a "Light flush" about 3 seconds after the user has moved about 1.3 ft (about 40 cm) away from the bowl unit.)

- When the toilet lid is closed by hand, it cannot open automatically for about 15 seconds. (Open and close by hand.)
- When you do not sit on the toilet seat, or when you sit on it or stand in front of the bowl unit briefly, it takes about 5 minutes before the lid closes automatically.

- "Auto open/close" ON/OFF
- "Auto open delay" (15 seconds, 30 seconds or 90 seconds)
- "Auto close delay" (25 seconds or 90 seconds)
- "Seat/lid" (Lid/Seat · Lid) (Page 46 for all)



**The toilet lid and toilet seat close**  
(About 90 seconds after moving away from the bowl unit by about 1.3 ft (about 40 cm) or more.)

**Lights up in low mode**

(Goes out after about 5 seconds)



- "Soft light" ON/OFF (Page 50)

# Temperature Adjustment

## Warm Water, Toilet Seat, Drying



Five different temperature levels from high to low and "OFF" can be set.

**1** Remove the remote control from the hanger.

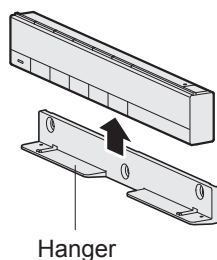
- If the remote control is secured to prevent theft (Page 16)



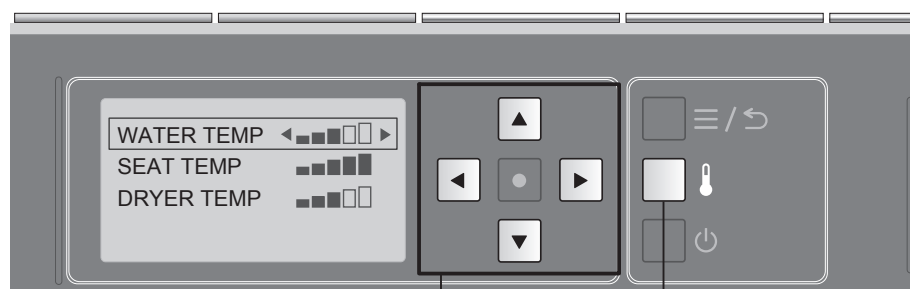
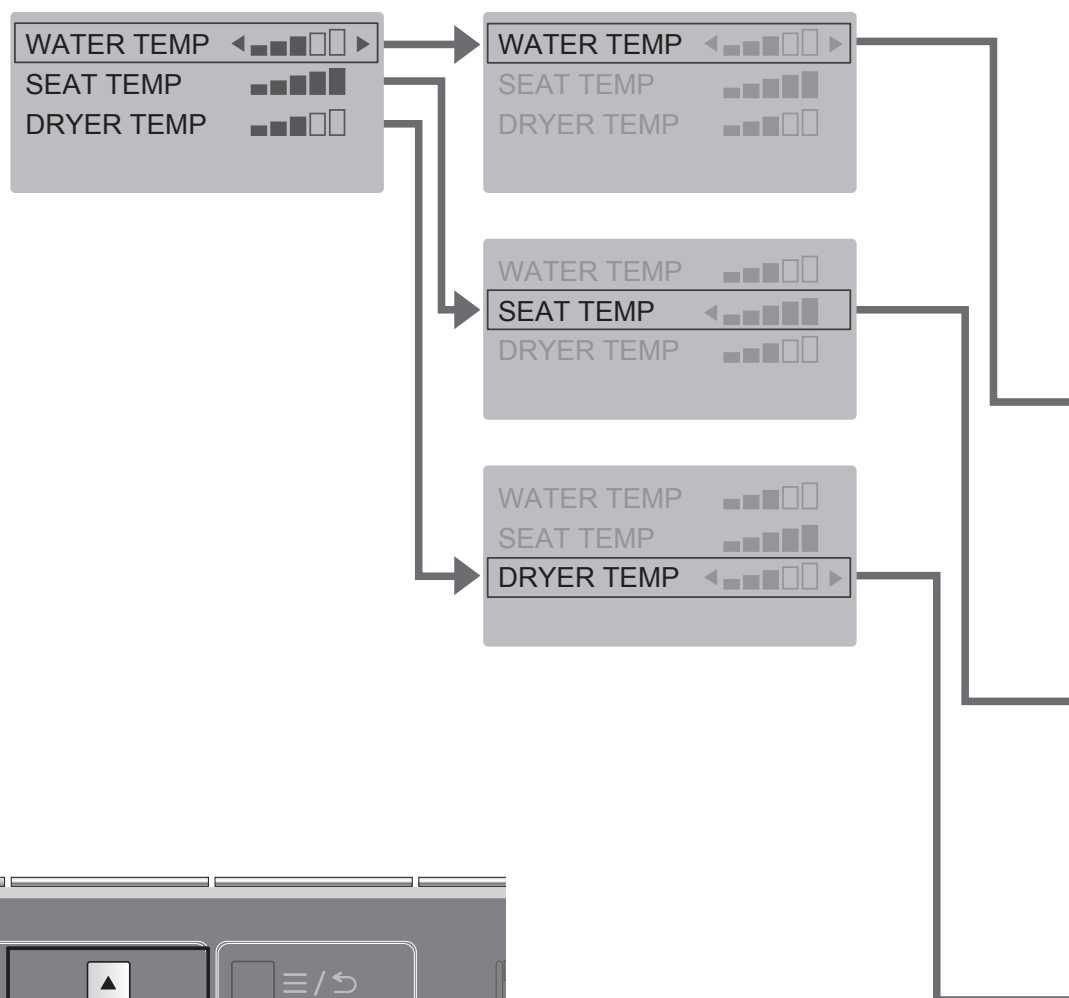

**2**  Press

**3**   Select the item you want to set.



Remote control back side

Temperature adjustment button

  Move the frame.

  Select the setting.

### CAUTION

- During setting, the display goes out when no button is pressed within about 60 seconds.  
If you fail to complete the setting, redo from the step 2.

**4** ◀ ▶ Select the temperature level.

<Settings complete>

**5** Mount the remote control in the hanger.

- If the remote control is secured to prevent theft (Page 16)

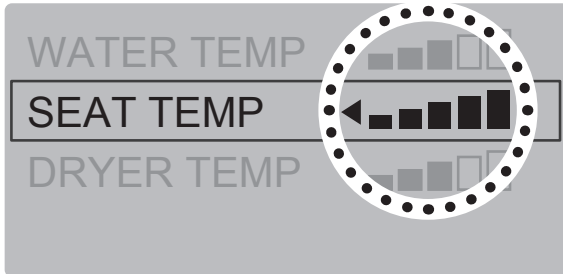

**Warm water temperature**

Press ◀ until [OFF] appears.

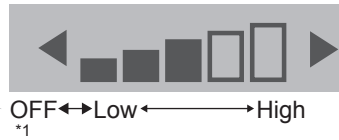

**Toilet seat temperature**

Press ◀ until [OFF] appears.

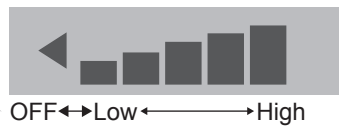

- When "OFF" is set, the "Seat" LED on the main display will go off.

**Drying air temperature**

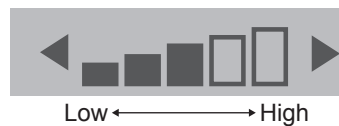

- The "Drying" cannot be turned "OFF".

\*1 To prevent condensation, the water temperature does not drop below 68°F (20°C) even when set to "OFF".

● If adjusting the temperature does not warm up the toilet seat → Is "Energy saver" set to "ON"? (Page 28)

# Energy Saver Features

Type

"Auto energy saver", "Auto energy saver+" or "Timer energy saver" can be selected. To save energy, the temperature of the toilet seat becomes low (or "OFF").

● "Auto energy saver" takes about 10 days to detect time periods in which the toilet seat is never or infrequently used.

Type	Situation	Energy saver is on	
		Main display	
<b>Auto energy saver</b>	<p><b>You want the product to save energy automatically.</b></p> <p>The product detects time periods with infrequent use and lowers the toilet seat temperature automatically.</p>		→
<b>Auto energy saver+</b>	<p><b>You want to save more energy.</b></p> <p>In addition to the "Auto energy saver" feature, it automatically turns off the toilet seat heater during time periods when the toilet is never used.</p>		→
<b>Timer energy saver</b>	<p><b>You want to save energy only for the preset duration of time. (6 hours, 9 hours)</b></p> <p>Once the time is set, the toilet seat heater turn off automatically during the set time period every day.</p>		→
<b>Timer energy saver + Auto energy saver / Auto energy saver+</b>	<p><b>You want to save a lot of energy with auto energy saver and timer energy saver.</b></p> <p>When <b>both</b> "Timer energy saver" and "Auto energy saver / Auto energy saver+" are <b>set</b>, "Auto energy saver / Auto energy saver+" operates when "Timer energy saver" is not operating.</p>		<p>Energy saver is off</p>

● Even if the energy saver feature is on (i.e., the toilet seat heater is set to "Low" or "OFF"), the toilet seat is heated to the set temperature in about 15 minutes.  
 (The LED indication on the main display returns to the state for when the energy saver is on.)

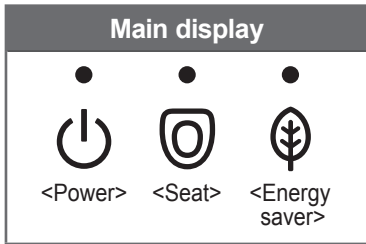

When energy saver is in operation		AM		PM				
Toilet seat heater		0	4	6	8	5	9	0
		Example: Used infrequently from 9 pm to 6 am 						
	 	Example: Not used from 0 am to 4 am 						
		Example: Set from 8 am to 5 pm 						
<ul style="list-style-type: none"> <li>● During "Auto energy saver / Auto energy saver+": Same LED indication as "Auto energy saver / Auto energy saver+" (see above)</li> <li>● During "Timer energy saver": Same LED indication as "Timer energy saver" (see above)</li> </ul>	 	Example: When "Timer energy saver" and "Auto energy saver+" are used together 						

Operation

\*1 The toilet seat temperature set on page 26.  
 \*2 The time period when the toilet seat heater is set to a "Low".  
 \*3 The time period when the toilet seat heater is set to a "OFF"



# Energy Saver Features

## How to Set

Set the "Timer energy saver" at the time you want to start it.

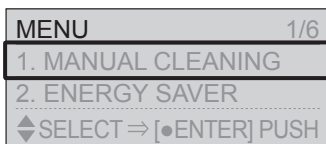
**1**  Press



**2**   Select [ENERGY SAVER]

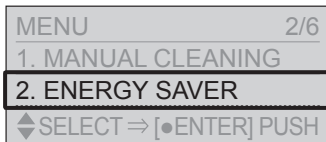



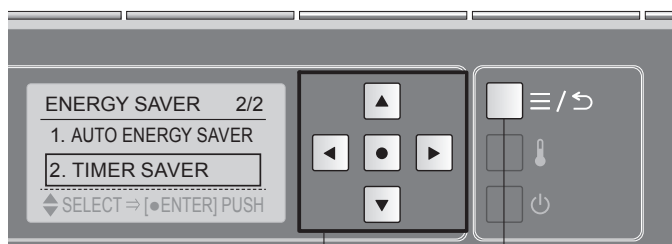

 Press



Remote control back side

Menu, Return button

-  : Move the frame.
-  : Move the frame.
-   : Select the setting.
-  : Confirm the setting.

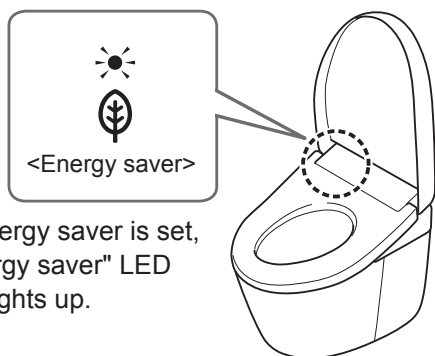

When energy saver is set, the "Energy saver" LED (green) lights up.

### CAUTION



- During setting, the display goes out when no button is pressed within about 60 seconds. If you fail to complete the setting, redo from the step 1.

Auto energy saver



Auto energy saver+

Timer energy saver

Turning off energy saver

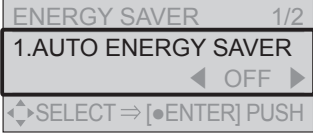

**3**   Select [AUTO ENERGY SAVER]



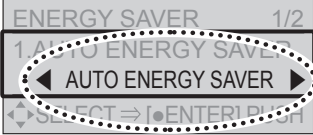

**4**   Select [AUTO ENERGY SAVER]





Press  AUTO ENERGY SAVER ON

(To return →  / )

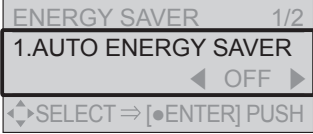

**3**   Select [AUTO ENERGY SAVER]



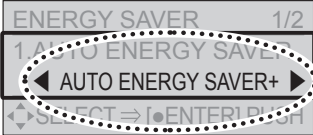

**4**   Select [AUTO ENERGY SAVER+]





Press  AUTO ENERGY SAVER+ ON

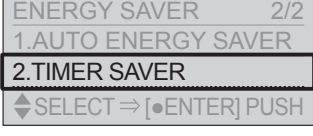

(To return →  / )



**3**   Select [TIMER SAVER]



**4**   Select [6H], [9H] or [OFF]





Press  Press  TIMER SAVER ON



(To return →  / )

■ To change the timer energy saver time → Set the timer energy saver again at the time you want to start it.

Select [OFF] in step 4 in each procedure above.



Press  TIMER SAVER OFF

(To return →  / )

(Example: "Timer energy saver")



# Maintenance

## Power Plug

### Power Plug (Approximately once a month)

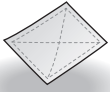

Dry cloth



Wet cloth

- 1 Unplug the power plug and wipe it with a dry cloth.



- 2 Insert the power plug.
  - The "Power" LED lights up.

### WARNING

- Periodically remove dust from the blades and other parts of the power plug.
  - Unplug the power plug and wipe it with a dry cloth.
- Fully insert the power plug.
- When unplug the power plug, hold the main body of the power plug.
  - Pulling the power cord may damage the power plug or power cord.



### WARNING

- Always unplug the power plug from the outlet before maintenance or inspection.
  - (Failure to do so may cause electric shock or malfunction, resulting in a breakdown.)

For safety, unplug the power plug before maintenance. \*1

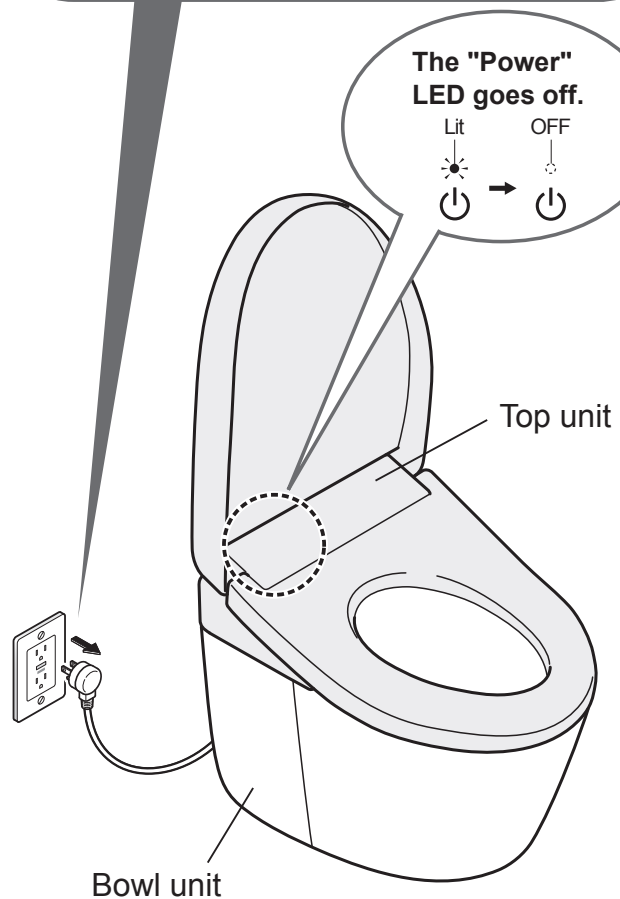

- Do not use a dry cloth or toilet paper on plastic parts.
  - (May cause damage.)

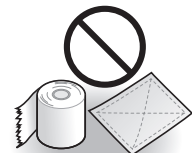

\*1 Except when using "Wand cleaning" or "Bowl unit cleaning".

\*1 After the power plug is inserted, the toilet lid does not open automatically for about 10 seconds. (Because it is preparing for operation.) Open and close by hand.

# Top Unit

## Top Unit (Approximately daily)



Soft cloth soaked  
in water

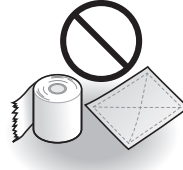

- Toilet paper
- Dry cloth
- Nylon scrubbing brush  
(May cause damage.)

**1** Unplug the power plug.

**2** Wipe with a soft cloth that has been soaked in water and wrung-out thoroughly.

### ■ For heavy dirt

- Wipe with a soft cloth soaked in diluted, neutral kitchen detergent, and then wipe with a soft cloth soaked in water.



- Neutral kitchen detergent



- Paint thinner
- Benzene
- Powdered cleanser

**3** Insert the power plug.

- The "Power" LED lights up.

### Attention!

- This product is an electric appliance. Be careful not to let water seep inside or leave detergent in the gap between the top unit and bowl unit.  
(May damage plastic parts or cause a malfunction.)
- When using a toilet cleaner to clean the toilet, rinse it off within 3 minutes and leave the toilet seat and toilet lid open.
  - Wipe off any cleaner that remains on the bowl unit. (If vapor from a toilet cleaner enters the top unit, it may cause a malfunction.)
- Do not push or pull the covers around the wand with undue force.  
(May cause damage or malfunction.)
- Wipe the back surface of the toilet seat and the toilet seat cushions with a soft cloth tightly wrung out with water. (Otherwise adhesion of dirt may result in discoloration.)

# Maintenance

## Bowl Unit

### Bowl Unit (Approximately daily)



- Toilet brush
- Neutral toilet detergent



- Strongly acidic cleaners or strong alkaline cleaners
- Cleaners containing abrasive compounds
- Fluoride-based detergent (containing hydrogen fluoride or ammonium fluoride)
- Wire brush
- Abrasive nylon scrubbing brush

1

Unplug the power plug.

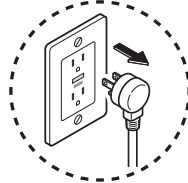

2

Clean with a toilet brush or a similar tool.



■ **The water level in the bowl unit can be lowered to perform maintenance.**

(Insert the power plug.)

<"Bowl unit cleaning"> Operate with the buttons on the back side of the remote control.

(1)  Press

(2)  Select [MANUAL CLEANING] →  Press

(3)  Select [BOWL CLEANING ON/OFF] →  Press

- The water in the bowl unit flows, and then drains. After that, the water level drops for about 50 seconds.

**Clean inside the bowl unit.**

- The water in the bowl unit drains, and then returns to its original level.

● **To stop part way through,**

press  ("Stopping" button) on the front side of the remote control.

■ **If the bowl unit is clogged**

- Using plunger or similar, provide 4 in (10 cm) or more clearance between the top of the bowl unit and the water surface. Use commercially available tools that are made for unclogging the bowl unit. (May cause overflow of dirty water and water damage.)

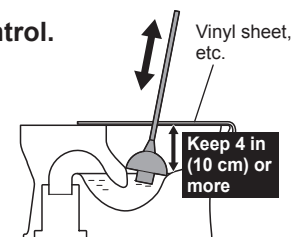

■ **If the floor is dirty**

- Clean it with a well wrung cloth. (Not cleaning the floor may cause stains or corrosion.)
- Sitting is recommended to reduce splashing caused by standing and urinating.

3

Insert the power plug.

- The "Power" LED lights up.

#### Attention!

- Be careful not to expose the top unit or the gap between it and the bowl unit to water. (May cause water overflow into the room.)
- Do not use any water repellent, stain-proofing cleaner or surface coating agent. These products would not damage the porcelain surface, but they may cover the porcelain surface and reduce the effect of the built-in stain prevention technology.

## Deodorizing Filter

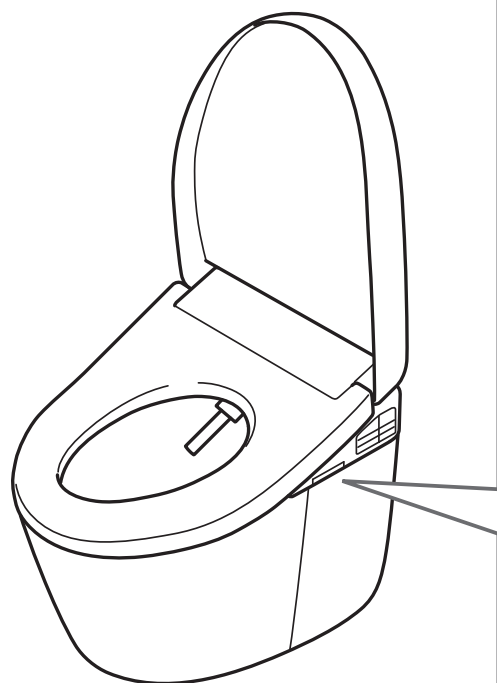

### Deodorizing Filter (Approximately once a month)

- 1** Unplug the power plug.
- 2** Remove the deodorizing filter.
  - Hold the knob and pull outward.
  - Do not pull with undue force.  
(May cause damage or malfunction.)

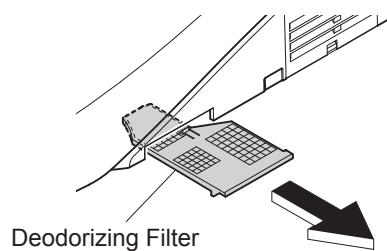

- 3** Clean with a tool such as a toothbrush.
  - When washing with water, dry off all water before mounting.

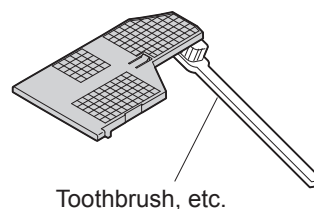

- 4** Mount the deodorizing filter.

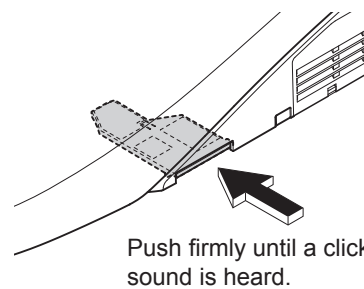

- 5** Insert the power plug.
  - The "Power" LED lights up.

# Maintenance

## Gap between the Top Unit and Bowl Unit

### Gap between the Top Unit and Bowl Unit (Approximately once a month)

You can lift up the top unit with the cleaning lift button and clean the gap between it and the bowl unit.

**1** Unplug the power plug.

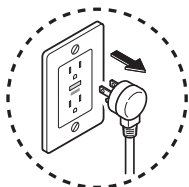

Soft cloth soaked in water

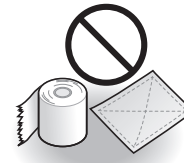

Toilet paper, etc.  
(May cause damage.)

**2** Open the toilet seat and lid.

**3** Press the cleaning lift button.  
• This raises the front side of the top unit.

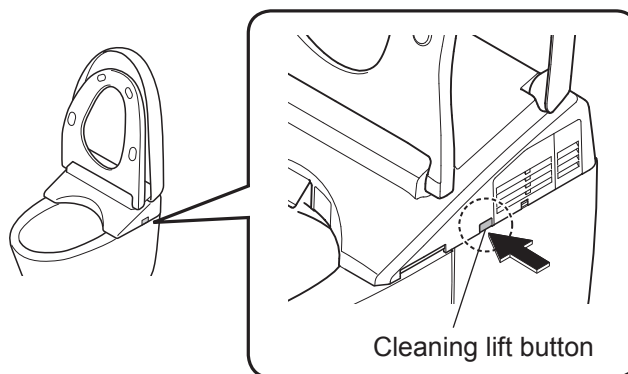

**4** Clean the gap.  
• Wipe with a soft cloth soaked in a diluted, neutral kitchen detergent. Then, wipe it with a soft cloth soaked in water so that no detergent remains.

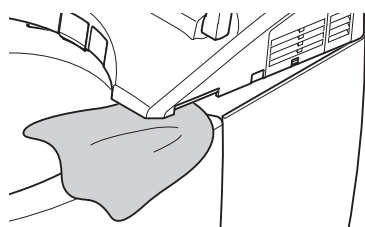

**! CAUTION**

- Do not use the product while the top unit is lifted up by the cleaning lift.
- When lowering the top unit by the cleaning lift, do not insert your fingers into the gap between the top unit and the bowl unit.

**Attention!**

- Do not directly spray cleaner and water.
- Do not force the toilet seat or lid to move while the top unit is raised up.

**5** Close the toilet seat and push it firmly until a click sound is heard.

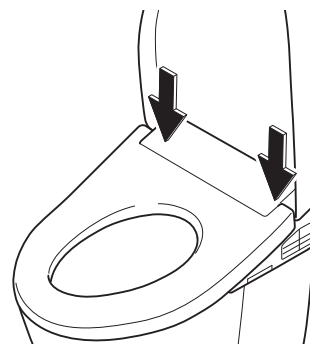

**6** Insert the power plug.  
• The "Power" LED lights up.

# Gap between the Top Unit and the Toilet Lid

## Gap between the Top Unit and the Toilet Lid (Approximately once a month)

The toilet lid can be removed for thorough cleaning.

**1** Unplug the power plug.

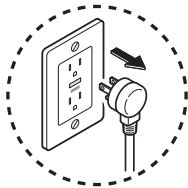

**2** Remove the toilet lid.

**Confirm the model (AH or RH)!**

Slightly tilt the toilet lid to the front.

(A) : <AH> Pull right side outward.  
<RH> Pull left side outward.

(B) : Disconnect the hinge from the tab and pull up.

(C) : Remove the toilet lid.

**3** Wipe with a soft cloth that has been soaked in water and wrung-out thoroughly.

**4** Reinstall the toilet lid.

(D) : <AH> Align the right side pin and hinge parts.  
<RH> Align the left side pin and hinge parts.

Slightly tilt the toilet lid to the front.

(A) : <AH> While pulling left side outward.  
<RH> While pulling right side outward.

(E) : Mount by joining the hinge with the tab.  
• Be careful not to pinch your fingers.

**5** Insert the power plug.

• The "Power" LED lights up.

**6** Open and close the toilet lid to check the reinstallation.



Soft cloth soaked in water

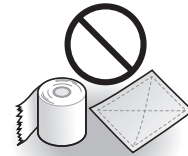

Toilet paper, etc.  
(May cause damage.)

<Removing and Reinstalling>

**For AH**

Hold with both hands

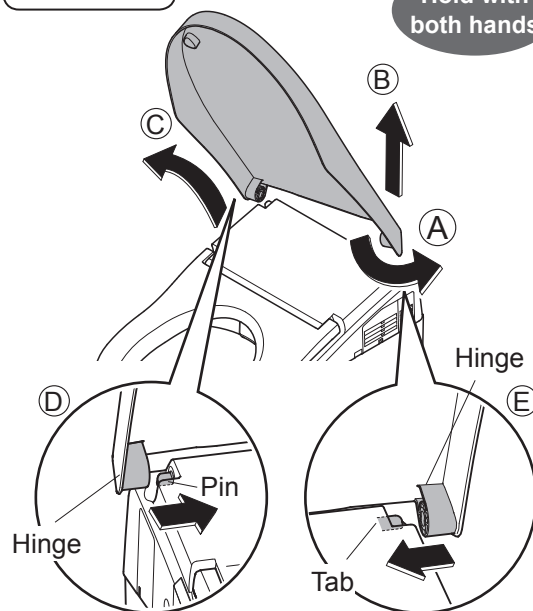

**For RH**

Hold with both hands

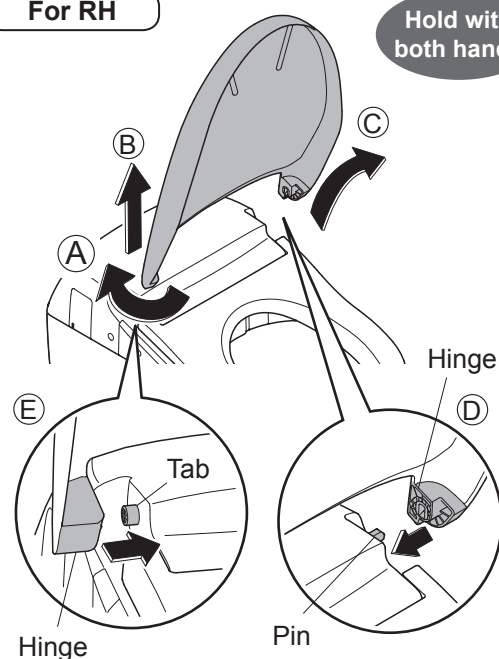

# Maintenance

## Wand

### Wand (Approximately once a month) < If you notice dirt (Wand cleaning)>



Soft cloth

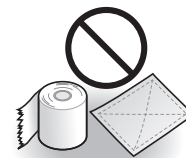

Toilet paper, etc.  
(May cause damage.)

# 1

### Extend the wand.

#### To operate from the back of remote control

- (1) Press
- (2) Select [MANUAL CLEANING] → Press
- (3) Select [WAND CLEANING ON/OFF] → Press

#### To operate from the front of remote control

• Recommended if the remote control is secured to prevent theft.

- (1) Press "Stopping" button about 10 seconds or longer.
- (2) Press "Front cleansing" button about 3 seconds or longer.

- The wand extends and water sprays out for cleaning.
- The wand automatically retracts after about 5 minutes.

# 2

### Wipe with a soft, wet cloth.

- Do not pull, push or press the wand with excessive force.  
(May cause damage or malfunction.)

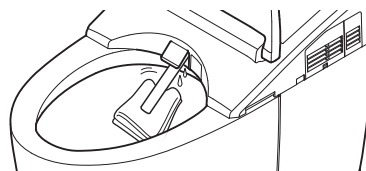

# 3

### Press "Stopping" button on the front side of the remote control.

- The wand retracts.

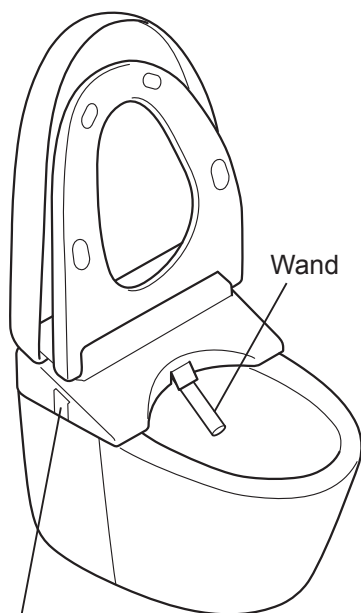
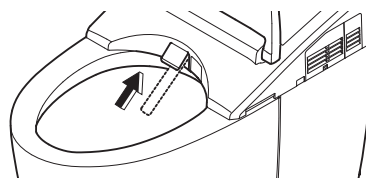

Water filter drain valve

## Water Filter Drain Valve

### Water Filter Drain Valve (Approximately once every 6 months) <If you think the water pressure has weakened>

**1** Close the shutoff valve.  
(Page 63)

- The water supply stops.

**CAUTION**

 Do not remove the water filter drain valve while the shutoff valve is open.  
(Otherwise, water may leak out.)

**2**  Press

"Wand CLEAN" button.

- The wand cover opens.  
(Release the pressure from the water supply pipe.)

**3** Unplug the power plug.

**4** Remove the cover and water filter drain valve.

- Loosen the water filter drain valve with a flat-head screwdriver and then pull it.

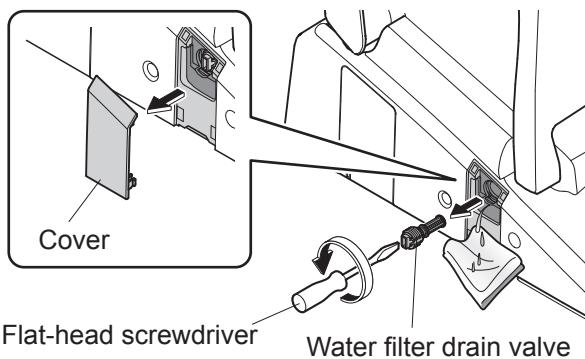

**5** Clean with a tool such as a toothbrush.

- Also, remove any dust from inside the hole of the water filter drain valve.

**6** Reinstall the water filter drain valve and cover.

- Insert the water filter drain valve and use a flat-head screwdriver to tighten it securely.

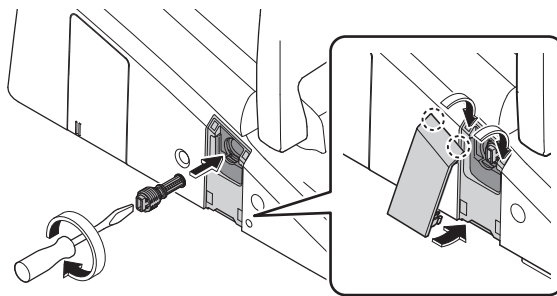

**7** Insert the power plug.

- The "Power" LED lights up.

**8** Open the shutoff valve.  
(Page 17)



# Maintenance

## Water Filter (Bowl Unit)

### Water Filter (Bowl Unit) (Approximately once every 6 months)

**1** Remove the side panel (left).

There is an opening/closing tool (accessory) on the rear surface.

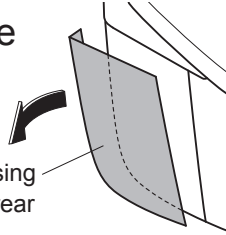

**2** Close the shutoff valve.  
(Page 63)

• The water supply stops.

#### **CAUTION**



**Do not remove the water filter while the shutoff valve is open.**

(Otherwise, water may leak out.)

**3**  Press

"Wand CLEAN" button.

• The wand cover opens.  
(Release the pressure from the water supply pipe.)

**4** Unplug the power plug.

**5** Loosen the cap of the water filter to remove the water filter.

• Use the opening/closing tool (accessory).

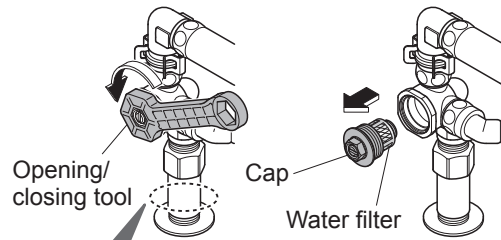

Hold the pipe with hands while loosening the cap.

**6** Remove the water filter from the cap and clean it with a toothbrush or similar instrument.

• Do not use detergent.  
• Do not apply excessive force to the water filter. (May cause deformation)

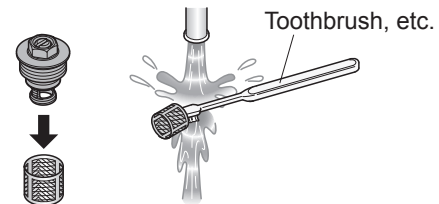

**7** Install the water filter to the cap, then tighten the cap with the opening/closing tool.

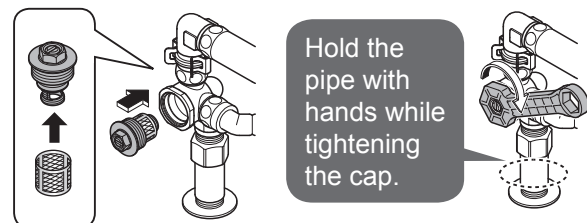

8

Open the shutoff valve.  
(Page 17)

- Check that there are no leaks in the shutoff valve or plumbing connections.

9

Mount the opening/closing tool to its original position and reinstall the side panel.

- Fit the side panel to the top and side of the bowl unit without a gap.

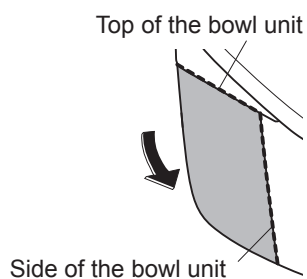

10

Insert the power plug.

- The "Power" LED lights up.

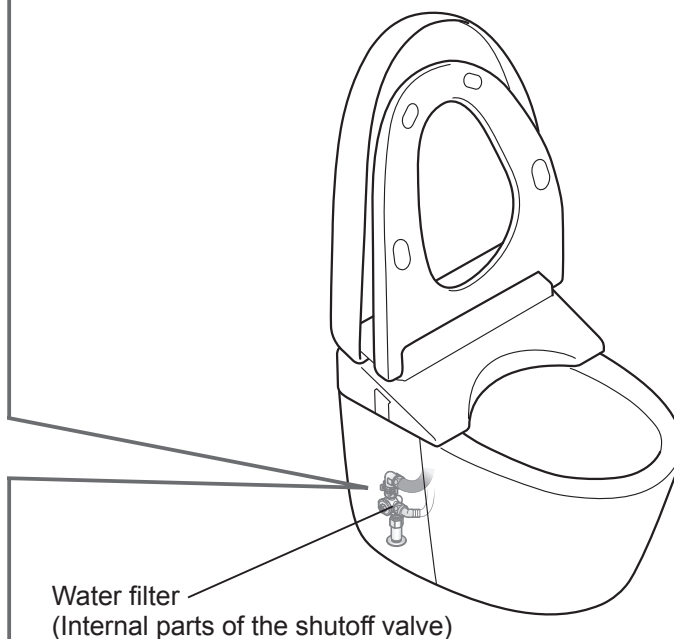

# Changing Settings

## Setting List

Setting Types		
Auto functions	Auto flushing	Auto flushing
		Auto flush delay
	Auto open/close	Auto open/close
		Auto close delay
		Auto open delay
		Seat/lid
	Auto cleaning	Auto wand CLEAN
		Auto bowl CLEAN
		Deodorizer
		Auto power deodorizer
	Light	Soft light
		Bowl light
		CLEAN indicator
Language settings		
Other settings	Anti freezing	
	Beep sound	
	Lower water level	
	Pressure/position setting	
	Personal setting lock	

### CAUTION

- During setting, the display goes out when no button is pressed within about 60 seconds. If you fail to complete the setting, redo from the step 1.

		Available Settings •Bold: "Initial settings"	Setting Ref. Page
	• Set whether or not to <b>clean the bowl unit automatically</b>	<b>ON/OFF</b>	Page 44
	• Change <b>the amount of time before the toilet flushes automatically</b>	5seconds/ <b>10seconds</b> / 15seconds	
	• Set whether or not to <b>open and close the toilet lid automatically</b>	<b>ON/OFF</b>	Page 46
	• Change <b>the amount of time before the lid/seat closes automatically</b>	25seconds/ <b>90seconds</b>	
	• Change <b>the amount of time after which the lid/seat opens automatically upon closing it with hands</b>	<b>15seconds</b> / 30seconds/ 90seconds	
	• Automatically open and close the <b>toilet lid only</b> / Automatically open and close the <b>toilet seat and toilet lid</b>	<b>LID/Seat</b> · Lid	
	• Set whether or not to <b>clean the wand automatically</b>	<b>ON/OFF</b>	Page 48
	• Set whether or not to <b>spray mist in the bowl unit automatically</b>	<b>ON/OFF</b>	
	• Set whether or not to <b>deodorize automatically after sitting on the toilet seat</b>	<b>ON/OFF</b>	
	• Set whether or not to <b>power deodorize automatically after standing up</b>	<b>ON/OFF</b>	
	• Set whether or not to <b>use the soft light</b>	<b>ON/OFF</b>	Page 50
	• Set whether or not to <b>use the light inside the bowl unit</b>	<b>ON/OFF</b>	
	• Set whether or not to <b>light up the CLEAN indicator</b>	<b>ON/OFF</b>	
	• <b>Select the language</b> displayed on the back of remote control	Simplified chinese/ Traditional chinese/ English	Page 52
	• Set whether or not to <b>run the water for the bowl unit and top unit automatically at a fixed interval in order to prevent freezing</b> (dynamic mode→Page 59)	<b>ON/OFF</b>	Page 54
	• Set whether or not to <b>make a beep sound</b>	<b>ON/OFF</b>	
	• Lower the bowl unit water level	-	
	• Set whether or not to <b>keep your favorite pressure and position settings</b>	<b>ON/OFF</b>	
	• Set whether or not to <b>use the personal setting lock</b>	<b>ON/OFF</b>	

# Changing Settings

## Auto flushing

**1** Press

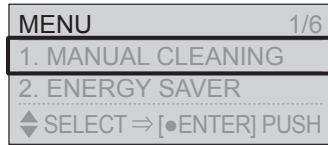

**2** Select [AUTO FUNCTION]

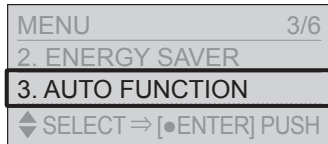

Press

**3** Select [AUTO FLUSH]

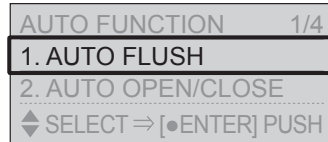

Press

Set whether or not to clean the bowl unit automatically

### Auto flushing

Change the amount of time before the toilet flushes automatically

### Auto flush delay<sup>\*1</sup>

Remote control back side



Items set on this display

- 1. AUTO FLUSH  
"Auto flushing"
- 2. AUTO FLUSH DELAY  
"Auto flush delay"

Menu, Return button

- Move the frame.
- Move the frame.
- Select the setting.
- Confirm the setting.

4   Select [AUTO FLUSH]

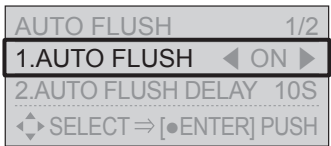

5   Select [ON] or [OFF]

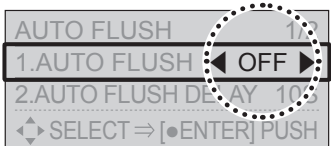

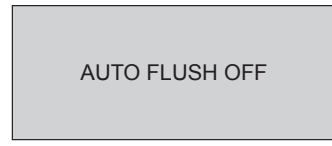

 Press

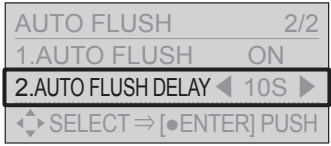

(To return →  ≡ / ↵)

4   Select [AUTO FLUSH DELAY]



5   Select [5S], [10S] or [15S]

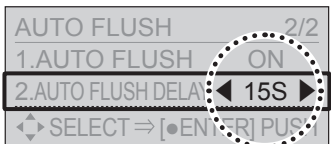

 Press



(To return →  ≡ / ↵)

\*1 This operation is not available when the "Auto flushing" is "OFF".

# Changing Settings

## Auto open/close

**1** Press

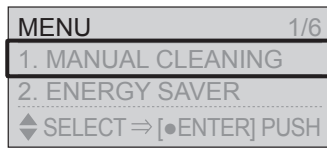

**2** Select [AUTO FUNCTION]

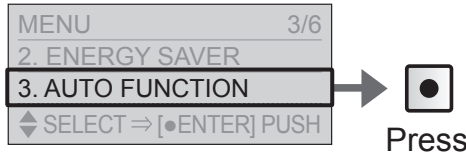

**3** Select [AUTO OPEN/CLOSE]

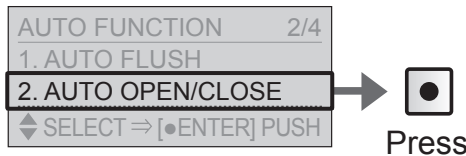

Set whether or not to open and close the toilet lid automatically

**Auto open/close**

Change the amount of time before the lid/seat closes automatically

**Auto close delay<sup>\*1</sup>**

Change the time period till automatic opening (after closing by hand.)

**Auto open delay<sup>\*1</sup>**

Automatically open and close the toilet lid only/  
Automatically open and close the toilet seat and toilet lid

**Seat/lid<sup>\*1</sup>**

Remote control back side



**Items set on this display**

- 1. AUTO OPEN/CLOSE  
"Auto open/close"
- 2. AUTO CLOSE DELAY  
"Auto close delay"
- 3. AUTO OPEN DELAY  
"Auto open delay"
- 4. SEAT/LID  
"Seat/lid"

- Move the frame.
  - Select the setting.
  - Confirm the setting.
- Menu, Return button

4   Select  
[AUTO OPEN/  
CLOSE]

AUTO OPEN/CLOSE 1/4  
1.AUTO OPEN/CLOSE ◀ ON ▶  
2.AUTO CLOSE DELAY 90S  
◀ SELECT ⇒ [●ENTER] PUSH

5   Select  
[ON] or [OFF]

AUTO OPEN/CLOSE 1/4  
1.AUTO OPEN/CLOSE ◀ OFF ▶  
2.AUTO CLOSE DELAY 90S  
◀ SELECT ⇒ [●ENTER] PUSH

 Press

AUTO OPEN/CLOSE OFF

(To return →  ≡ / ↵)

4   Select  
[AUTO CLOSE  
DELAY]

AUTO OPEN/CLOSE 2/4  
1.AUTO OPEN/CLOSE ON  
2.AUTO CLOSE DELAY ◀ 90S ▶  
◀ SELECT ⇒ [●ENTER] PUSH

5   Select  
[25S] or [90S]<sup>2</sup>

AUTO OPEN/CLOSE 2/4  
1.AUTO OPEN/CLOSE ON  
2.AUTO CLOSE DELAY ◀ 25S ▶  
◀ SELECT ⇒ [●ENTER] PUSH

 Press

AUTO CLOSE DELAY 25S

(To return →  ≡ / ↵)

4   Select  
[AUTO OPEN  
DELAY]

AUTO OPEN/CLOSE 3/4  
2.AUTO CLOSE DELAY 90S  
3.AUTO OPEN DELAY ◀ 15S ▶  
◀ SELECT ⇒ [●ENTER] PUSH

5   Select  
[15S], [30S] or  
[90S]

AUTO OPEN/CLOSE 3/4  
2.AUTO CLOSE DELAY 90S  
3.AUTO OPEN DELAY ◀ 30S ▶  
◀ SELECT ⇒ [●ENTER] PUSH

 Press

AUTO OPEN DELAY 30S

(To return →  ≡ / ↵)

4   Select  
[SEAT/LID]

AUTO OPEN/CLOSE 4/4  
3.AUTO OPEN DELAY 15S  
4.SEAT/LID ◀ LID ▶  
◀ SELECT ⇒ [●ENTER] PUSH

5   Select  
[LID] or  
[SEAT·LID]<sup>3</sup>

AUTO OPEN/CLOSE 4/4  
3.AUTO OPEN DELAY 15S  
4.SEAT/LID ◀ SEAT·LID ▶  
◀ SELECT ⇒ [●ENTER] PUSH

 Press

AUTO OPEN/CLOSE  
SEAT·LID

(To return →  ≡ / ↵)

\*1 This operation is not available when the "Auto open/close" is "OFF".

\*2 When set to "25 seconds", the lid/seat does not open automatically for about 15 seconds after closing automatically.

\*3 When the "Seat/lid" are set to open automatically, pre-mist is not sprayed.



# Changing Settings

## Auto cleaning

**1** Press

**2** Select [AUTO FUNCTION] Press

**3** Select [AUTO CLEANING] Press

MENU 1/6

1. MANUAL CLEANING

2. ENERGY SAVER

◆ SELECT ⇒ [●ENTER] PUSH

---

MENU 3/6

2. ENERGY SAVER

3. AUTO FUNCTION

◆ SELECT ⇒ [●ENTER] PUSH

---

AUTO FUNCTION 3/4

2. AUTO OPEN/CLOSE

3. AUTO CLEANING

◆ SELECT ⇒ [●ENTER] PUSH

Set whether or not to clean the wand automatically

**Auto wand CLEAN**

---

Set whether or not to spray mist in the bowl unit automatically

**Auto bowl CLEAN**

---

Set whether or not to deodorize automatically after sitting on the toilet seat

**Deodorizer**

---

Set whether or not to power deodorize automatically after standing up

**Auto power deodorizer**

Remote control back side

**Items set on this display**

1. AUTO WAND CLEAN  
"Auto wand CLEAN"
2. AUTO BOWL CLEAN  
"Auto bowl CLEAN"
3. DEODORIZER  
"Deodorizer"
4. AUTO POWER DEODORIZER  
"Auto power deodorizer"

Menu, Return button

- Move the frame.
- Select the setting.
- Confirm the setting.

4 ▲  
▼ Select  
[AUTO WAND  
CLEAN]

AUTO CLEANING 1/4  
1.AUTO WAND CLEAN ◀ ON ▶  
2.AUTO BOWL CLEAN ON  
◀SELECT⇒[●ENTER] PUSH

5 ◀ ▶ Select  
[ON] or [OFF]

AUTO CLEANING 1/4  
1.AUTO WAND CLEAN ◀ OFF ▶  
2.AUTO BOWL CLEAN ON  
◀SELECT⇒[●ENTER] PUSH

Press

AUTO WAND CLEAN OFF

(To return→ □ ≡ / ↵)

4 ▲  
▼ Select  
[AUTO BOWL  
CLEAN]

AUTO CLEANING 2/4  
1.AUTO WAND CLEAN ON  
2.AUTO BOWL CLEAN ◀ ON ▶  
◀SELECT⇒[●ENTER] PUSH

5 ◀ ▶ Select  
[ON] or [OFF]

AUTO CLEANING 2/4  
1.AUTO WAND CLEAN ON  
2.AUTO BOWL CLEAN ◀ OFF ▶  
◀SELECT⇒[●ENTER] PUSH

Press

AUTO BOWL CLEAN OFF

(To return→ □ ≡ / ↵)

4 ▲  
▼ Select  
[DEODORIZER]

AUTO CLEANING 3/4  
2.AUTO BOWL CLEAN ON  
3.DEODORIZER ◀ ON ▶  
◀SELECT⇒[●ENTER] PUSH

5 ◀ ▶ Select  
[ON] or [OFF]

AUTO CLEANING 3/4  
2.AUTO BOWL CLEAN ON  
3.DEODORIZER ◀ OFF ▶  
◀SELECT⇒[●ENTER] PUSH

Press

DEODORIZER OFF

(To return→ □ ≡ / ↵)

4 ▲  
▼ Select  
[AUTO POWER  
DEODORIZER]

AUTO CLEANING 4/4  
4.AUTO POWER DEODORIZER  
◀ ON ▶  
◀SELECT⇒[●ENTER] PUSH

5 ◀ ▶ Select  
[ON] or [OFF]

AUTO CLEANING 4/4  
4.AUTO POWER DEODORIZER  
◀ OFF ▶  
◀SELECT⇒[●ENTER] PUSH

Press

AUTO POWER DEODORIZER  
OFF

(To return→ □ ≡ / ↵)

# Changing Settings

## Light

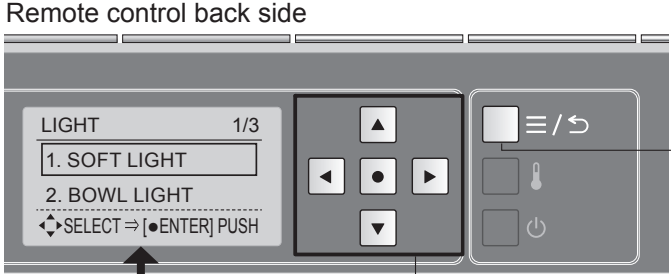
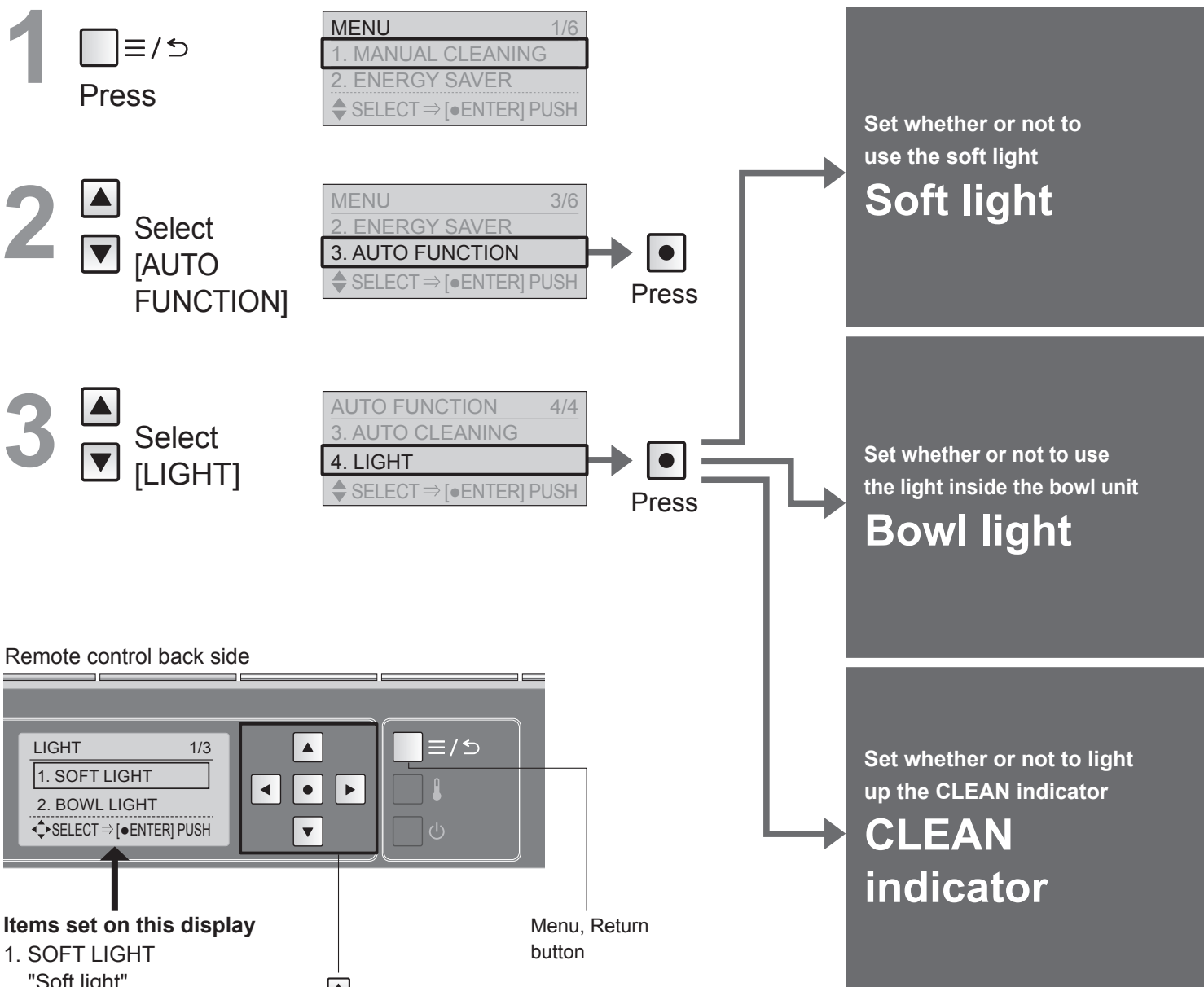

**Items set on this display**

- 1. SOFT LIGHT  
"Soft light"
- 2. BOWL LIGHT  
"Bowl light"
- 3. INDICATOR  
"CLEAN indicator"

- Move the frame.
  - 
  - Select the setting.
  - Confirm the setting.
- Menu, Return button

4   Select [SOFT LIGHT]

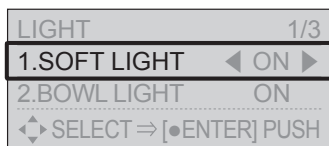

5   Select [ON] or [OFF]

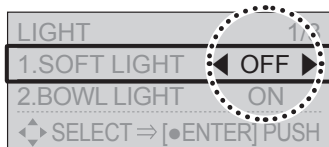



(To return →  ≡ / ↵)

4   Select [BOWL LIGHT]

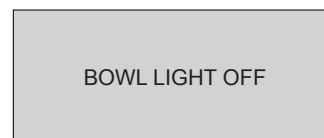
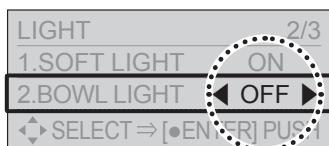

5   Select [ON] or [OFF]



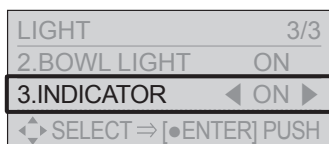

(To return →  ≡ / ↵)

4   Select [INDICATOR]

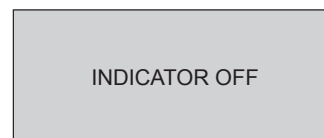
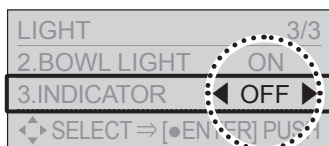

5   Select [ON] or [OFF]



(To return →  ≡ / ↵)

# Changing Settings

## Language settings

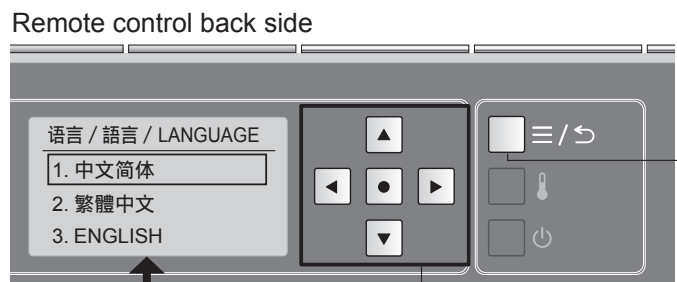
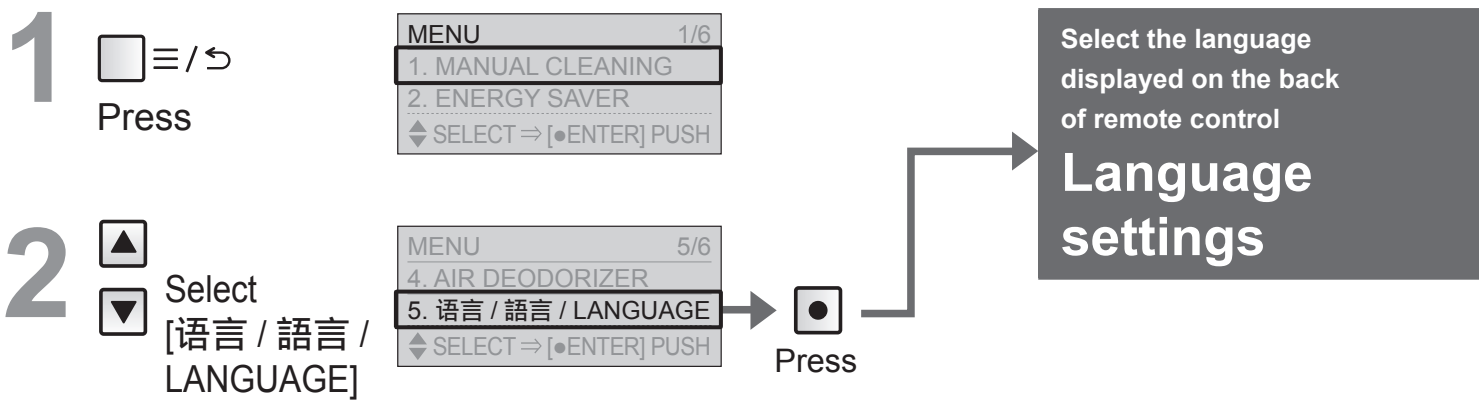

### Items set on this display

- 1. 中文简体  
"Simplified Chinese"
- 2. 繁體中文  
"Traditional Chinese"
- 3. ENGLISH  
"English"

- Move the frame.
- Move the frame.
- Confirm the setting.

Menu, Return button

3



Select  
[ 中文简体 ],  
[ 繁體中文 ] or  
[ ENGLISH ]

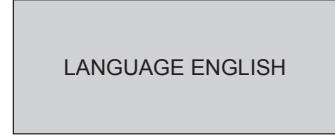

(To return → ≡ / ↵)

# Changing Settings

## Other settings

**1**    
Press

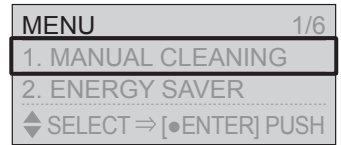

**2**  Select  
 [OTHER SETTING]



  
Press

Set whether or not to run the water for the bowl unit and top unit automatically at a fixed interval in order to prevent freezing  
**Anti freezing**

Set whether or not to make a beep sound  
**Beep sound**

Lowering the bowl unit water surface (For reducing water rebound, collecting a stool sample, etc.)  
Water surface lowering  
**Lower water level**

Set whether or not to keep your favorite pressure and position settings  
**Pressure/ position setting**



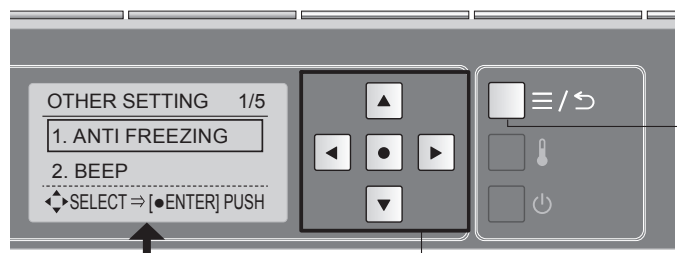

Set whether or not to use the personal setting lock  
**Personal setting lock**

Remote control back side



**Items set on this display**

- 1. ANTI FREEZING  
"Anti freezing"
- 2. BEEP  
"Beep sound"
- 3. LOWER WATER LEVEL  
"Lower water level"
- 4. PRESSURE/POSITION SETTING  
"Pressure/position setting"
- 5. PERSONAL SETTING LOCK  
"Personal setting lock"

-  Move the frame.
- 
-   Select the setting.
-  Confirm the setting.

Menu, Return button

3 ▲ Select [ANTI FREEZING]



4 ◀ ▶ Select [ON] or [OFF]

<For setting to [ON]> When the time is set, the bowl unit is cleaned in about 10 minutes intervals to prevent freezing.

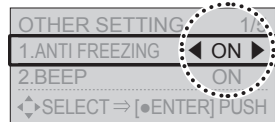

◀ ▶ Select [YES]

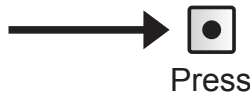

(To return → □ ≡ / ⏪)

3 ▲ Select [BEEP]



4 ◀ ▶ Select [ON] or [OFF]

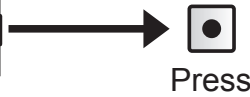
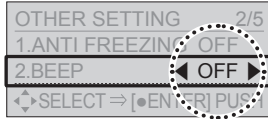

(To return → □ ≡ / ⏪)

3 ▲ Select [LOWER WATER LEVEL]

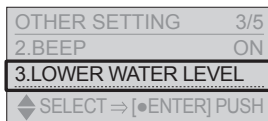

Press  
The water in the bowl unit flows and accumulates at a low water level.

**Note**

- The water level returns normal when the toilet is flushed. Please set this function each time you want to lower the water level.

3 ▲ Select [PRESSURE/ POSITION SETTING]

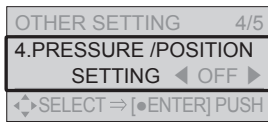

4 ◀ ▶ Select [ON] or [OFF]

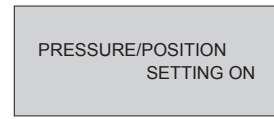
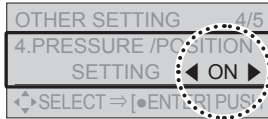

(To return → □ ≡ / ⏪)

3 ▲ Select [PERSONAL SETTING LOCK]



4 ◀ ▶ Select [ON] or [OFF]

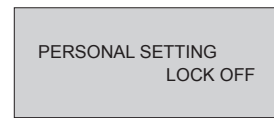
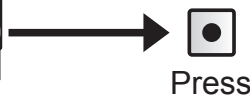

(To return → □ ≡ / ⏪)



# What to Do?

## If the water does not flow due to a power outage

### If the water does not flow due to a power outage (when water failure hasn't occurred)

#### ■ You can flush the toilet with the hand lever (for flushing in case of power outage).

- Pulling the hand lever does not flush the toilet when the power is supplied.
- When testing the operation, unplug the power plug.

**1** Remove the side panel (left).

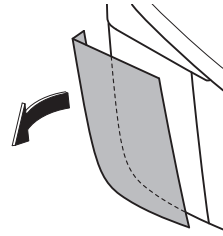

**2** Pull the hand lever to where it stops. (about 30 seconds)

- The water surface in the bowl rises.

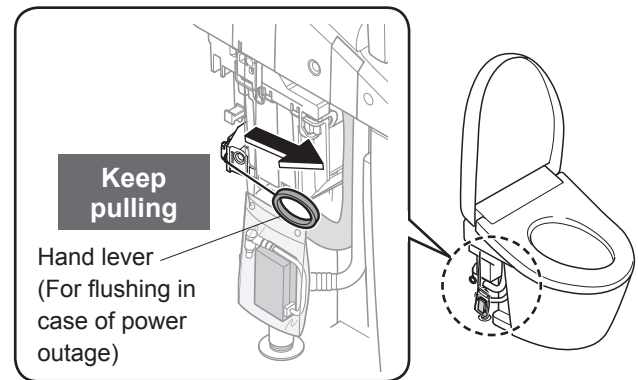

**3** When the beep sound is made and water supply stops, release the hand lever.

- The toilet flushes.
- You cannot flush the toilet for about 60 seconds after flushing it or releasing the hand lever halfway. Wait at least about 60 seconds and then flush the toilet again.

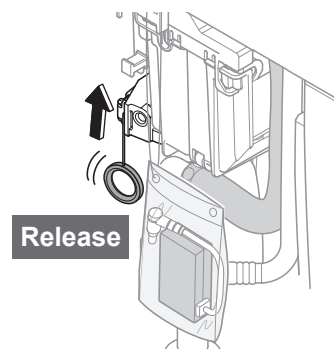

**4** Reinstall the side panel.

- Fit the side panel to the top and side of the bowl unit without a gap.

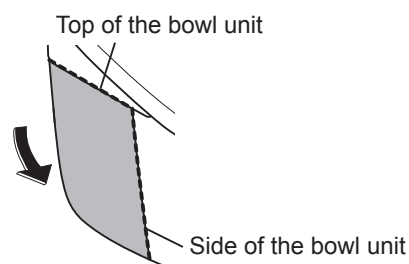

#### Attention!

- When the power is restored, be sure to perform a full flush. (To prevent waste from remaining in the discharge pipe.)

- You can flush the toilet with a bucket. (Page 58)

If power outage lasts for a long period (2 days or more), insert batteries in the battery box.

**Attention!**

- Be careful not to expose the battery box to water. (May cause malfunctions.)

**1** Remove the side panel (left).  
(Page 56)

**2** Take the battery box out of the bag.

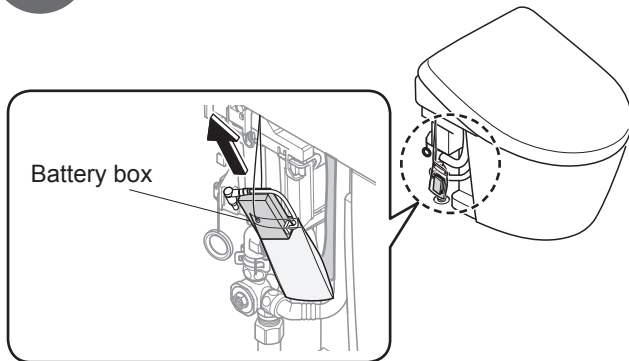

**3** Insert two AA batteries properly in the battery box.

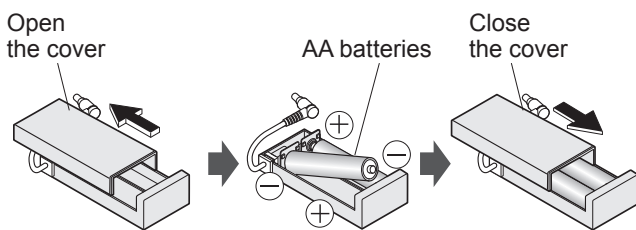

**4** Put the battery in the bag.

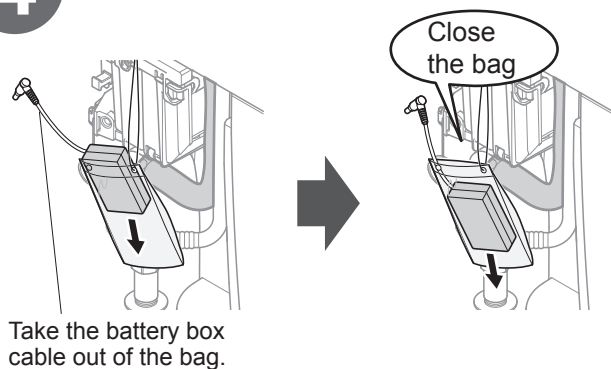

**5** Connect the battery box cable to the battery box plug socket.

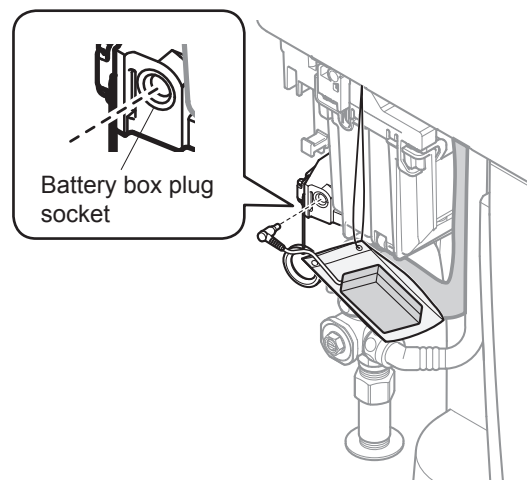

■ To flush the toilet with the hand lever  
(Page 56 Step 2 3)

- When the power outage recovers: unplug the battery box, take out the batteries, put the battery box cable inside the bag, and put back the side panel. (Page 56)

**■ About the batteries**

- Use dry cell, alkaline batteries.
- Be sure to follow "Safety Precautions" to prevent the batteries from rupturing or leaking fluid, etc. (Pages 6, 8)

# What to Do?

**If the water does not flow due to a water service interruption**

**If you cannot operate with the remote control**

**If the water does not flow due to a water service interruption**

**1** Use a bucket to flush water.

**2** If the water level is low after flushing, add more water.

- Prevents odors.

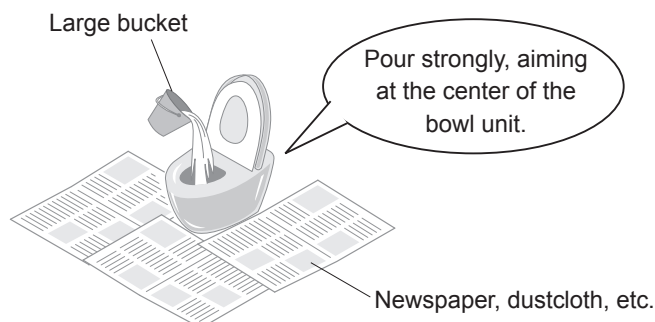

**Attention!**

- If there is a water supply failure, set "Auto flushing" to "OFF". (Page 44)
- When the water supply is restored, be sure to perform a full flush. (To prevent waste from remaining in the discharge pipe.)

**If you cannot operate with the remote control**

■ Flush is also possible using the buttons on the left side of top unit.

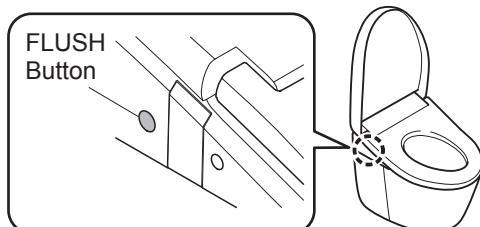

■ If the low battery warning LED is flashing, replace the batteries.

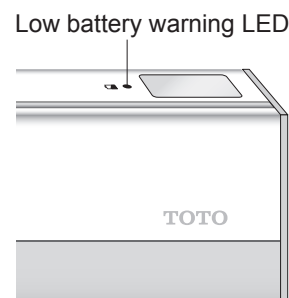

**■ Replacing the batteries**

**1** Unplug the power plug.

**2** Remove the remote control from the hanger.  
(Page 16)

**3** Open the battery cover and replace two AA batteries. (Page 16)  
• The low battery warning LED goes off.

**4** Mount the remote control in the hanger.

**5** Insert the power plug.  
• The "Power" LED lights up.

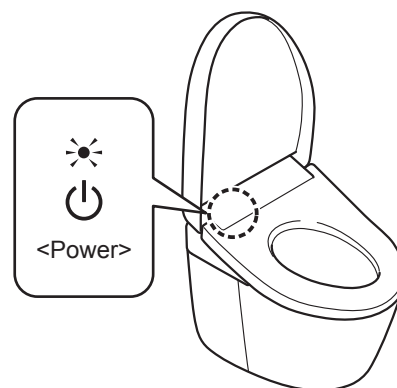

**Attention!**

- "ON" and "OFF" settings of the functions such as the energy saver function may be canceled when the batteries are replaced. Set them again.

# Freeze Damage Prevention

When the ambient temperature is likely to drop to 32°F (0°C) or lower, take measures to prevent freezing.

## Attention!

- When the ambient temperature is likely to drop to 32°F (0°C) or lower, do not use the energy saver feature. (May damage the product.)
- Warm the bathroom or take measures against freezing so that the ambient temperature does not drop below 32°F (0°C).
- Before starting to work, set "Auto flushing" (Page 44) and "Auto open/close" (Page 46) to "OFF".

## How to Freeze Damage Prevention (Dynamic mode)

This method runs the water for the bowl unit and top unit automatically at a fixed interval in order to prevent freezing.

### ■ How to Set (Page 54)

- Switch "Anti freezing" to "ON" with the remote control.

While Anti freezing is set to ON, it works as follows.

- The "Power" LED flashes.
- The toilet flushes at intervals of about 10 minutes.
- About 1.69 oz (about 50 ml) of water comes out from near the wand at intervals of about 5 minutes. (The wand remains retracted.)

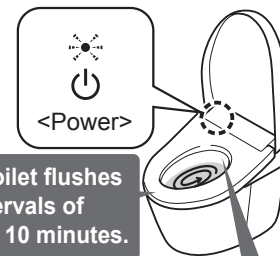

The toilet flushes at intervals of about 10 minutes.

Water comes out from near the wand at intervals of about 5 minutes.

# What to Do?

## Long Periods of Disuse

If the toilet is in a location you will not visit for a long time, drain the water.

(The water in the tank may cause malfunctions or become contaminated and cause skin irritation or other problems.)

(May cause freezing and damage to product.)

### CAUTION

- Do not drain water when the top unit is lifted up with the "Cleaning lift" (Page 36).

### How to drain the water

**1** Close the shutoff valve. (Page 63)

- The water supply stops.

### CAUTION



**Do not remove the water filter drain valve while the shutoff valve is open.**  
(Otherwise, water may leak out.)

**2**  Press "Full flush" button on the remote control to drain the tank.

**3**  Press "Wand CLEAN" button.

- The wand cover opens.  
(Release the pressure from the water supply pipe.)

**4** Unplug the power plug.

**5** Drain the pipe.

(1) Remove the cover and water filter drain valve.

- Loosen the water filter drain valve with a flat-head screwdriver and then pull it.

(2) After draining the water, install the water filter drain valve and cover.

- Insert the water filter drain valve and use a flat-head screwdriver to tighten it securely.

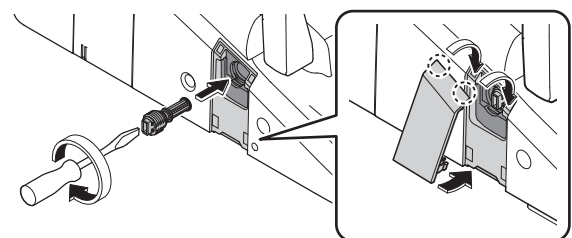
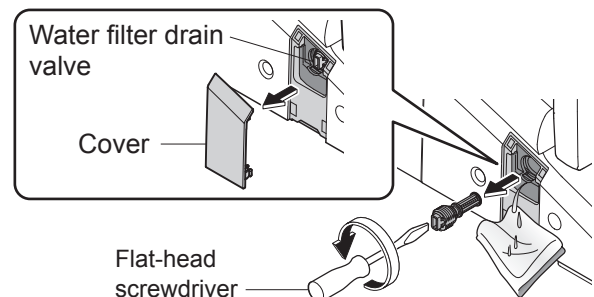

**6** Pull out the water drain lever.

- Water comes out from around the wand (about 20 seconds).

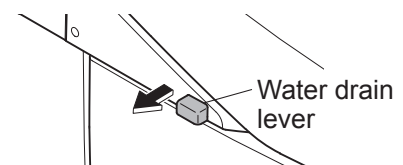

**7** Release your hand to return the water drain lever to its original position.

### ■ If water may get frozen

- Add antifreeze solution in the water in the bowl to prevent freezing.  
(The antifreeze solution should not be flushed out. Collect it before using the toilet and dispose of it.)

### ■ To use the product again

- The water needs to be resupplied. (Page 61)

## Resupplying the Water

**1** Open the shutoff valve. (Page 17)  
• Check that water is not leaking from a pipe or the top unit.

**2** Insert the power plug.  
• The "Power" LED lights up.

**3** ① Discharge water from the wand.  
(1) Pressing down the left side of the toilet seat,  
(2)  Press "Rear cleansing" button to discharge water from the wand.  
• Catch the water in a paper cup or other receptacle.  
(3) ■ Press "Stopping" button.

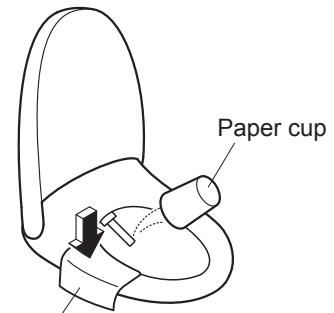

Soft cloth soaked in water  
(to prevent scratching)

②  Press "Full flush" button.

- The toilet flushes while the tank fills with water. The LED on the main display flashes. It stays lit after the tank becomes full (about 80 seconds max.).
- You cannot flush the toilet until water supply is complete. Never operate the toilet while the tank is filling with water.

■ **If the remaining water has frozen and no water comes out**

- Heat the inside of the bathroom, and warm the water supply hose and shutoff valve using a cloth soaked in warm water.

**4** After the bowl unit fills with water, press  ("Full flush" button) again.

# What to Do?

## Removal of Operation Guide

Follow the procedure below.

### How to remove the operation guide

- 1 Unplug the power plug.
- 2 Remove the remote control from the hanger.  
(Page 16)
- 3 Remove the hanger and operation guide.

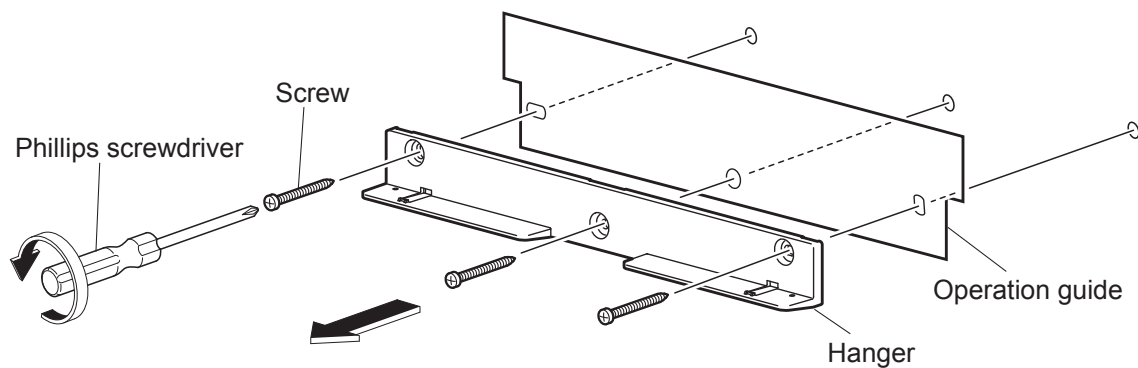

- 4 Screw the hanger on the wall.

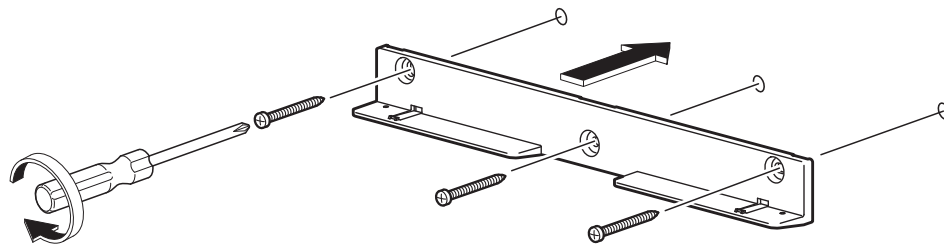

- 5 Mount the remote control in the hanger.
- 6 Insert the power plug.  
• The "Power" LED lights up.

■ To install back the operation guide, follow the procedure above.  
(Install the operation guide at step 4.)

# Troubleshooting

First, try the actions described on pages 63 - 70.

If the problem persists, consult the installer, seller, or TOTO customer service (see contact information on the back cover).

In the following case, unplug the power plug and consult with TOTO customer service (see contact information on the back cover).

- "Power" LED, "Seat" LED, and "Energy saver" LED are flickering

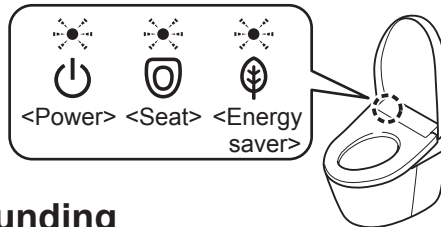

- The beep sound keeps sounding

**CAUTION**

**!** If a water leak occurs, close the shutoff valve.

## Please check first

### Is the Power LED lit?

- Is the "Power ON/OFF" setting "OFF"?

→ Switch it to "ON" with the remote control. (Page 17 Step 2-2)

- Is the "Power" LED on the main display flashing?

→ The "Anti freezing" is set to "ON". (Pages 54, 59)

- Is the breaker on the distribution board turned on?

→ Check whether there is a power outage or the breaker has turned "OFF".

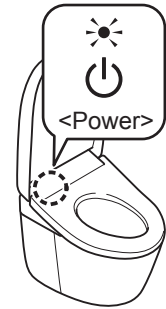

### Is the Energy saver LED lit?

- While the LED is lit, energy saver (Page 28) is in operation, so the toilet seat temperature may be reduced or the heater may be turned off.

### Is the remote control working?

- Is the low battery warning LED on the top surface of the remote control flashing?

→ Replace the batteries. (Pages 16, 58)

- Is the remote control transmitter or the remote control receiver blocked?

→ Remove obstructions, dirt, water droplets or any other blockages.

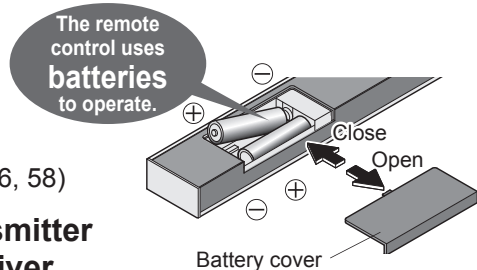

Remote control transmitter

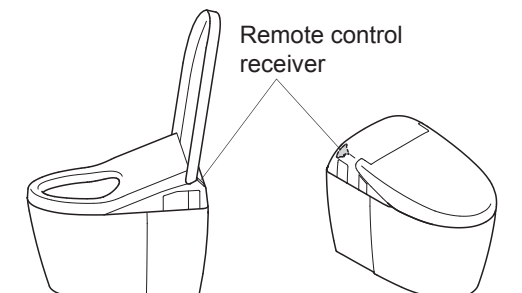
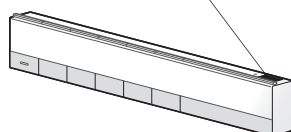



<The drawing is AH>

<The drawing is RH>



# Troubleshooting

## Rear Cleansing, Front Cleansing and Wand

Trouble	Please check	Ref. Page
The wand (or cleansing water) does not come out	<ul style="list-style-type: none"> <li>● When the temperature is low, it takes time for the wand to come out after the remote control button is pressed because the water must be warmed up first.</li> </ul>	-
	<ul style="list-style-type: none"> <li>● Did you sit on the toilet continuously for 2 hours or longer? (If so, operation is stopped for safety purposes.) → Stand up from the seat and then use again.</li> </ul>	-
	<ul style="list-style-type: none"> <li>● If the water supply pressure drops significantly, for example if water is used elsewhere or if there is a water failure, the function may stop for safety. → Unplug the power plug and wait about 10 seconds before inserting it again. If the same symptom reappears. → There may be a malfunction. Consult with TOTO customer service (see contact information on the back cover).</li> </ul>	-
	<ul style="list-style-type: none"> <li>● The seat switch will not turn on unless you sit on the seat properly. → Sit back on the toilet seat.</li> </ul>	11
	<ul style="list-style-type: none"> <li>● Are you using a toilet seat cover, a toilet lid cover or a seat for infants? → Remove any covers. When using a seat for infants or a soft highchair, remove after each use.</li> </ul>	 11
	<ul style="list-style-type: none"> <li>●  Are you pressing "Wand CLEAN" button?             <ul style="list-style-type: none"> <li>•  When you press "Wand CLEAN" button, "ewater+" comes out from the vicinity of the wand to clean the wand. → To clean the wand with it extended, perform "Wand cleaning".</li> </ul> </li> </ul>	38
The wand extends but the cleansing water does not come out/ The cleansing water pressure is weak	<ul style="list-style-type: none"> <li>● Has a water failure occurred? → <input type="checkbox"/> Press "Stopping" button on the remote control and wait until water service is restored.</li> </ul>	-
	<ul style="list-style-type: none"> <li>● Is the shutoff valve closed? → Fully open the shutoff valve.</li> </ul>	17
	<ul style="list-style-type: none"> <li>● Is the water filter drain valve clogged with foreign matter? → Clean the filter.</li> </ul>	39
	<ul style="list-style-type: none"> <li>● Is the water pressure set to a low level?</li> </ul>	18
The cleansing water is cold	<ul style="list-style-type: none"> <li>● Is the warm water temperature set to "OFF" or a low level?</li> <li>● When the temperature of the water supply or the bathroom is low, the water temperature may be low when first sprayed.</li> </ul>	26 -
	<ul style="list-style-type: none"> <li>● "Rear cleansing", "Rear soft cleansing", "Front cleansing", and "Wide front cleansing" stop automatically after about 5 minutes of continuous use.</li> <li>● Does the seat switch have difficulty detecting? → Sit back on the toilet seat. If you get up slightly from the seat, or sit forward on the seat, the seating switch may temporarily stop detecting your presence.</li> </ul>	- 11
Water comes out unexpectedly from the wand	<ul style="list-style-type: none"> <li>● Is the "Power" LED (green) on the main display flashing?             <ul style="list-style-type: none"> <li>• The "Anti freezing (dynamic mode)" is set to "ON". (Water comes out from near the wand at about 5 minutes intervals and the bowl unit flushes at about 10 minutes intervals.)</li> </ul> </li> <li>● When you sit on the toilet seat, water comes out for several seconds while water is warmed up.</li> <li>● Has the CLEAN indicator lit up in a cycle?             <ul style="list-style-type: none"> <li>• "Auto wand CLEAN" starts and the wand is cleaned.</li> </ul> </li> </ul>	54,59 - 22

## Warm air drying

Trouble	Please check	Ref. Page
The dryer temperature is low	● Is the dryer temperature set to low level?	26
Stops in the middle of use	● The feature stops automatically after about 10 minutes of continuous use.	-
	● Does the seat switch have difficulty detecting? → Sit back on the toilet seat. If you get up slightly from the seat, or sit forward on the seat, the seating switch may temporarily stop detecting your presence.	11

## Flushing

Trouble	Please check	Ref. Page
For not flushing	● Is the shutoff valve fully open?	17
	● Has a power outage occurred? → You can flush the toilet with the hand lever (for flushing in case of power outage).	56
	● Has a water failure occurred? → Use a bucket to flush water.	58
The toilet does not flush even when the button of remote control is pressed	● Is the LEDs on the main display flashing? • The tank is filling with water. (This takes about 60 seconds maximum.)	-
The bowl unit does not clean automatically or timing is delayed (Auto flushing)	● Is "Auto flushing" set to "OFF"? → Set to "ON".	44
	● Even if "Auto flushing" is set to "ON", it is not available in the following instances. • About 60 seconds after the toilet is flushed. → Wait about 60 seconds and flush the toilet with the remote control.	19
	• When the time spent sitting on the toilet seat or standing in front of the bowl unit is less than about 6 seconds. → Flush with the remote control.	19
	• When staying in front of the bowl unit after standing and using the toilet. → The water flows after a maximum of about 20 seconds from when you leave the bathroom.	-
	● The seat switch will not turn on unless you sit on the seat properly. → Sit back on the toilet seat.	11
	● The timing for the "Auto flushing" can be changed. (After about 10 seconds → after about 5 or 15 seconds)	44
The toilet flushes on its own	● Is "Auto flushing" set to "ON"? → You can turn it "OFF".	44
	● Does the seat switch or the body sensor have difficulty turning on or detecting? → Sit back on the toilet seat. If you lift your hip off the toilet seat during use or sit forward on it, the seat switch may not turn on, and thus auto flushing may occur during use.	11
	● Is the "Power" LED (green) on the main display flashing? • The "Anti freezing (dynamic mode)" is set to "ON". (Water comes out from near the wand at about 5 minutes intervals and the bowl unit flushes at about 10 minutes intervals.)	54,59
Waste material does not flush down completely	● Is the shutoff valve fully open?	17
	● Is the water filter clogged? → Clean the filter.	40
	● Is the water supply to the toilet disrupted by other running water fixtures? → Cease using other fixtures and then flush the toilet.	-

# Troubleshooting

Flushing		
Trouble	Please check	Ref. Page
Waste material does not flush down completely	<ul style="list-style-type: none"> <li>● Are the flush and light flush buttons being used correctly?                             <ul style="list-style-type: none"> <li>• (for solid waste) : up to 33 ft (10 m) of toilet paper (single)</li> <li>• (for liquid waste): up to 10 ft (3 m) of toilet paper (single)</li> </ul> </li> </ul>	19
	<ul style="list-style-type: none"> <li>● Flushing may be difficult depending the consistency of the waste material.                             <ul style="list-style-type: none"> <li>→ Flush the toilet again. If the bowl unit is not cleansed with a flushing, remove the stains with a brush or similar instrument.</li> </ul> </li> </ul>	34
	<ul style="list-style-type: none"> <li>● When the tank is filling, you cannot flush the toilet.                             <ul style="list-style-type: none"> <li>→ Once the "Power" LED on the main display are lit and the tank fills up with water, flush the toilet.</li> </ul> </li> </ul>	-
A small amount of water flows into the bowl unit after the unit flushes	<ul style="list-style-type: none"> <li>● If the water supply pressure drops significantly, for example if water is used elsewhere or if there is a water failure, water is supplied so that the water surface in the bowl unit rises to a certain level. If the same symptom reappears. → There may be a malfunction. Consult with TOTO customer service (see contact information on the back cover).</li> </ul>	-
Some barium remains after flushing	<ul style="list-style-type: none"> <li>● It may be difficult to flush down substances with a higher specific gravity than water, such as barium.                             <ul style="list-style-type: none"> <li>→ Flush the toilet again. If the bowl unit is not cleansed by flushing, remove the stains with a brush or similar instrument.</li> </ul> </li> </ul>	34
There is residue on the bowl unit surface	<ul style="list-style-type: none"> <li>● Oil and other hard-to-see grime may stick to the bowl unit surface.                             <ul style="list-style-type: none"> <li>→ Clean with (non-abrasive) neutral toilet detergent.</li> </ul> </li> </ul>	34
Pulling the hand lever (for flushing in case of power outage) does not flush the toilet	<ul style="list-style-type: none"> <li>● Pulling the hand lever does not flush the toilet when the power is supplied. When testing the operation, unplug the power plug.</li> </ul>	-
	<ul style="list-style-type: none"> <li>● To flush the toilet with the hand lever, keep pulling the lever until the beep sound is made and water supply stops.</li> </ul>	56
	<ul style="list-style-type: none"> <li>● You cannot flush the toilet for about 60 seconds after flushing it with the hand lever or releasing the hand lever halfway.                             <ul style="list-style-type: none"> <li>→ Wait at least about 60 seconds and then flush the toilet again.</li> </ul> </li> </ul>	-
	<ul style="list-style-type: none"> <li>● If power outage lasts for a long period (2 days or more), insert batteries in the battery box.</li> <li>● If the toilet does not flush with batteries in the battery box, the batteries are running out.                             <ul style="list-style-type: none"> <li>→ Replace them with new ones.</li> </ul> </li> </ul>	57

Toilet Seat and Toilet Lid (Auto open/close)		
Trouble	Please check	Ref. Page
The toilet lid does not open automatically	<ul style="list-style-type: none"> <li>● Is "Auto open/close" set to "OFF"? → Set to "ON".</li> <li>● Even when set to "ON", "Auto open/close" is not performed for about 15 seconds after the toilet seat or toilet lid is closed.                             <ul style="list-style-type: none"> <li>When the toilet lid is closed by hand (To make the product more user-friendly, a time interval is set from when the lid is closed to when it will open next.)</li> <li>→ Move away from the toilet and wait at least about 15 seconds before approaching the bowl unit again or open and close by hand.</li> </ul> </li> </ul>	46
	<ul style="list-style-type: none"> <li>● Is "Auto open delay" set to "30 seconds" or "90 seconds"?</li> </ul>	46
	<ul style="list-style-type: none"> <li>● After the power plug is inserted, the toilet lid does not open automatically for about 10 seconds.                             <ul style="list-style-type: none"> <li>→ Open and close by hand.</li> </ul> </li> </ul>	-
	<ul style="list-style-type: none"> <li>● Is a toilet lid or seat cover installed? → Remove any covers.</li> </ul>	11
	<ul style="list-style-type: none"> <li>● Detection by the body sensor may be difficult when the toilet is used by someone small, such as a child.</li> </ul>	-

## Toilet Seat and Toilet Lid (Auto open/close)

Trouble	Please check	Ref. Page
The toilet lid does not close automatically	<ul style="list-style-type: none"> <li>● Is "Auto open/close" set to "OFF"? → Set to "ON".</li> <li>● In the following cases, the toilet lid closes in about 5 minutes. <ul style="list-style-type: none"> <li>• When you did not sit on the toilet seat</li> <li>• When you sat on the toilet seat for less than 6 seconds</li> <li>• When you stood in front of the bowl unit for less than 6 seconds</li> </ul> </li> </ul>	46 -
The toilet lid opens on its own	<ul style="list-style-type: none"> <li>● Because the body sensor can detect movement through the wall or door in front of the toilet, the "Auto open/close" function may cause the toilet lid to open automatically even when you are outside of the bathroom. → You can also set "Auto open/close" to "OFF".</li> <li>● Is a urinal or wash basin also installed in the bathroom? → The body sensor may detect someone using the urinal, causing the toilet lid to open or close.</li> </ul>	46 -
The toilet lid closes on its own	<ul style="list-style-type: none"> <li>● Is "Auto open/close" set to "ON"? → You can turn it "OFF".</li> <li>● Is "Auto close delay" set to "25 seconds"?</li> <li>● The seat switch will not turn on unless you sit on the seat properly. → Sit back on the toilet seat.</li> </ul>	46 46 11
The toilet lid and toilet seat open at the same time	<ul style="list-style-type: none"> <li>● Is "Seat/lid" set to "Seat-lid"?</li> </ul>	46
Stops (or closes) while opening	<ul style="list-style-type: none"> <li>● If the lid or seat hits an obstruction the first time it opens after the power plug is inserted, it may stop (or close) partway during the next operation. → Eliminate any obstructions and unplug the power plug. Insert the power plug again after about 5 seconds. Then press  "Opening and closing the toilet seat" button.</li> </ul>	-
Cannot open or close with the remote control	<ul style="list-style-type: none"> <li>● If it opens automatically. → Check "Is the remote control working?"</li> <li>● If automatic opening does not work either <ul style="list-style-type: none"> <li>• The toilet lid may not be mounted correctly. → Mount them correctly.</li> </ul> </li> <li>● Incorrect detection may occur when operating under fluorescent lights.</li> </ul>	63 37 -

## Toilet Seat and Toilet Lid

Trouble	Please check	Ref. Page
The toilet seat is cold	<ul style="list-style-type: none"> <li>● Is the toilet seat temperature set to "OFF" or a low level?</li> </ul>	26
	<ul style="list-style-type: none"> <li>● Is energy saver in operation? <ul style="list-style-type: none"> <li>• The energy saver feature is on when the "Energy saver" LED is on and the "Power" LED is off on the main display. When you sit on the seat, the toilet seat heater is turned on temporarily and the seat is warmed in about 15 minutes. → You can turn it "OFF" if the energy saver feature is "ON".</li> </ul> </li> </ul>	28 30
	<ul style="list-style-type: none"> <li>● Have you been seated for a long time? <ul style="list-style-type: none"> <li>• After about 20 minutes of sitting, the temperature starts going down, and after about 1 hour, the toilet seat heater is turned "OFF". → Stand up from the seat and then use again.</li> </ul> </li> </ul>	-
	<ul style="list-style-type: none"> <li>● The seat switch will not turn on unless you sit on the seat properly. → Sit back on the toilet seat.</li> </ul>	11
	<ul style="list-style-type: none"> <li>● Is a toilet lid or seat cover installed? → Remove any covers.</li> </ul>	11

# Troubleshooting

## Energy Saver

Trouble	Please check	Ref. Page
The energy saver LED does not light up	<ul style="list-style-type: none"> <li>● Did you unplug the power plug or was there a power outage?               <ul style="list-style-type: none"> <li>• The "Energy saver" LED on the main display may go off when the power is turned on even if the energy saver feature is "ON". (It will turn on within about 24 hours since the setting is retained.)</li> </ul> </li> </ul>	-
The timer energy saver feature is not working	<ul style="list-style-type: none"> <li>● Did you replace the remote control batteries?               <ul style="list-style-type: none"> <li>• "Timer energy saver" may be canceled when the batteries are replaced.</li> <li>→ Set the timer energy saver again at the time you want to start it.</li> </ul> </li> </ul>	30
The auto energy saver+ or auto energy saver feature is not working	<ul style="list-style-type: none"> <li>● Because the function takes several days learning the usage conditions before starting energy saver, the amount of energy saving may be low, depending on the frequency of use.               <ul style="list-style-type: none"> <li>→ Check the energy saver setting.</li> </ul> </li> </ul>	28
	<ul style="list-style-type: none"> <li>● Did you replace the remote control batteries?               <ul style="list-style-type: none"> <li>• The settings may be canceled when the batteries are replaced.</li> <li>→ Set them again.</li> </ul> </li> </ul>	30

## Deodorizer

Trouble	Please check	Ref. Page
The deodorizer seems to be not working	<ul style="list-style-type: none"> <li>● Is "Deodorizer" set to "OFF"? → Set to "ON".</li> </ul>	48
	<ul style="list-style-type: none"> <li>● Even after sitting down, you do not hear operation sounds.               <ul style="list-style-type: none"> <li>→ Sit back on the toilet seat.</li> </ul> </li> <li>If you hear an operation sound from the deodorizer, but odors are not removed.               <ul style="list-style-type: none"> <li>→ Clean the deodorizing filter.</li> </ul> </li> </ul>	-
A strange odor is emitted	<ul style="list-style-type: none"> <li>● Are you using an air freshener or deodorizer that you purchased separately?               <ul style="list-style-type: none"> <li>• Doing so may reduce the effectiveness of the product's deodorizer or cause strange odors.</li> <li>→ Remove the air freshener or deodorizer.</li> </ul> </li> </ul>	-
The auto power deodorizer does not work	<ul style="list-style-type: none"> <li>● Is "Auto power deodorizer" set to "OFF"? → Set to "ON".</li> </ul>	48
	<ul style="list-style-type: none"> <li>● It starts about 10 seconds after you stand up from the toilet seat.</li> </ul>	-

## Sanitary

Trouble	Please check	Ref. Page
<b>The soft light, bowl light and CLEAN indicator do not light up</b>	<ul style="list-style-type: none"> <li>● Is the setting "OFF"? → Set to "ON".</li> <li>● If the CLEAN indicator LED is not lit, it is time to replace the component that generates "ewater+". Consult the installer, seller, or TOTO Customer Service. (see contact information on the back cover).</li> </ul>	50 -
<b>Pre-mist and after-mist do not work</b>	<ul style="list-style-type: none"> <li>● Is "Auto bowl cleaning" set to "OFF"? → Set to "ON".</li> <li>● The following functions do not work when the toilet seat is open.                             <ul style="list-style-type: none"> <li>• Is "Seat/lid" of "Auto open/close" set to "Seat•lid"? → You can change it to "Lid".</li> </ul> </li> <li>● The pre-mist does not work for about 90 seconds after the after-mist has finished.</li> </ul>	48 46 -
<b>The pre-mist sprays out spontaneously</b>	<ul style="list-style-type: none"> <li>● Because the body sensor can detect movement through the wall or door in front of the toilet, the "Auto bowl CLEAN" function may cause the toilet to pre-mist even when you are outside of the bathroom. → You can also set "Auto bowl CLEAN" to "OFF".</li> <li>● If the cleansing functions (e.g., Rear cleansing and Front cleansing) are not used for about 8 hours, "Auto bowl CLEAN" starts and mist is sprayed inside the bowl unit.</li> </ul>	48 23

## Others

Trouble	Please check	Ref. Page
<b>Water is leaking from the plumbing connections</b>	<ul style="list-style-type: none"> <li>● If any nuts in a connection are loose, firmly tighten them with a tool such as a monkey wrench. → If the water leak does not stop, close the shutoff valve and consult with TOTO customer service (see contact information on the back cover).</li> </ul>	-
<b>The display on the remote control goes out</b>	<ul style="list-style-type: none"> <li>● The display goes out when no button on the remote control is pressed for about 60 seconds or more.</li> </ul>	-
<b>The top unit is unstable</b>	<ul style="list-style-type: none"> <li>● There is clearance between the toilet seat cushion and the bowl unit for activating the seat switch. When you sit on the toilet seat, the toilet seat subsides slightly to activate the seat switch.</li> </ul>	11
<b>Water splashes up when using the toilet</b>	<ul style="list-style-type: none"> <li>● The water in the bowl unit that is used to mask the smell of excrement is the cause of the splashing. → Adding a layer of toilet paper on the surface of the water can slightly dampen splashing.</li> </ul>	-
<b>When flushing, you hear a squishing sound underneath the floor</b>	<ul style="list-style-type: none"> <li>● There are cases when the sound is made inside the discharge pipe because of the device to ensure water in the bowl unit after the unit flushes.</li> </ul>	-
<b>When flushing, you hear a gurgling sound</b>	<ul style="list-style-type: none"> <li>● When the toilet is flushed together with waste material, the sound is a result of air, waste material and water being pulled through the system.</li> </ul>	-

# Troubleshooting

Others		
Trouble	Please check	Ref. Page
<b>The top unit makes a sound</b>	When entering the bathroom ● If "Auto bowl CLEAN" is "ON", you may hear that pre-mist is spraying mist in the bowl unit to make it more difficult for dirt to adhere. → You can turn it "OFF".	48
	When using the cleansing functions (Rear cleansing, Soft rear cleansing, or Front cleansing) ● You can hear the sound of the pump operating while cleansing water is being supplied.	-
	When moving away from the bowl unit after use ● When "Auto power deodorizer" is "ON", operation sounds are made while the deodorizing power increases for 60 seconds after you stand up from the toilet seat. → You can turn it "OFF". ● If "Auto wand CLEAN" is "ON" and you use the cleansing functions (e.g., Rear cleansing and Front cleansing), you may hear that the wand is extended and cleaned with "ewater+". → You can turn it "OFF". ● If "Auto bowl CLEAN" is "ON" and you sit on the toilet seat and use the toilet, you may hear that mist of "ewater+" is sprayed inside the bowl unit. → You can turn it "OFF". ● You may hear that the wand is extended and the remaining water in the product is drained after "Auto wand CLEAN" and other functions are performed.	48
		48
		48
When not using the product (e.g., at night) ● You may hear the following sounds if "Auto wand CLEAN" or "Auto bowl CLEAN" is "ON" and if you do not use the cleansing functions (e.g., Rear cleansing and Front cleansing) for about 8 hours. "Auto wand CLEAN" : Sound of cleaning the wand with "ewater+" : Sound of extending the wand and draining remaining water from the product after operation of functions "Auto bowl CLEAN" : Sound of spraying mist of "ewater+" mist inside the bowl unit → You can turn it "OFF". ● Because the body sensor can detect movement through the wall or door in front of the toilet, the "Auto open/close" and "Auto bowl CLEAN" functions may cause the toilet to pre-mist, or the lid to open, even when you are outside of the bathroom. → You can also set "Auto open/close" or "Auto bowl CLEAN" to "OFF".	48	
46,48		
<b>You are not sure if the Air deodorizer has been set or not</b>	● Since this product does not include the "Air deodorizer" function, it cannot be set even if you operate the remote control.	-
<b>There are black stain on or around the bowl unit</b>	● Ammonia in urine may cause black stains. → If urine has splashed on the bowl unit or floor, wipe it immediately.	-
<b>There is black or pink slime on the toilet bowl surface</b>	● It is a result of growth of airborne fungal spores or bacteria that feed on filth on the toilet bowl. → Clean with (non-abrasive) neutral toilet detergent.	-
<b>There are water droplets on the bowl unit surface</b>	● Condensation occurs when the humidity is high, and there is a significant difference between water and room temperatures. → Wipe off droplets with dry cloth. (Condensation can build up on condensation-proof bowls when the difference between room and water temperatures exceeds 59°F (15°C) and the ambient humidity reaches 80%.)	-

# Specifications

Item			AH	RH	
Rated power supply			AC 120 V, 60 Hz		
Rated power consumption			1288 W		
Maximum power consumption			1443 W		
Type of water heater			Instantaneous type		
Power cord length			3.94 ft (1.2 m)		
Water protection level			IPX4		
Bowl unit	Flush volume		Full 1.0 gal (4.0 L) , Light 0.8 gal (3.0 L)		
	Water supply system		Direct supply, Pressurized supply		
	Flush type		Cyclone flushing		
	Bowl style		Elongated		
	Anti freezing	Dynamic mode	Flush volume (dynamic)	11.4 gal/h (43 L/h) <sup>*1</sup>	
Functions	Cleansing	Spray volume	Rear cleansing	Approx. 0.08 - 0.11 gal/min (Approx. 0.32 - 0.43 L/min) <at 29 PSI (0.20 MPa) water pressure>	
			Rear soft cleansing	Approx. 0.08 - 0.11 gal/min (Approx. 0.32 - 0.43 L/min) <at 29 PSI (0.20 MPa) water pressure>	
			Front cleansing	Approx. 0.08 - 0.11 gal/min (Approx. 0.29 - 0.43 L/min) <at 29 PSI (0.20 MPa) water pressure>	
			Wide front cleansing	Approx. 0.09 - 0.11 gal/min (Approx. 0.35 - 0.43 L/min) <at 29 PSI (0.20 MPa) water pressure>	
		Water temperature		Adjustable temperature range: OFF, about 86 - 104°F (about 30 - 40°C)	
		Heater capacity		1116 W	
		Safety device		Temperature fuse	
		Backflow prevention device		Vacuum breaker, Check valve	
	Heated seat	Surface temperature		Adjustable temperature range: OFF, about 82 - 97°F (about 28 - 36°C) (Auto energy saver: about 79°F (about 26°C) Auto energy saver+: OFF)	
		Heater capacity		50 W	
		Safety device		Temperature fuse	
	Deodorizer	Method		O <sub>2</sub> deodorization	
		Airflow volume		Normal mode: Approx. 3.17 ft <sup>3</sup> /min (Approx. 0.09 m <sup>3</sup> /min), Power mode: Approx. 5.65 ft <sup>3</sup> /min (Approx. 0.16 m <sup>3</sup> /min)	
		Power consumption		Normal mode: Approx. 1.7 W, Power mode: Approx. 5.3 W	
	Warm air dryer	Warm air temperature <sup>*2</sup>		Adjustable temperature range: about 95 - 140°F (about 35 - 60°C)	
		Airflow volume		Approx. 10.24 ft <sup>3</sup> /min (Approx. 0.29 m <sup>3</sup> /min)	
Heater capacity		347 W			
Safety device		Temperature fuse			
Water supply pressure			Minimum required water pressure: 7.25 PSI (0.05 MPa) <Dynamic, 2.6 gal/min (10 L/min)>, Maximum water pressure: 108.75 PSI (0.75 MPa) <Static>		
Water supply temperature			32 - 95°F (0 - 35°C)		
Working ambient temperature			32 - 104°F (0 - 40°C)		
Dimensions			W 1.27 x D 2.27 x H 1.81 ft (W 386 x D 691 x H 551 mm)	W 1.27 x D 2.26 x H 1.76 ft (W 386 x D 689 x H 535 mm)	
Weight			About 90 lb (about 41 kg) <Functions about 13 lb (about 6 kg), Bowl unit about 77 lb (about 35 kg)>		

\*1 The flush volume changes depending on water pressure.

\*2 Temperature around the warm air outlet measured by TOTO.

●When disposing of this product, please follow your local or state guidelines for proper disposal.



# Limited Warranty

## Three Years Limited Warranty

1. TOTO warrants its Neorest brand products to be free from defects in materials and workmanship during normal use when properly installed and serviced, for a period of three (3) years from date of purchase. This limited warranty is extended only to the ORIGINAL PURCHASER of the product and is not transferable to any third party, including but not limited to any subsequent purchaser or owner of the product. This warranty applies only to TOTO product purchased and installed in USA and Canada.
2. TOTO's obligations under this warranty are limited to repair, replacement or other appropriate adjustment, at TOTO's option, of the product or parts found to be defective in normal use, provided that such product was properly installed, used and serviced in accordance with instructions.  
TOTO reserves the right to make such inspections as may be necessary in order to determine the cause of the defect. TOTO will not charge for labor or parts in connection with warranty repairs or replacements. TOTO is not responsible for the cost of removal, return and/or reinstallation of the product.
3. This warranty does not apply to the following items:
  - a) Damage or loss sustained in a natural calamity such as fire, earthquake, flood, thunder, electrical storm, etc.
  - b) Damage or loss resulting from any accident, unreasonable use, misuse, abuse, negligence, improper care, or maintenance of the product.
  - c) Damage or loss resulting from sediments or foreign matter contained in a water system.
  - d) Damage or loss resulting from the quality of water in the region where the product is used.
  - e) Damage or loss resulting from improper installation or from installation of the product in a harsh and/or hazardous environment, or improper removal, repair or modification of the product. This includes locations where the water pressure is above local codes or standards. (NOTE : Product model codes allow a maximum of 80 PSI. Check local codes or standards for requirements).
  - f) Damage or loss resulting from electrical surges or lightning strikes or other acts which are not the fault of TOTO or which the product is not specified to tolerate, including failure to use the factory equipped cord and plug or use of a loose or faulty electrical outlet or use of a current or socket other than a 120V, 60Hz electrical current from a GFI (ground, fused) socket.
  - g) Damage or loss resulting from normal and customary wear and tear, such as gloss reduction, scratching or fading over time due to use, cleaning practices or water or atmospheric conditions, including but not limited to, the use of bleach, alkali, acid cleaners, dry (powder) cleaners or any other abrasive cleaners or the use of metal or nylon scrubbers.
4. If the Danger Label which has been placed over the seams on the back of the product's top unit is broken or otherwise not intact, this limited warranty is void.
5. In order for this limited warranty to be valid, proof of purchase is required. TOTO encourages warranty registration upon purchase to create a record of product ownership at <http://www.totousa.com>. Product registration is completely voluntary and failure to register will not diminish your limited warranty rights.
6. If the product is used commercially or is installed outside of USA and Canada, TOTO warrants the product to be free from defects in materials and workmanship during normal use for one (1) year from the date of installation of the product, and all other terms of this warranty shall be applicable except the duration of the warranty.
7. This warranty gives you specific legal rights. You may have other rights which vary from state to state, province to province or country to country.
8. To obtain warranty repair service under this warranty, you must take the product or deliver it prepaid to a TOTO service facility together with proof of purchase (original sales receipt) and a letter stating the problem, or contact a TOTO distributor or products service contractor, or write directly to TOTO U.S.A., INC., 1155 Southern Road, Morrow, GA 30260 (888) 295-8134 or (678) 466-1300, if outside the U.S.A. If, because of the size of the product or nature of the defect, the product cannot be returned to TOTO, receipt by TOTO of written notice of the defect together with proof of purchase (original sales receipt) shall constitute delivery. In such case, TOTO may choose to repair the product at the purchase's location or pay to transport the product to a service facility.

WARNING! TOTO shall not be responsible or liable for any failure of, or damage to, this product caused by either chloramines in the treatment of public water supply or cleaners containing chlorine (calcium hypochlorite).

NOTE: The use of a high concentrate chlorine or chlorine related products can seriously damage the fittings. This damage can cause leakage and serious property damage.

THIS WRITTEN WARRANTY IS THE ONLY WARRANTY MADE BY TOTO. REPAIR, REPLACEMENT OR OTHER APPROPRIATE ADJUSTMENT AS PROVIDED UNDER THIS WARRANTY SHALL BE THE EXCLUSIVE REMEDY AVAILABLE TO THE ORIGINAL PURCHASER. TOTO SHALL NOT BE RESPONSIBLE FOR LOSS OF THE PRODUCT OR FOR OTHER INCIDENTAL, SPECIAL OR CONSEQUENTIAL DAMAGES OR EXPENSES INCURRED BY THE ORIGINAL PURCHASER, OR FOR LABOR OR OTHER COSTS DUE TO INSTALLATION OR REMOVAL, OR COSTS OF REPAIRS BY OTHERS, OR FOR ANY OTHER EXPENSE NOT SPECIFICALLY STATED ABOVE. IN NO EVENT WILL TOTO'S RESPONSIBILITY EXCEED THE PURCHASE PRICE OF THE PRODUCT. EXCEPT TO THE EXTENT PROHIBITED BY APPLICABLE LAW, ANY IMPLIED WARRANTIES, INCLUDING THAT OF MERCHANTABILITY OR FITNESS FOR USE OR FOR A PARTICULAR PURPOSE, ARE EXPRESSLY DISCLAIMED. SOME STATES DO NOT ALLOW LIMITATIONS ON HOW LONG AN IMPLIED WARRANTY LASTS, OR THE EXCLUSION OR LIMITATION OF INCIDENTAL OR CONSEQUENTIAL DAMAGES, SO THE ABOVE LIMITATION AND EXCLUSION MAY NOT APPLY TO YOU.

# MEMO

# MEMO

# MEMO